

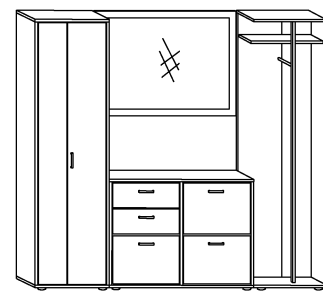

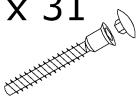

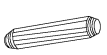

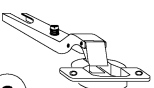

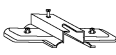
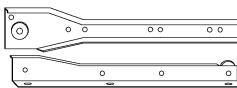
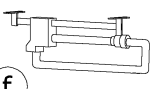
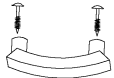







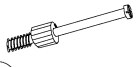

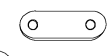

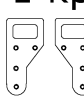

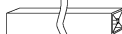



# PRZEDPOKÓJ 7

► 211 ↑ 198 ↘ 35

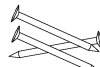

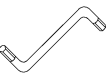
|  |   |  |  |  |  |  |  |  |  |
|--|---|--|--|--|--|--|--|--|--|
| x 31<br><br>a            | x 14<br><br>b            | x 6<br><br>c      | x 6<br><br>d  | x 2 kpl. (300 mm)<br><br>e |  |  |  |  |  |
| x 1 (300 mm)<br><br>f    | x 6<br><br>g             | x 3 kpl.<br><br>h |  | x 6<br><br>h1               | x 6<br><br>h2 | x 2<br><br>i          |   60 min  |  |  |
| x 11<br><br>j            | x 11<br><br>k            | x 3<br><br>l      | x 13<br><br>m | x 1 kpl.<br><br>n           |  | x 1<br>260 mm<br><br>o | x 1<br>280 mm<br><br>p  | x 1<br>1928 mm<br><br>r |  |
| x 74<br>(4x16)<br><br>s | x 8<br>(3,5x30)<br><br>t | x 4<br><br>u      | x 1<br><br>w  | x 24<br>(6,2x13)<br><br>x   | x 1<br><br>y  | x 2<br><br>z            | x 135<br><br>q   | x 2<br><br>v            | x 1<br><br> |

1 - FAZY MONTAŻU

A - OZNACZENIE ELEMENTÓW

a - OZNACZENIE AKCESORIÓW

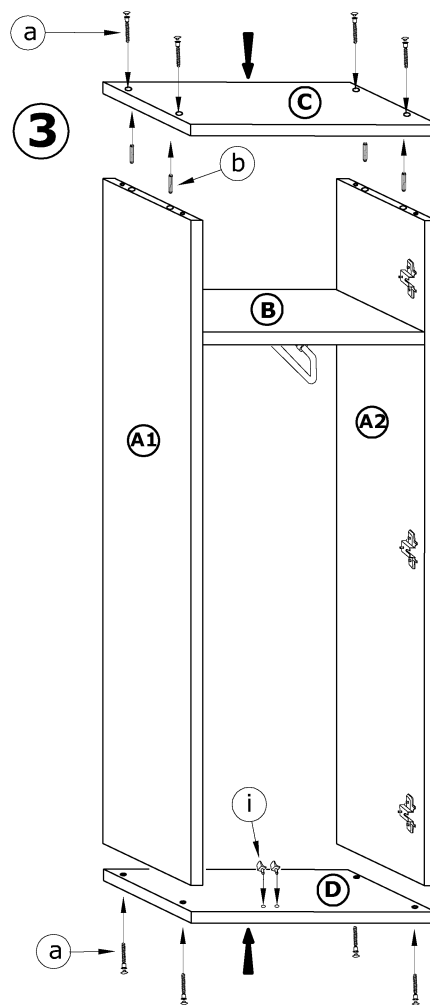
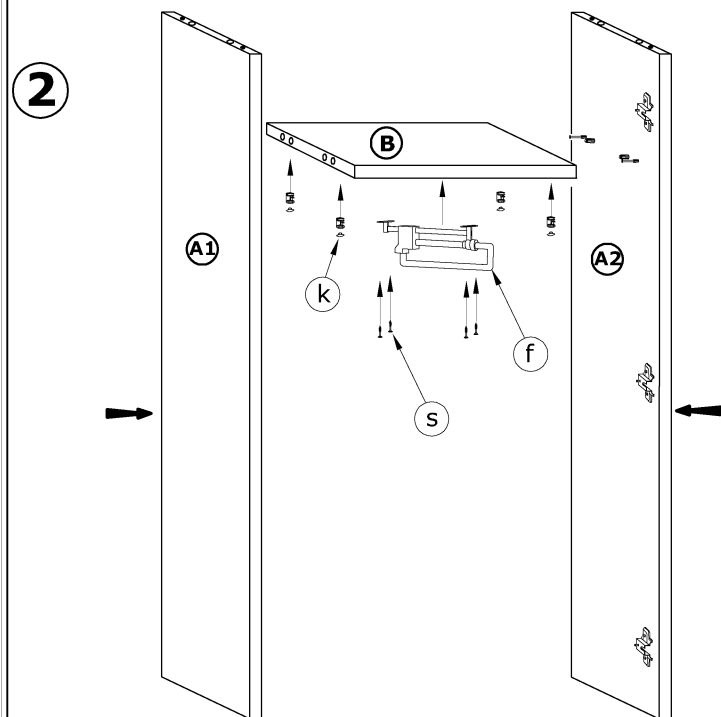
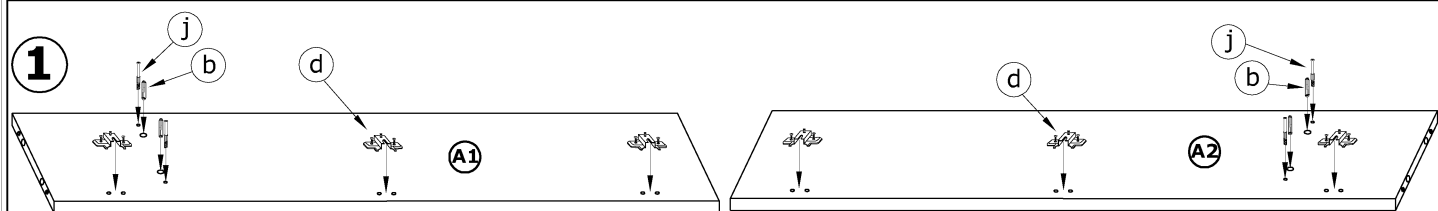

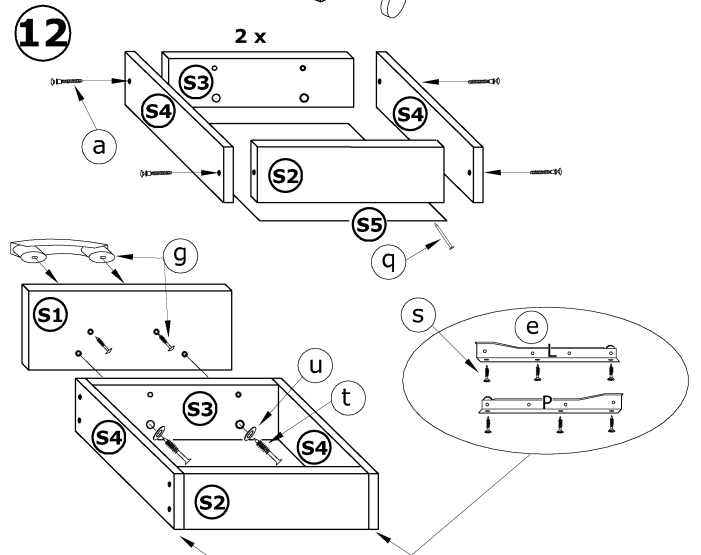
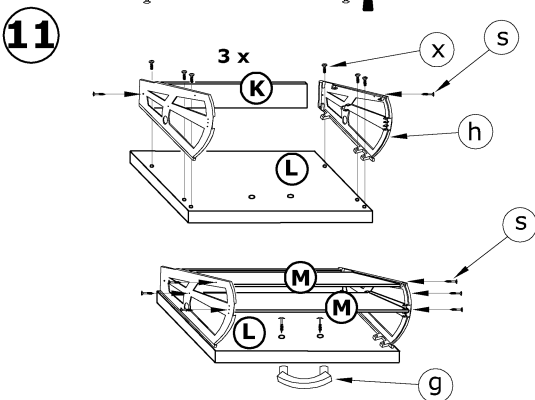
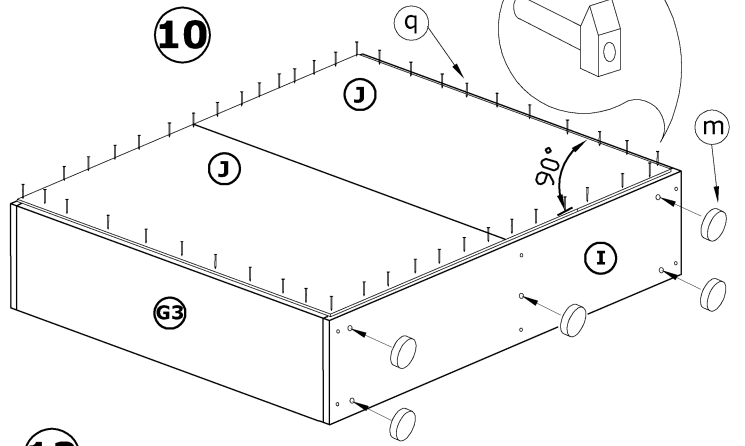
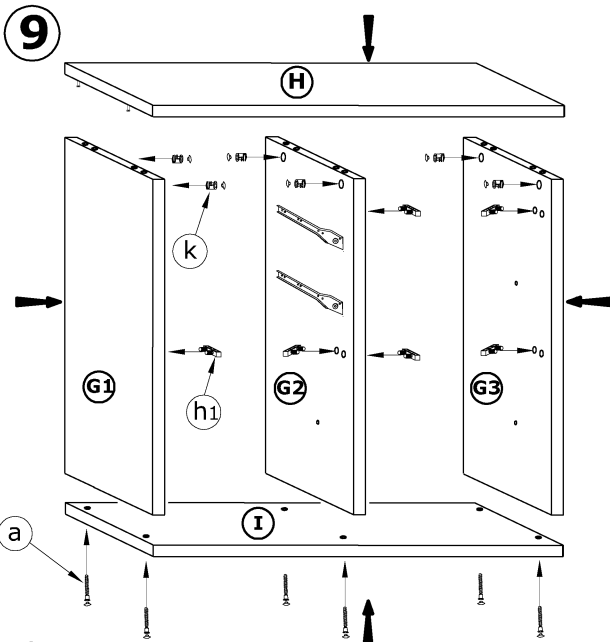
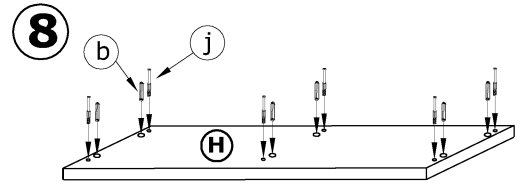
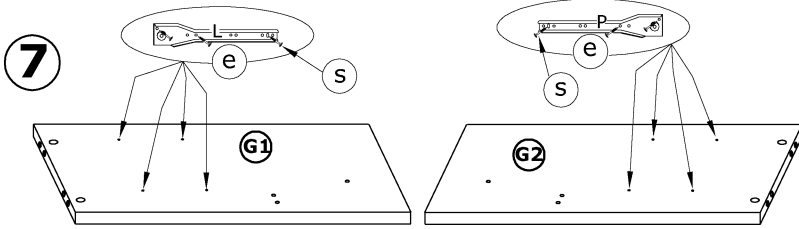
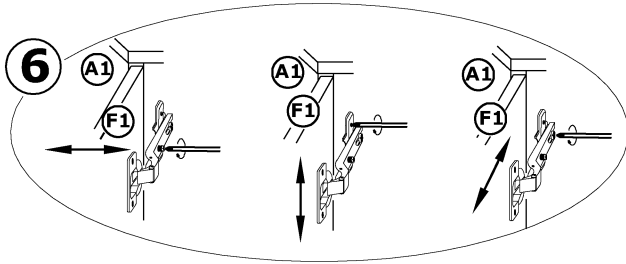
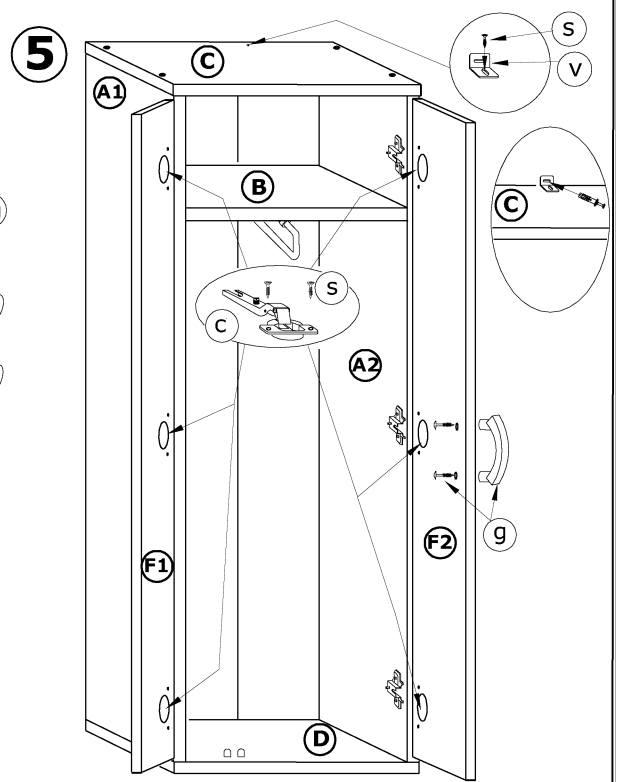
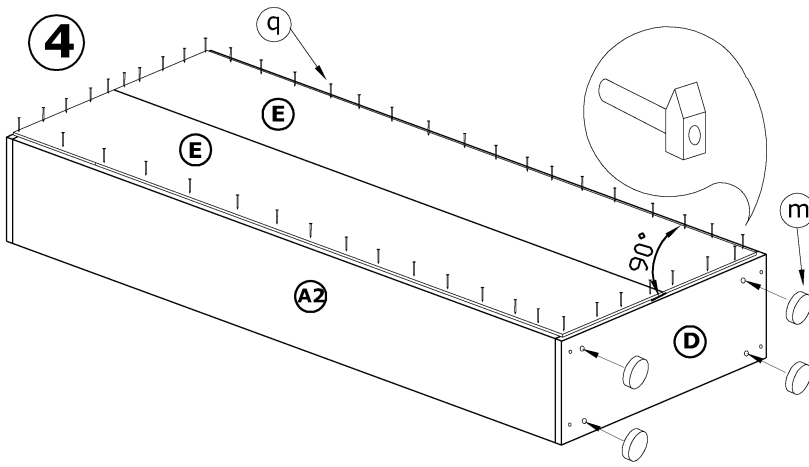

13

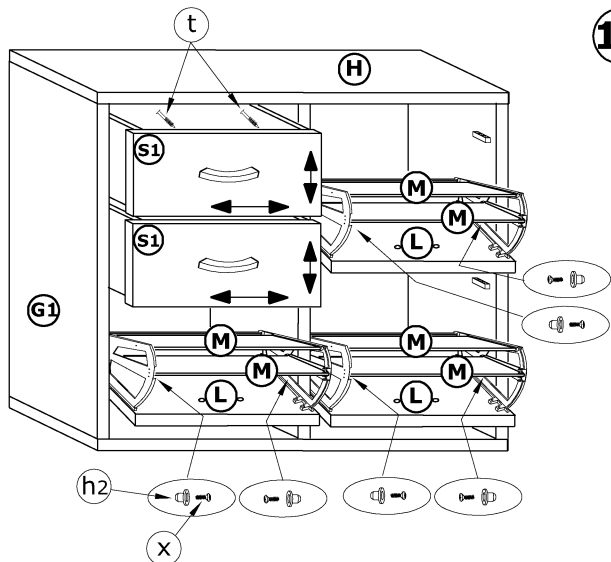

14

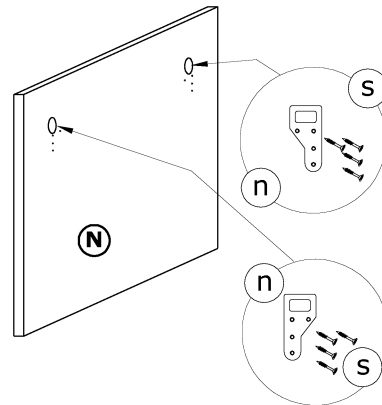

15

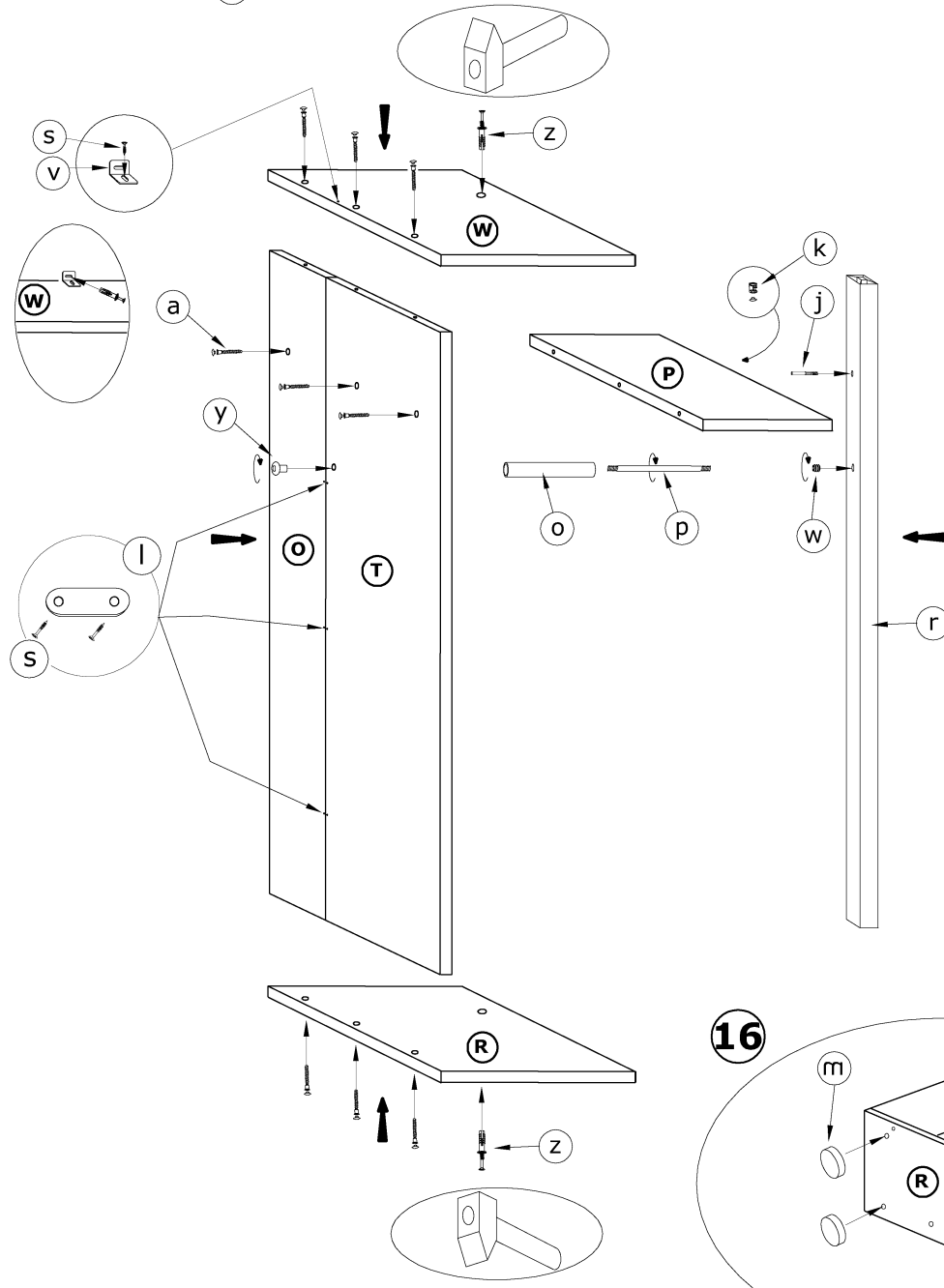

16

