

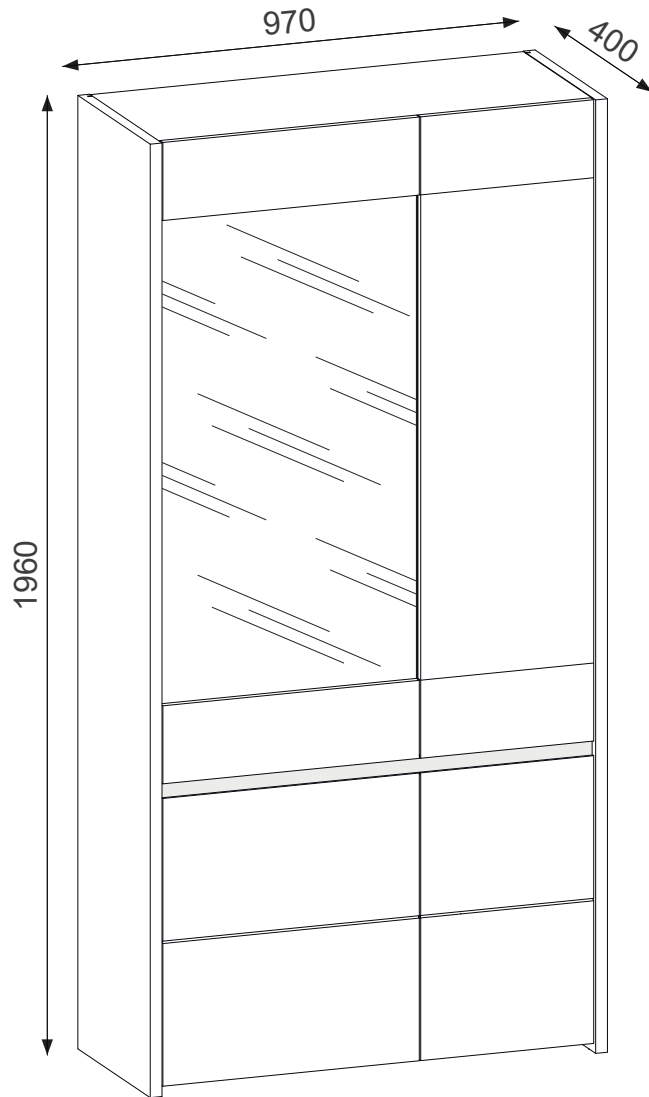

Modell **GB5/KS5**

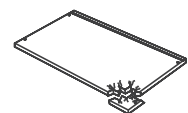

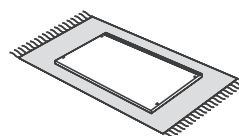

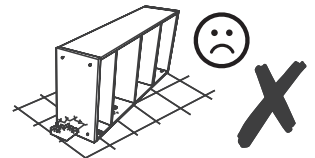
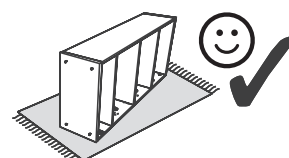
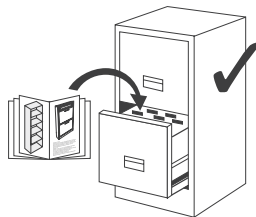
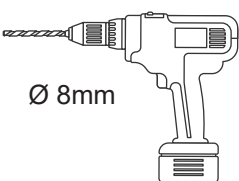
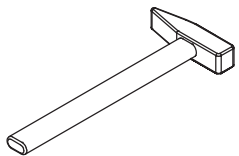
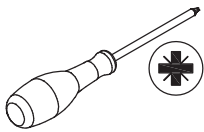
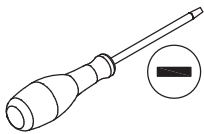
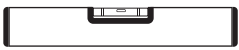
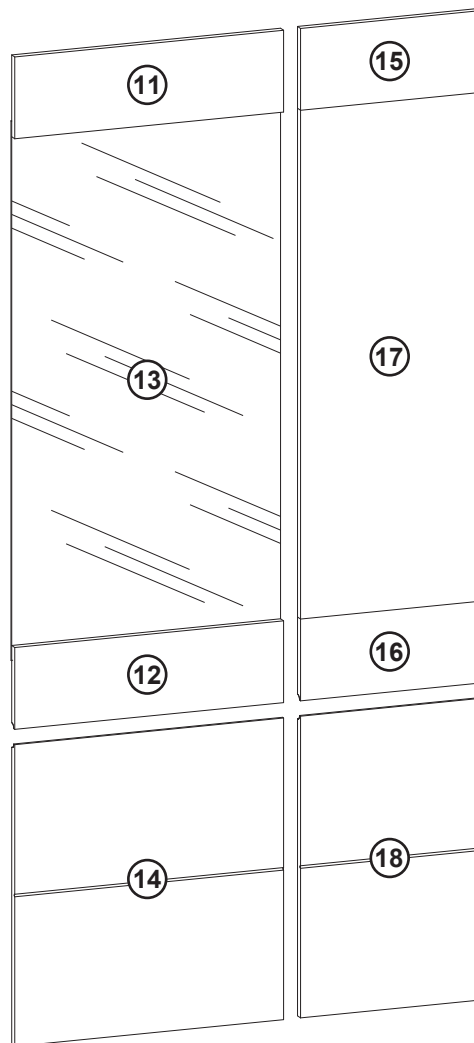
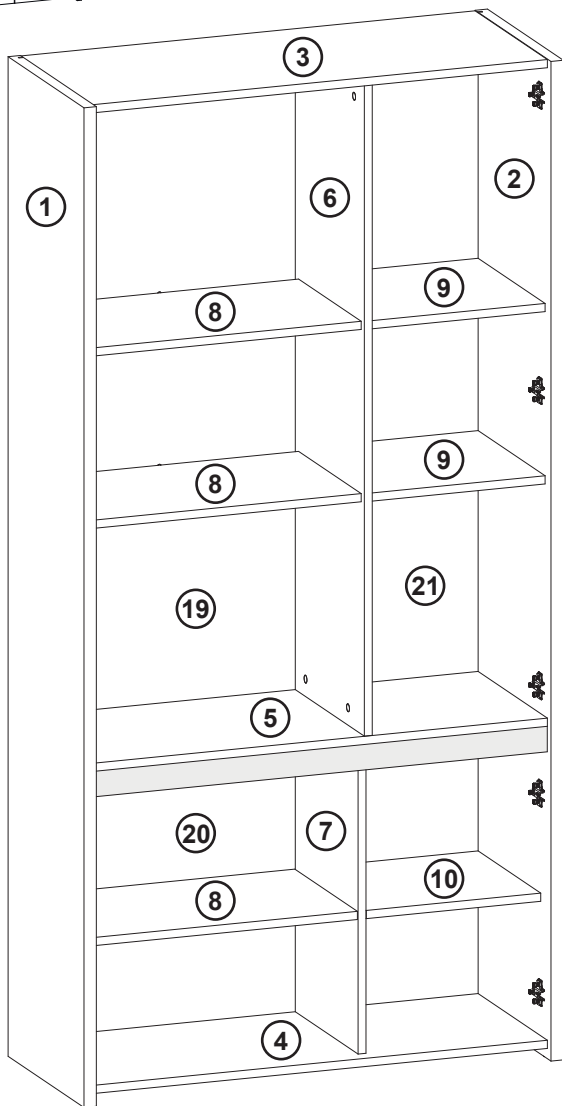
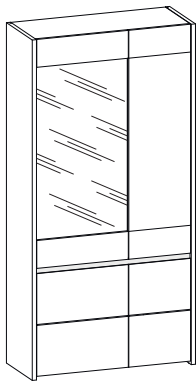



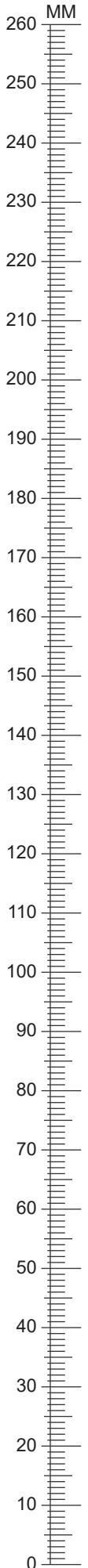
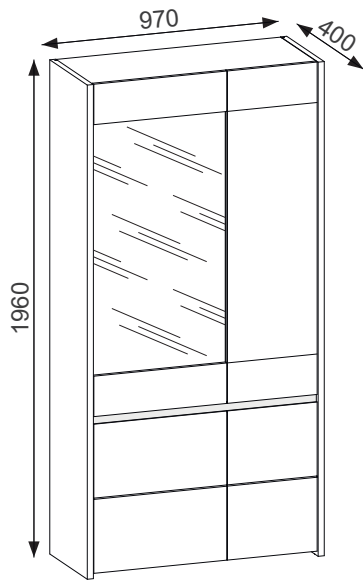





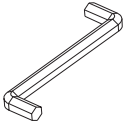
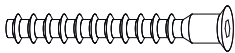
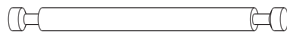
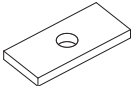





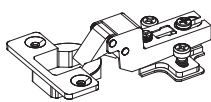
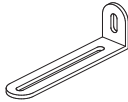

A	B (mm)		C	D
1	1955	400	25	x1 3/3
2	1955	400	25	x1 3/3
3	920	381	16	x1 1/3
4	920	365	16	x1 1/3
5	920	365	16	x1 1/3
6	1272	364	16	x1 2/3
7	614	331	16	x1 2/3
8	549	330	16	x2 1/3
8	549	330	16	x1 2/3
9	353	353	16	x2 1/3

A	B (mm)		C	D
10	353	330	16	x1 2/3
11	544	160	16	x1 2/3
12	544	160	16	x1 2/3
13	1055	544	4	x1 2/3
14	544	590	16	x1 2/3
15	367	160	16	x1 2/3
16	367	160	16	x1 2/3
17	367	995	16	x1 2/3
18	367	590	16	x1 2/3
19	1288	566	2,5	x1 2/3
20	638	566	2,5	x1 2/3
21	1926	369	2,5	x1 3/3

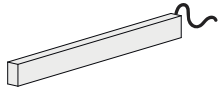

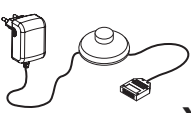
4x		k40
	Ø 15mm	
1x		k43
	25x45x45mm	

1x		z1	2x		e27	6x		r24
	4mm			Ø 6,3x50mm			L=84mm	
10x		n108	14x		r23	26x		r1
	L=20x10x2 mm			45mm			Ø 15x12mm	
16x		f1	2x		f2	4x		f3
	Ø 8x30mm			Ø 8x50mm			Ø 8x40mm	
8x		s1	8x		s7	24x		d1
	Ø 20mm			Ø 20mm			Ø 5mm	
9x		ab2	1x		n14/2	15x		l2
	Ø 35mm			L=75x25x15mm			10x10x15mm	
6x		r5	6x		d6	2x		d8
	Ø 6mm			10x6x10mm			Ø 8mm	
1x		x4/1	12x		p50	18x		p51
	L=920mm			Ø 3x16mm			Ø 3,5x16mm	
1x		x4/2	10x		p21	1x		p25
				Ø 4,2x16mm			Ø 4,2x25mm	

1

b2 x 9
40x50x12mm

r23 x 12
45mm

f1 x 4
Ø 8x30mm

r1 x 6
Ø 15x12mm

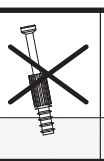
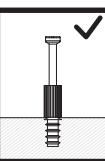
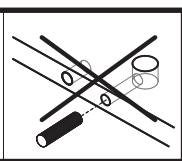
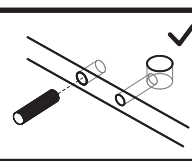
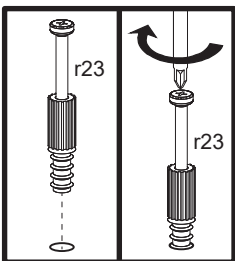
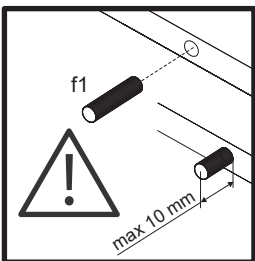
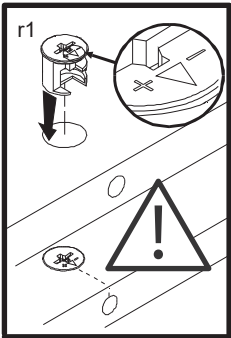
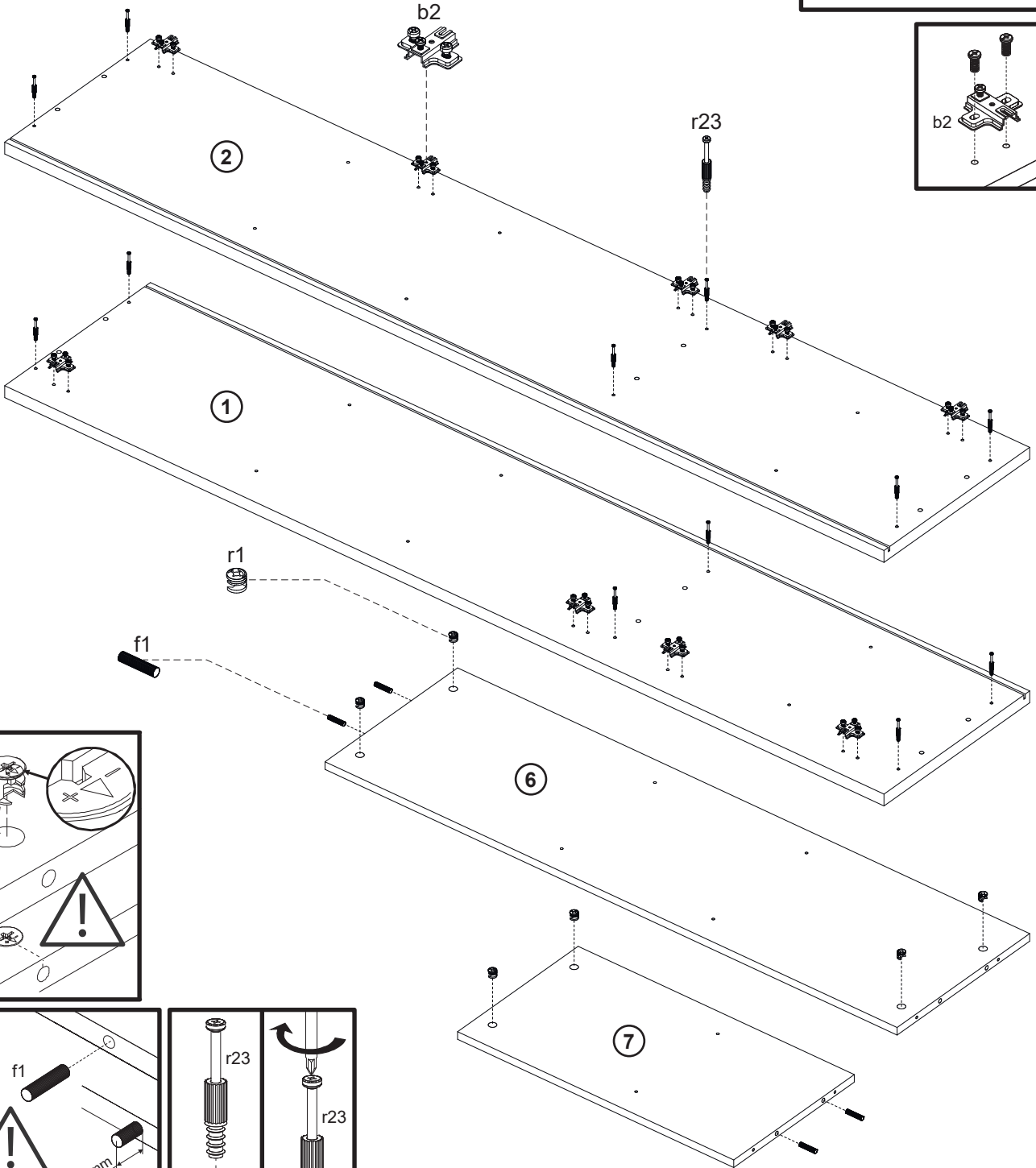
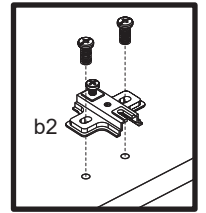
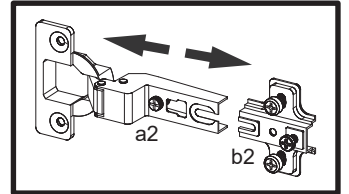

2

f1 x 12



Ø 8x30mm

r1 x 12



Ø 15x12mm

r23 x 2



45mm

p50 x 2



Ø 3x16mm

n14/2 x 1

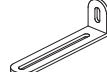

L=75x25x15mm

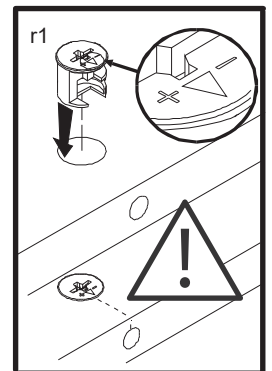
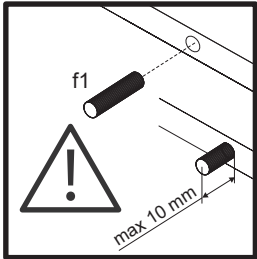
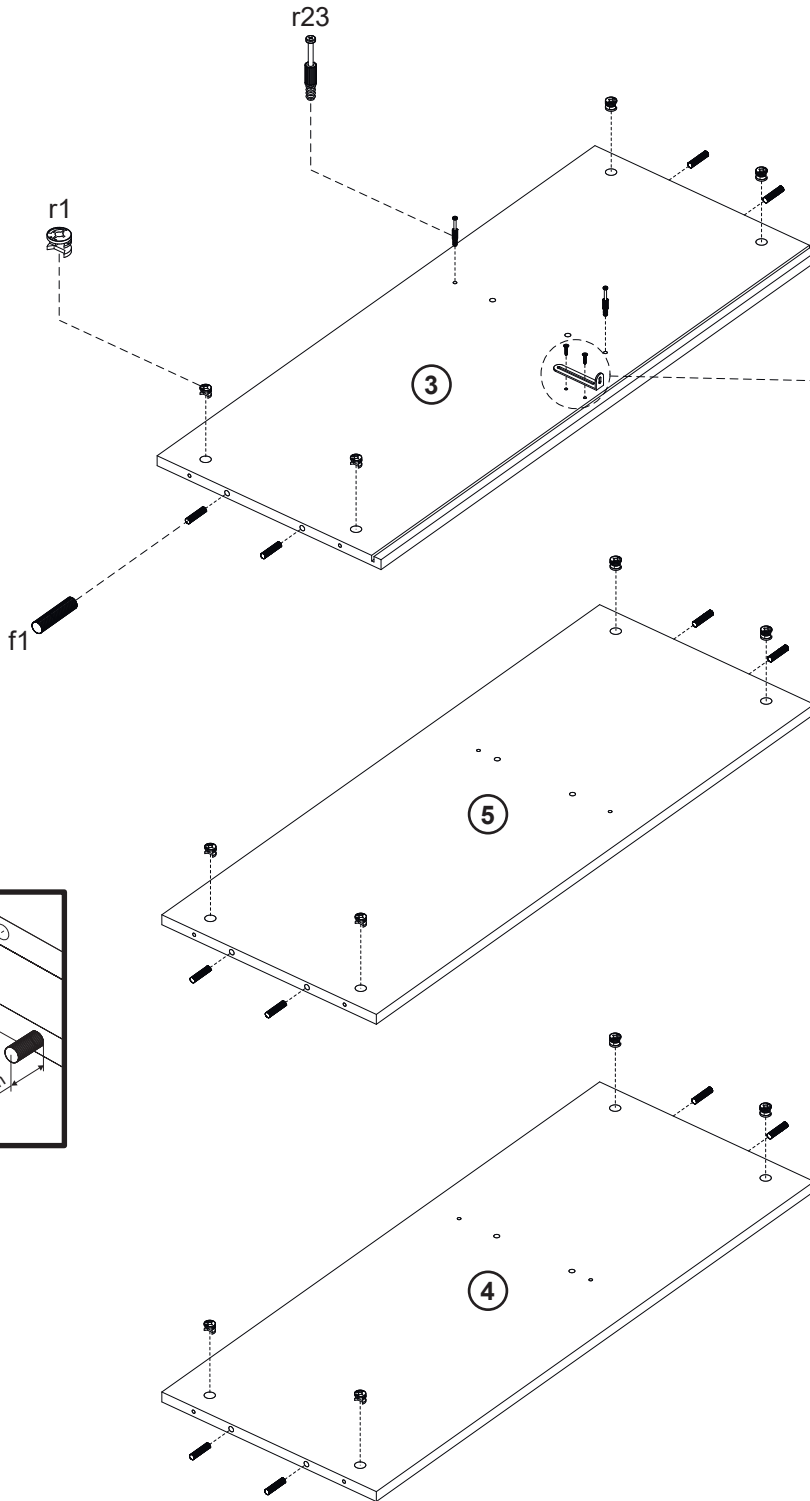
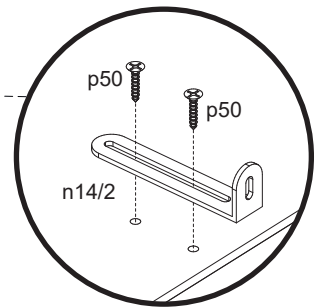
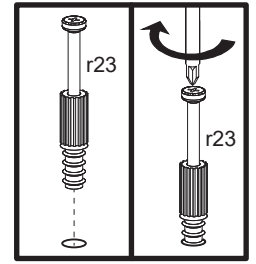

3

s1 x 2



Ø 20mm

f2 x 2







Ø 8x50mm

r24 x 2

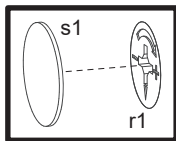
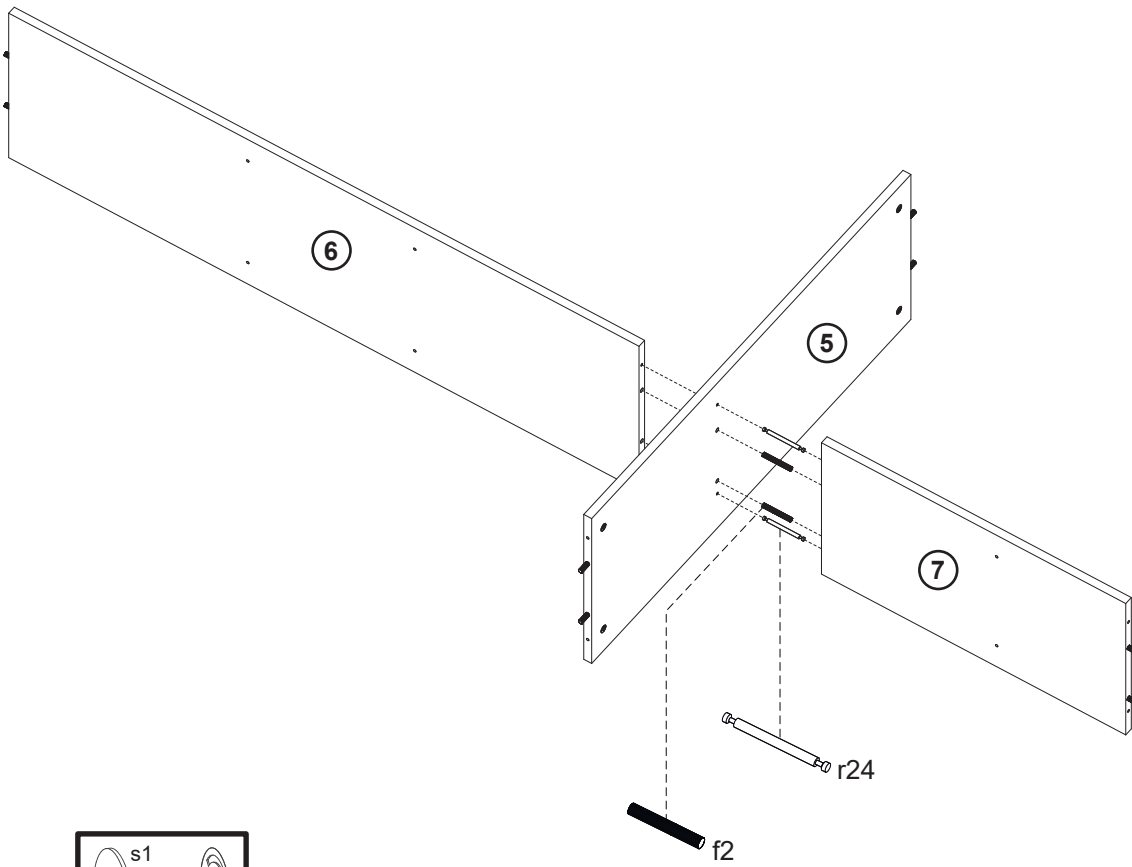
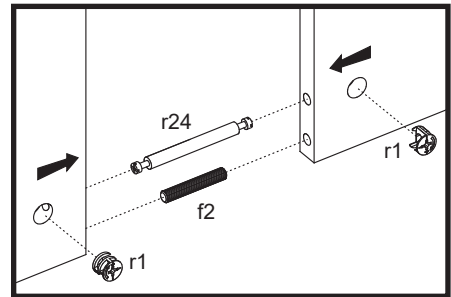





L=84mm

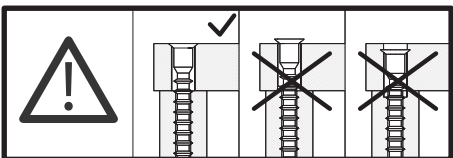
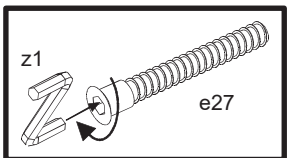
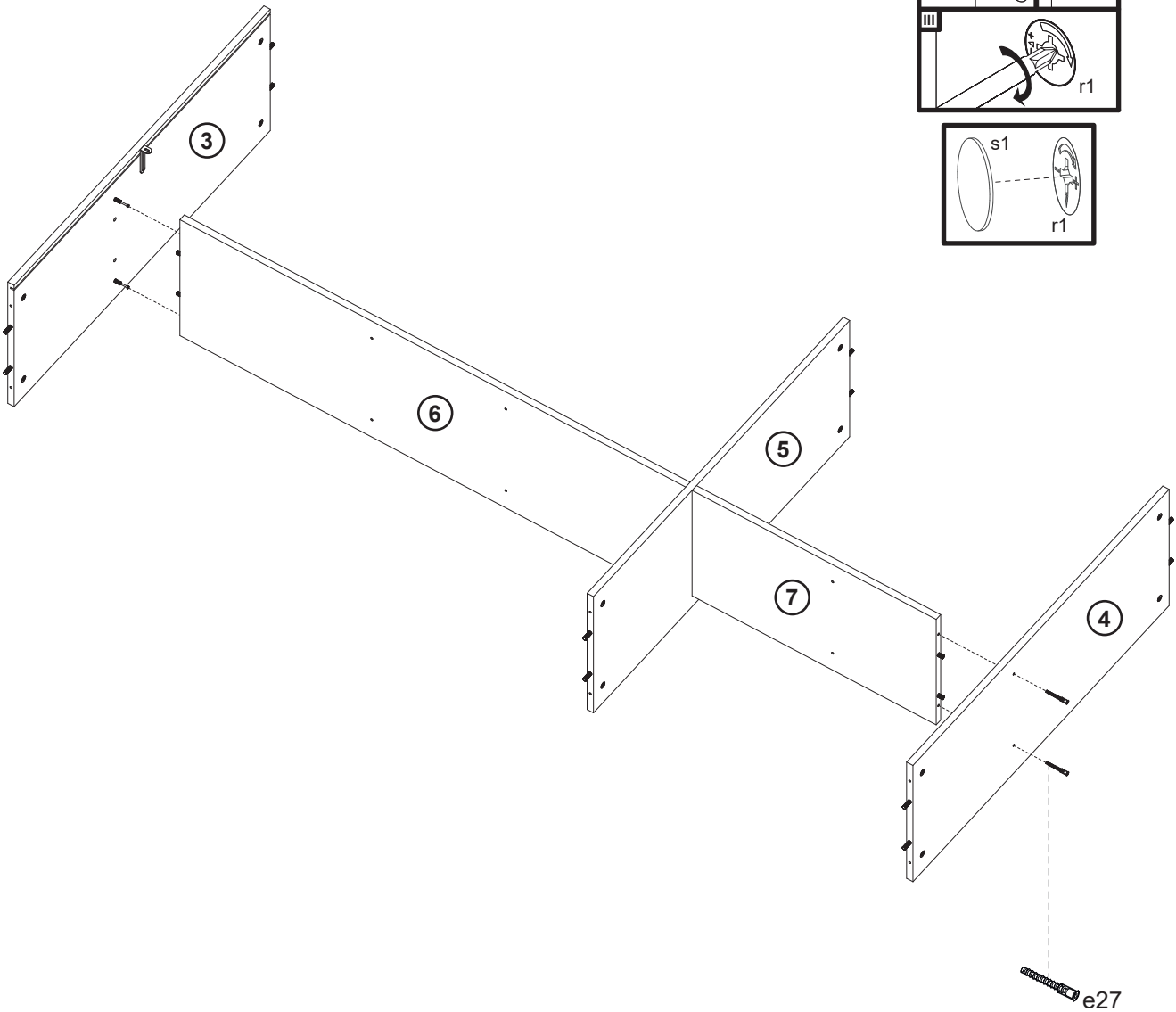



<h1>4</h1>	z1 x 1  4mm	e27 x 2  Ø 6,3x50mm	s1 x 2  Ø 20mm
------------	--	--	---

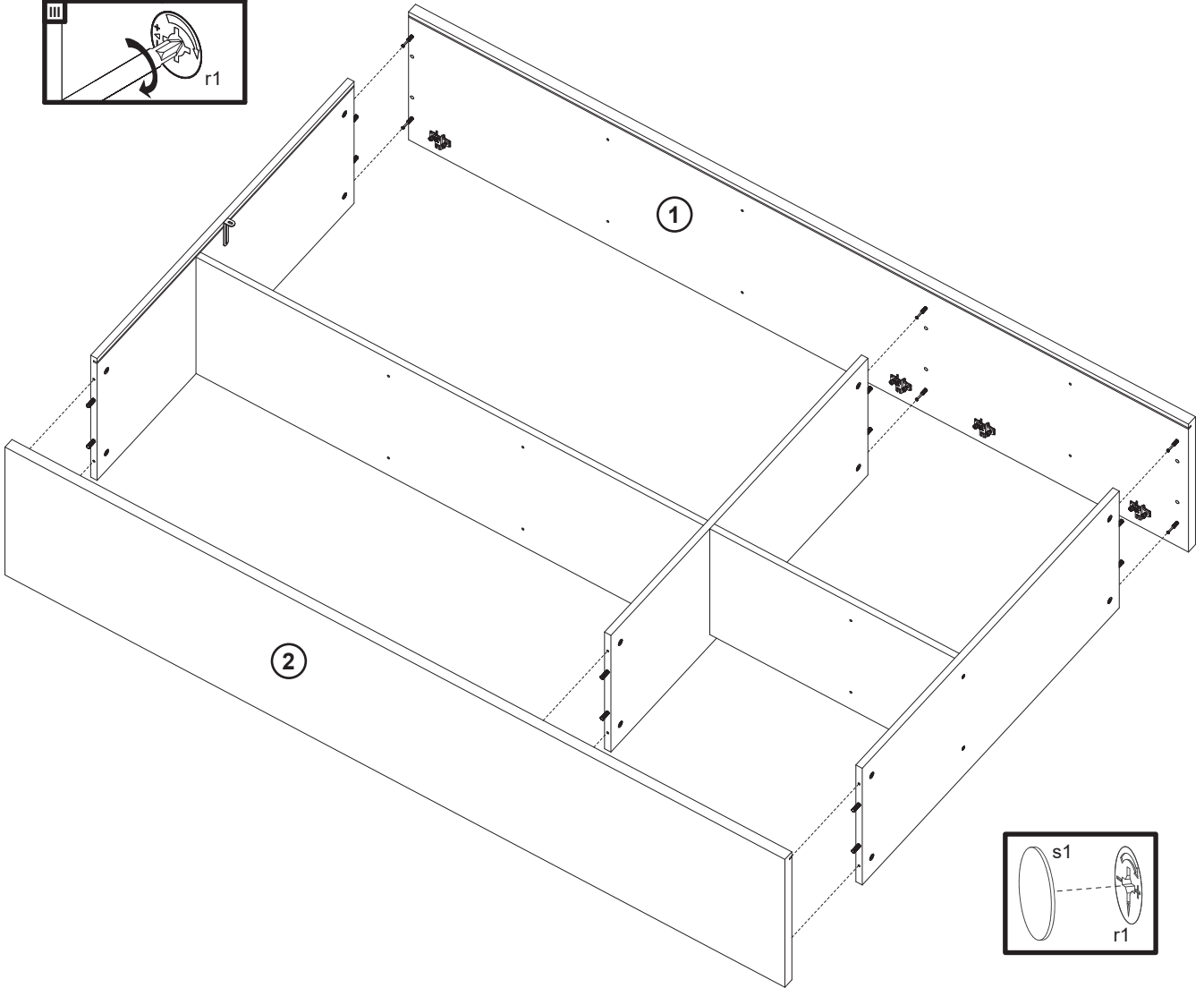

5	s1 x 4
	
	Ø 20mm

I 	II 
III 	



	s1
	r1

6

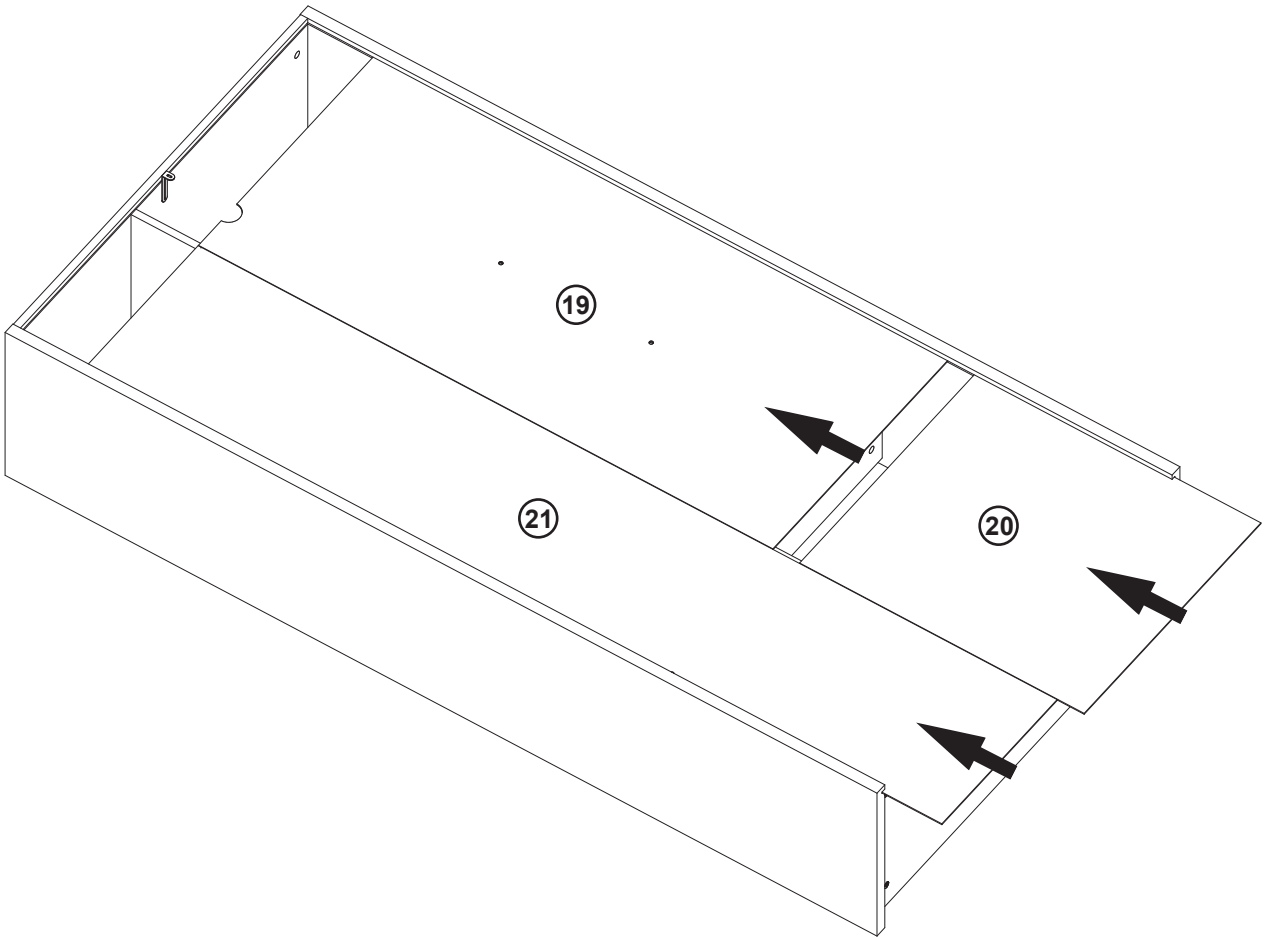

7

p21 x 4



Ø 4,2x16mm

l2 x 15



10x10x15mm

k40 x 4



Ø 15mm

k43 x 1



25x45x45mm

p25 x 1



Ø 4,2x25mm

n108 x 10

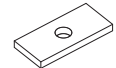

L=20x10x2mm

p50 x 10



Ø 3x16mm

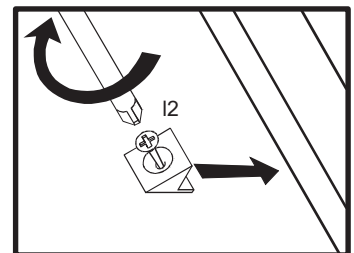
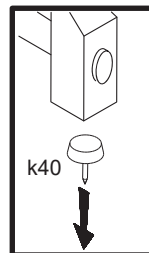
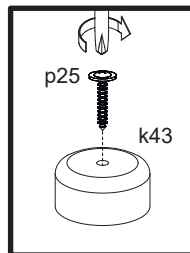
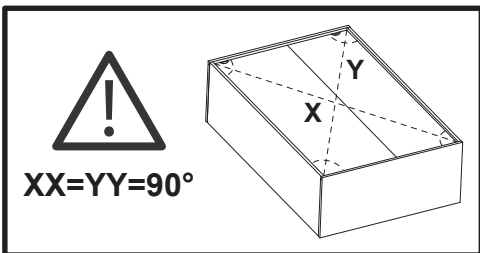
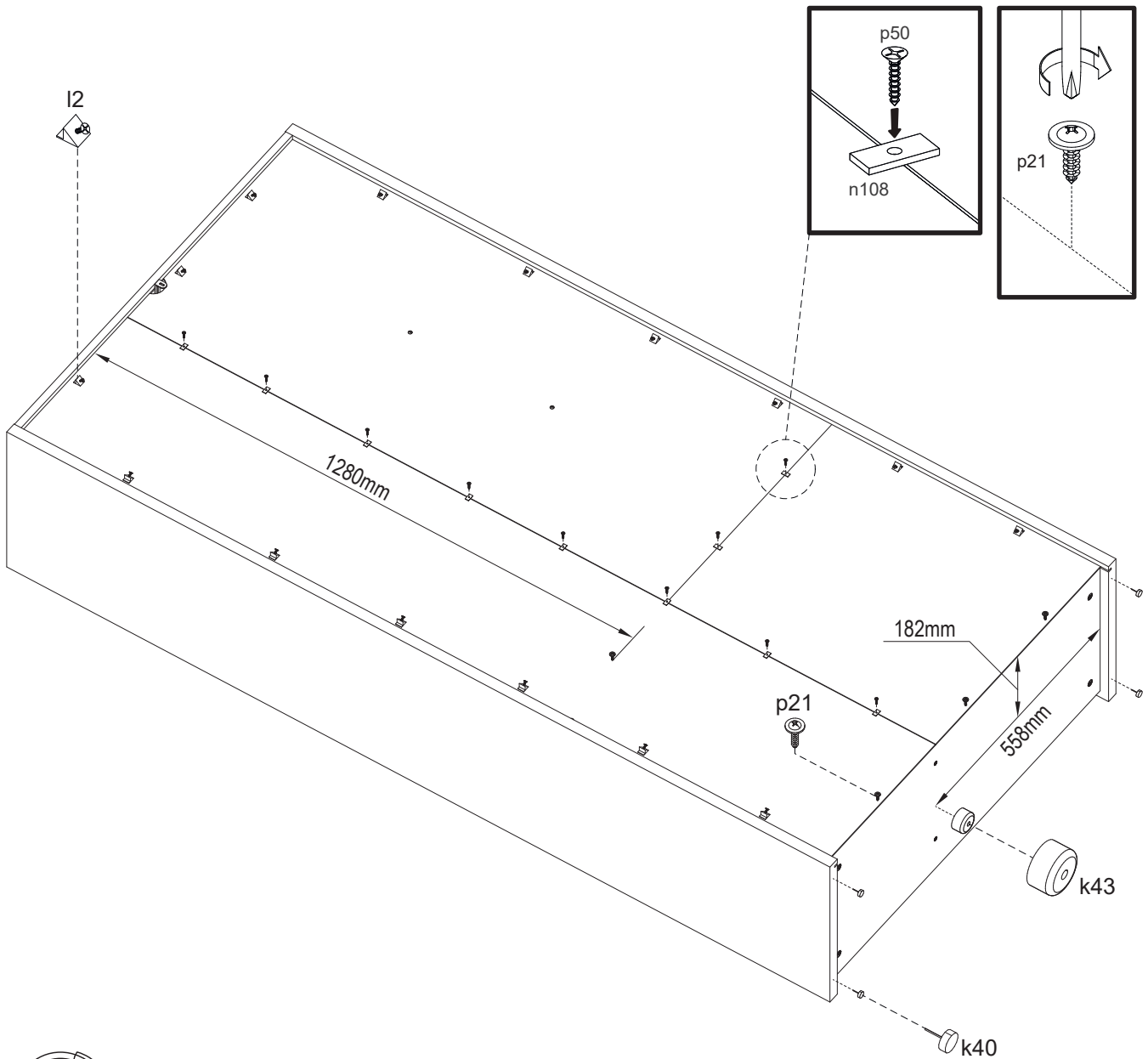

8

x4/1 x 1

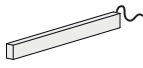

L=920mm

x4/2 x 1

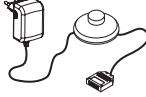

d8 x 2



Ø 8mm

d1 x 24



Ø 5mm

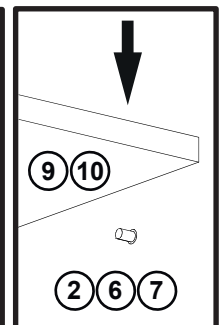
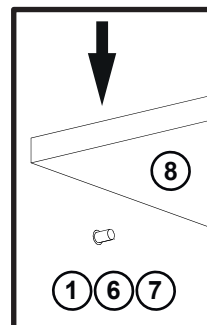
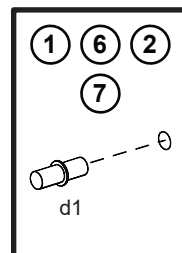
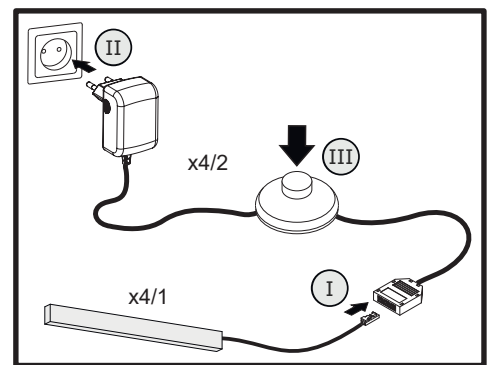
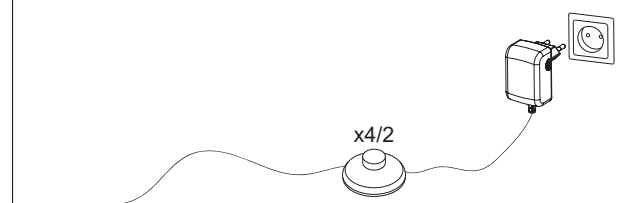
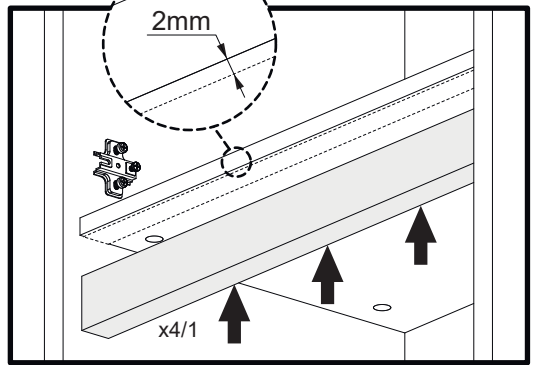
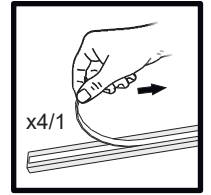
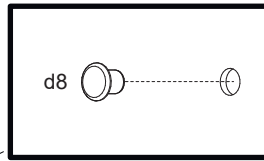
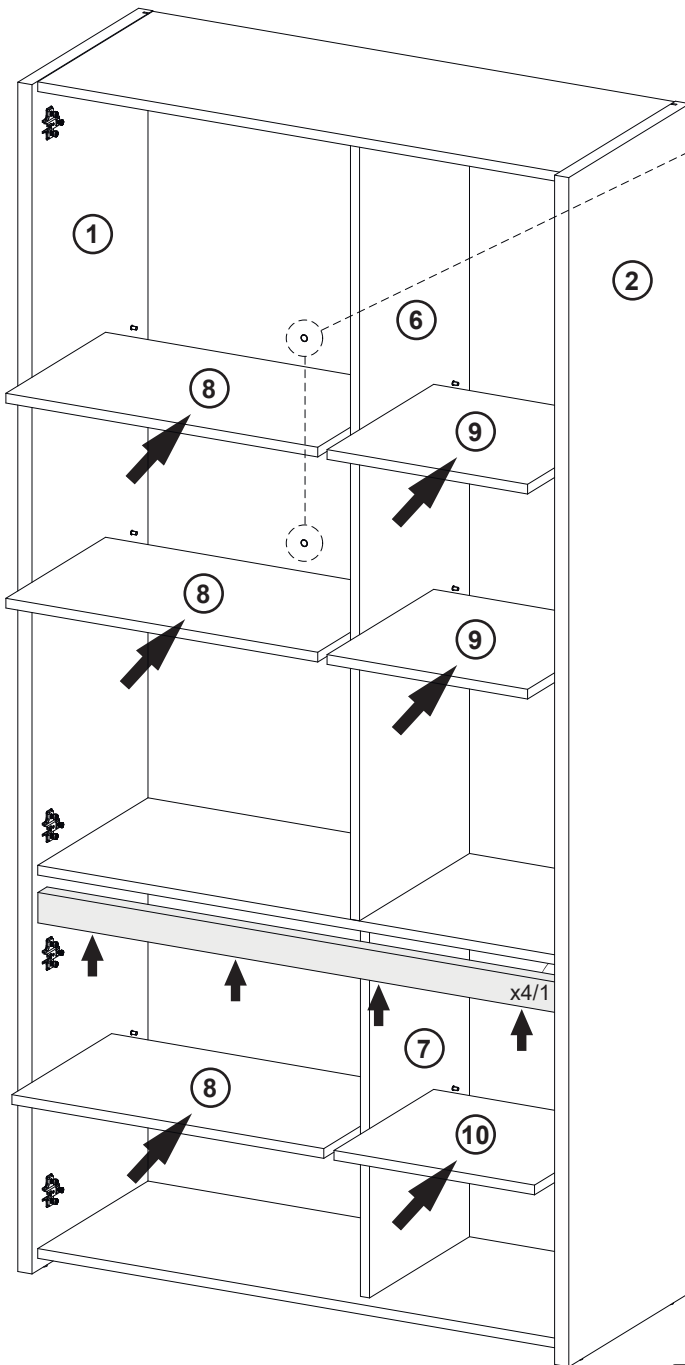

9

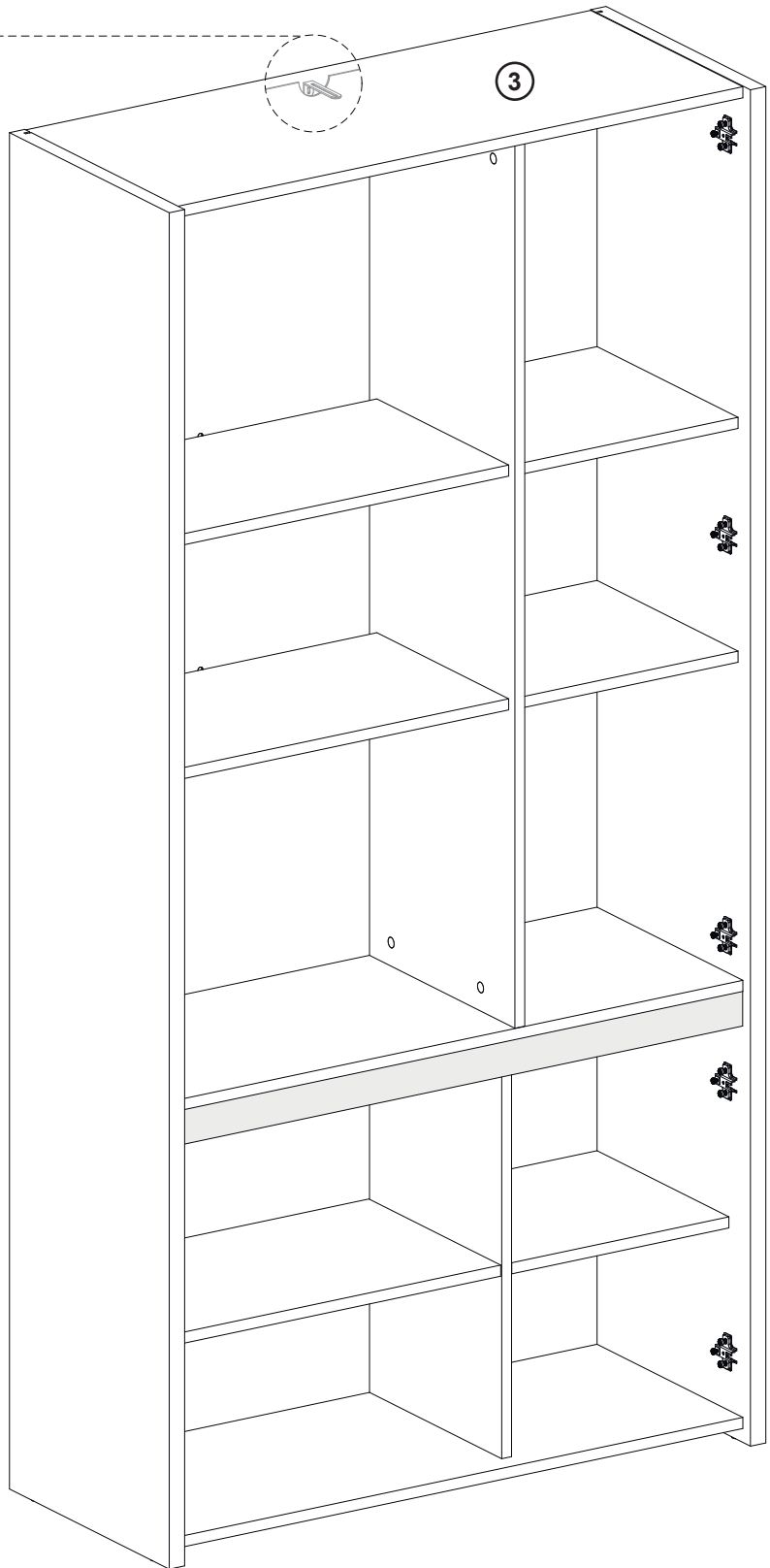
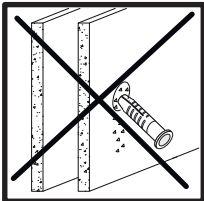
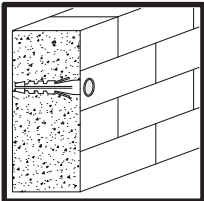
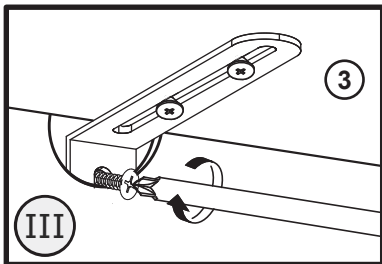
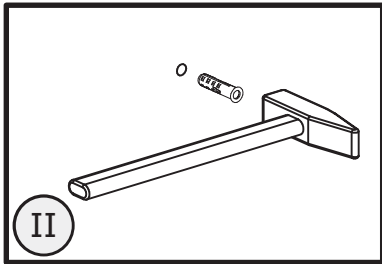
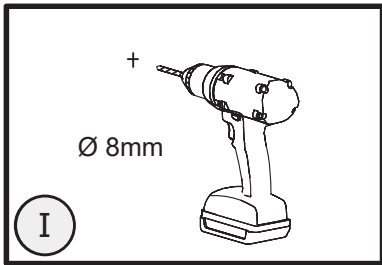
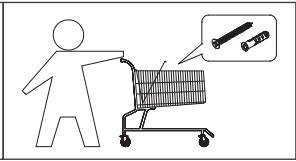

10

p51 x 10



Ø 3,5x16mm

a2 x 5

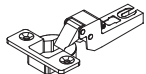

Ø 35mm

r5 x 3



Ø 6mm

r1 x 8



Ø 15x12mm

f3 x 4



Ø 8x40mm

r24 x 4



L=84mm

s7 x 8



Ø 20mm

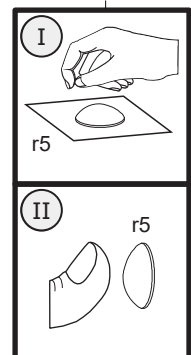
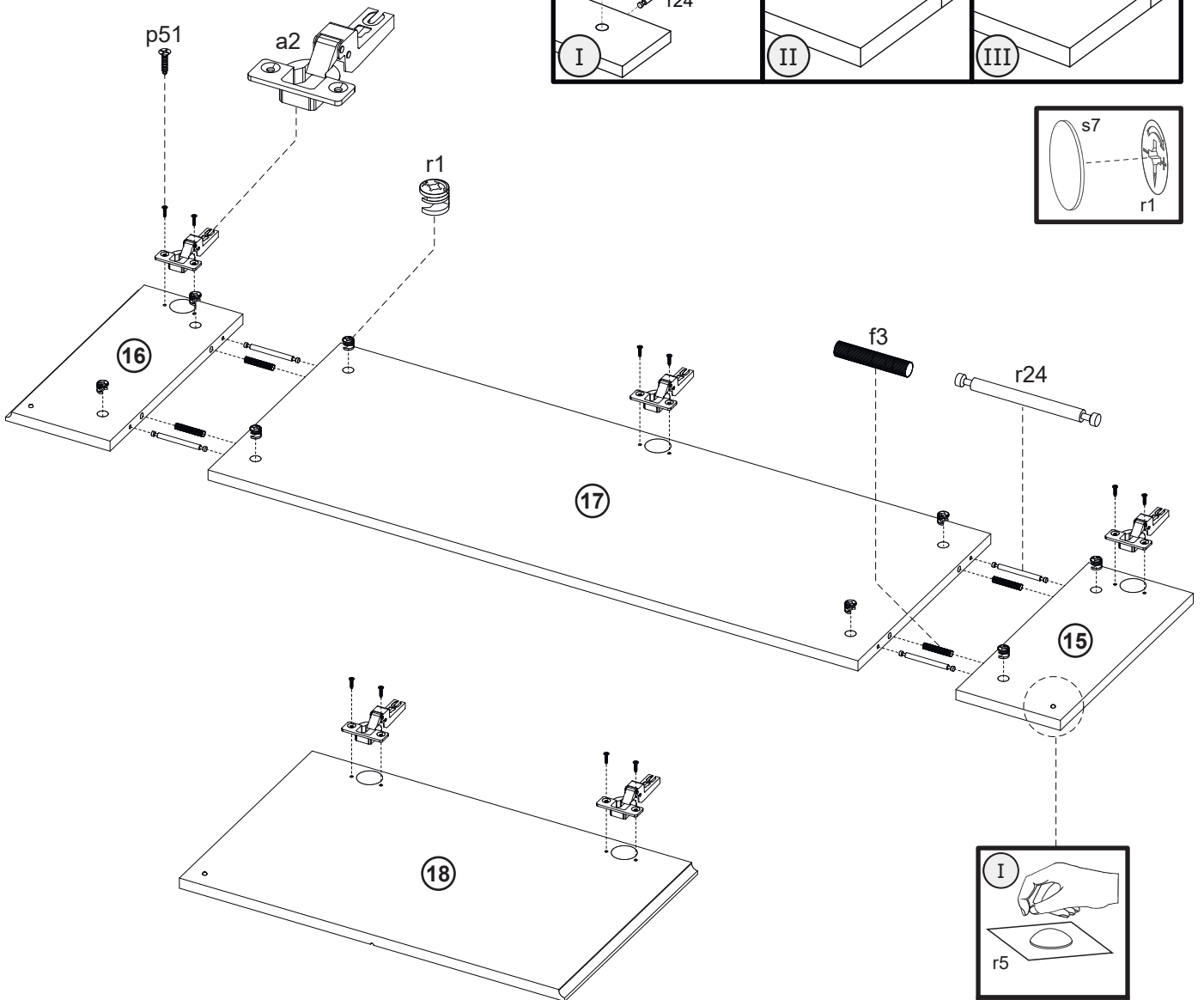
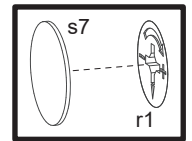
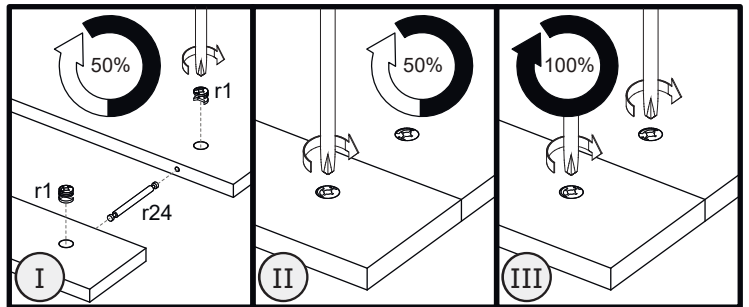

11

d6 x 6



10x6x10mm

p21 x 6



Ø 4,2x16mm

p51 x 8



Ø 3,5x16mm

a2 x 4

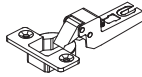

Ø 35mm

r5 x 3



Ø 6mm

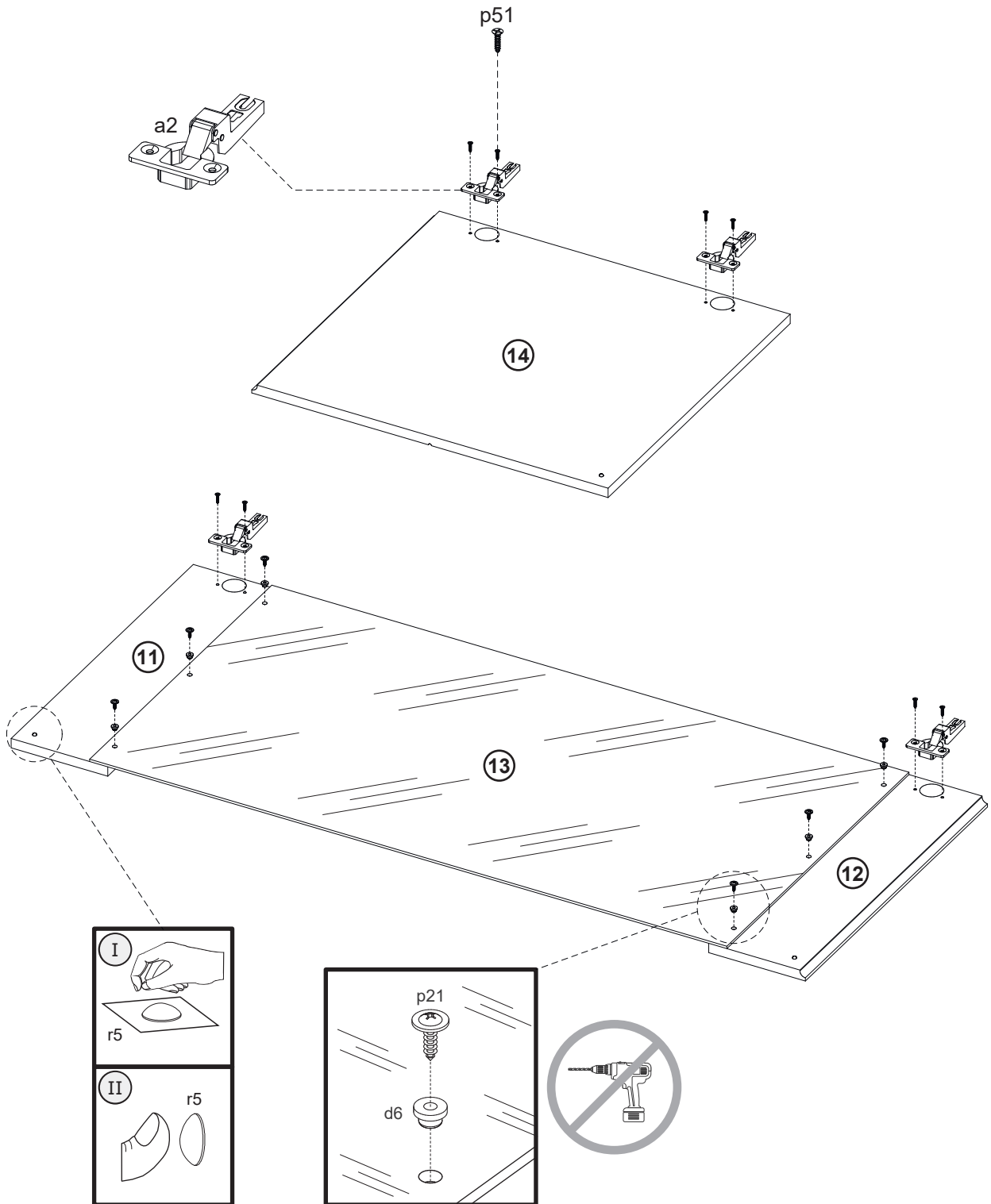

12

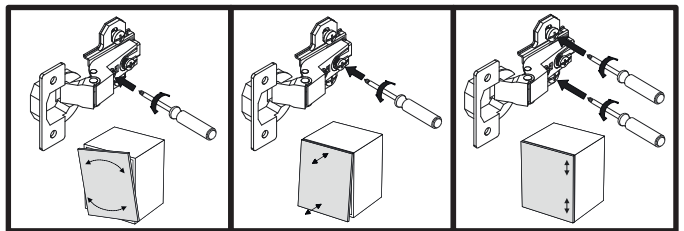
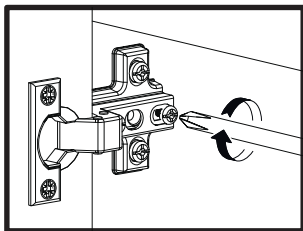
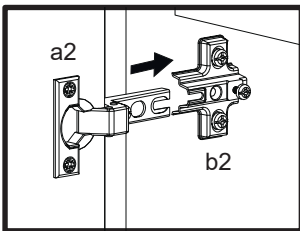
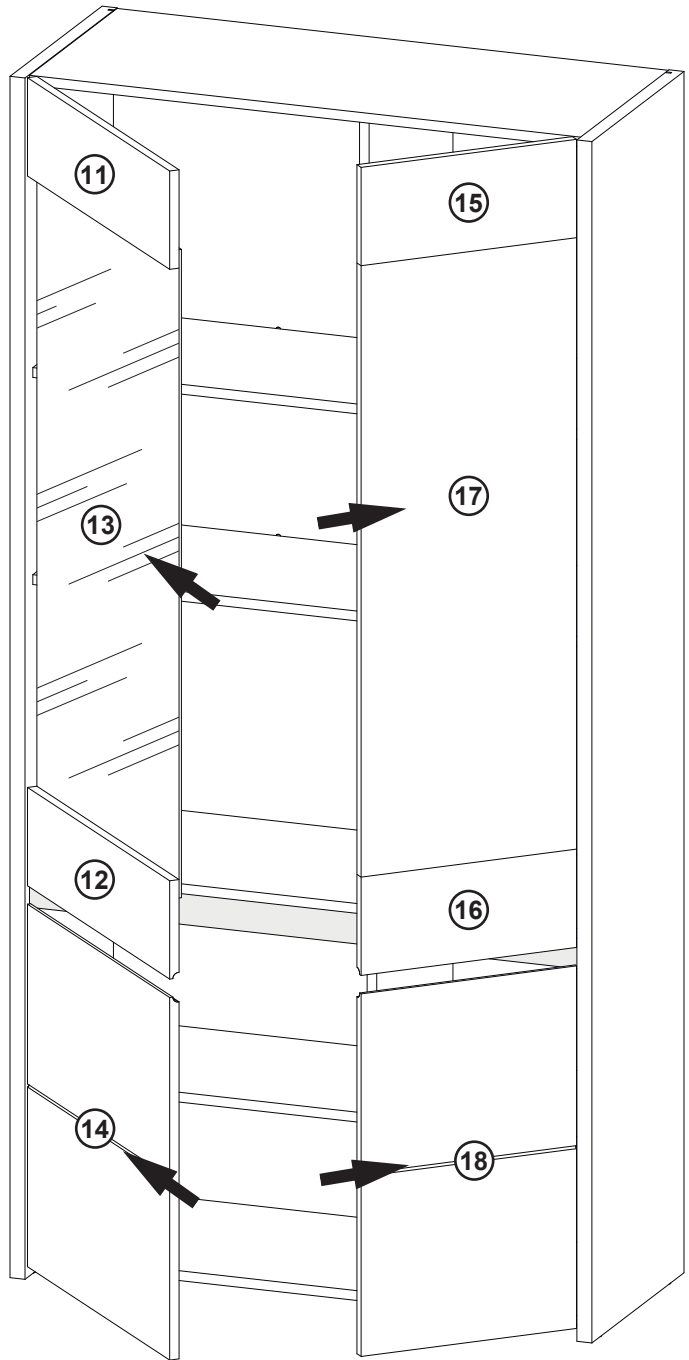

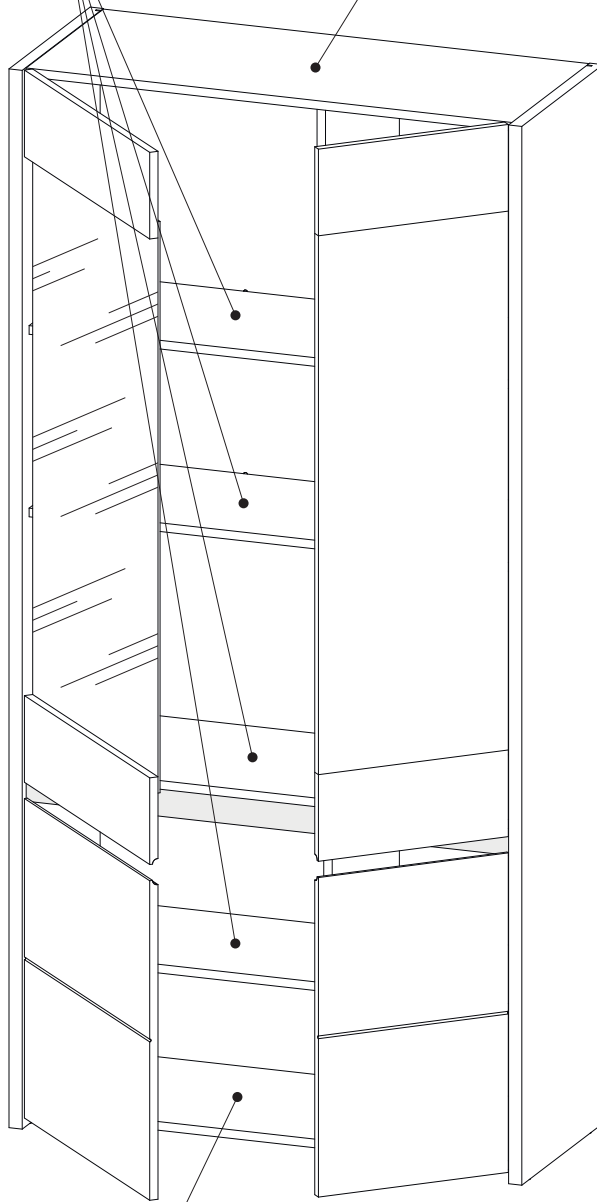

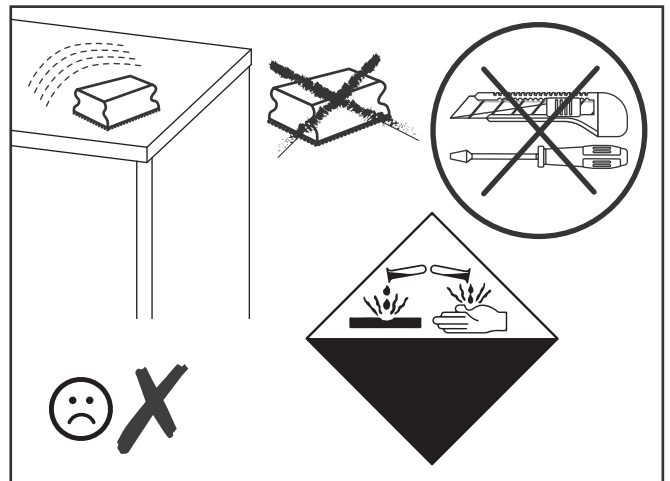
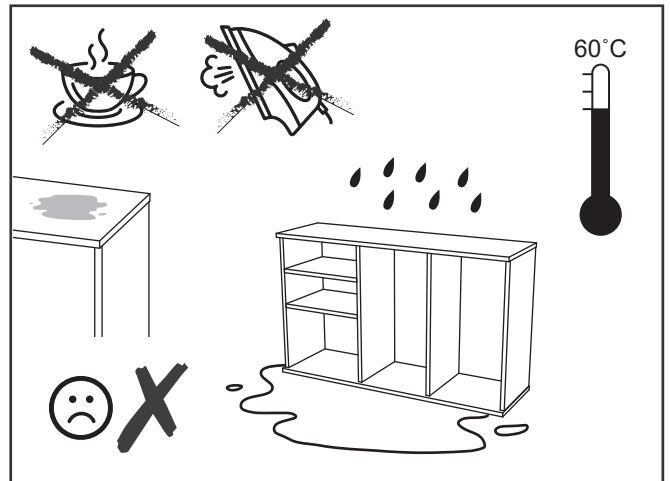
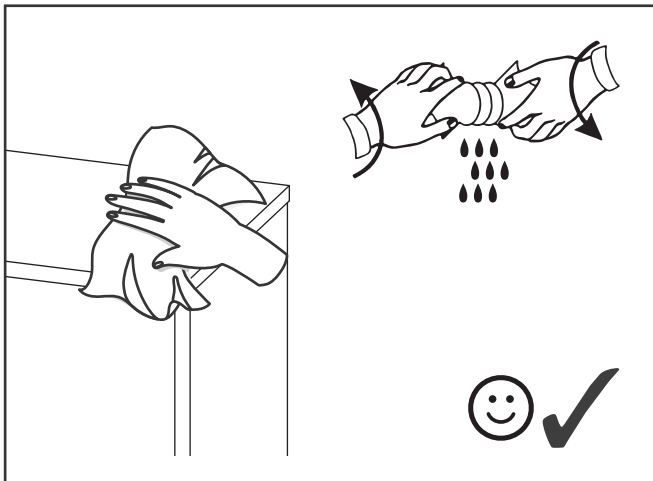
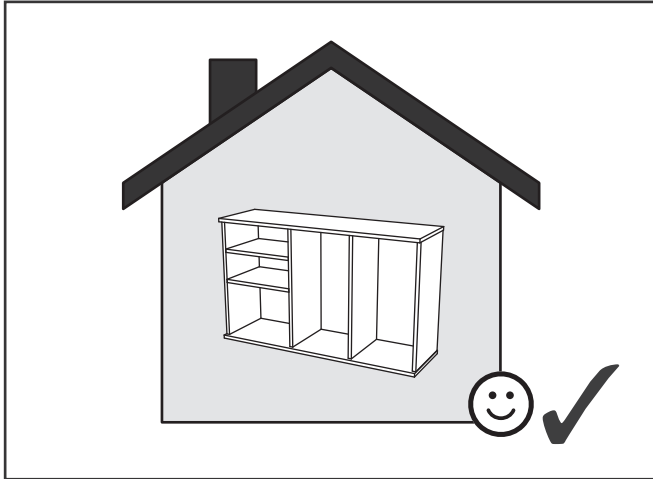

- PL** Powierzchnię mebli należy czyścić tylko środkami do pielęgnacji mebli. Szanowny kliencie w przypadku reklamacji prosimy wypełnić druki reklamacyjne dostępne w punktach sprzedaży przedkładając Kartę Reklamacyjną (zawierającą datę produkcji i numer pakowacza lub zmiany pakowania) umieszczona w każdej z paczek, oraz instrukcję montażu mebla, gdzie prosimy o zaznaczenie uszkodzonego elementu.
- SK** Povrch nábytku čistite iba prostriedkami určenými na ošetrovanie nábytku.Vá ení zákazníci! V prípade reklamácie prosíme, aby ste vyplnili tlačivá, ktoré sú prístupné v obchodoch, predlo ili Reklamačný list (ktorý obsahuje dátum výroby a číslo baliča alebo číslo zmeny pri balení), ktorý sa nachádza v ka dom balení a návod na montáž nábytku, v ktorom označte poškodenú čas.
- CZ** Povrch nábytku čistěte pouze přípravy určenými k ošetřování nábytku.Vá ený zákazníkú, v případě uplatnění reklamacie vyplňte prosím reklamační formuláře, které jsou dostupné v prodejnách a předlo te Reklamační kartu (obsahující datum výroby a číslo balení nebo změny balení, která je umístěna v balíčku) a návod k obsluze s vyznačením poškozeného dílu.
- BG** Повърхността на мебелите трябва да се почиства само с препарати за поддържане на мебели.Уважаеми клиенти, в случай на рекламация моля попълнете формулярите за рекламация, които ще получите в търговските пунктове, като представите Картата за рекламация (съдържаща датата на производство и номера на опаковчика или смяната за опаковане), която ще намерите във всяка опаковка, и инструкцията за монтаж на мебела, върху която да отбележите повредения елемент.
- RO** Suprafata ei trebuie să fie curătată numai cu substanțe destinate pentru curățarea mobilei.Stimate Cumpărător, în caz de reclamatie vă rugăm să completați formularul de reclamatie pe care îl puteți lua de la punctul de vânzare și pe care îl veți prezenta împreună cu Cartela de Garantie (care conține data producției și nr ambalatorului sau turei de ambalare), însoțită la fiecare ambalaj, precum și instrucțiunile de montaj ale mobilei, pe care vă rugăm să marcați elementul deteriorat.
- UA** Поверхню меблів потрібно чистити тільки засобами для догляду за меблями.Шановний клієнте для заяви рекламачії, просимо заповнити формуляр рекламачії, доступний у пунктах продажу, вказуючи рекламачійну карту (містить дату виробництва та номер пакувальника або зміни упаковки), прикладену до кожного пакету, а також інструкцію з монтажу меблів, на якій просимо позначити пошкоджений елемент.
- RUS** Поверхность мебели надо чистить только средствами для ухода за мебелью.Уважаемый клиент для заявления рекламации, просим заполнить формуляр рекламации, доступный в пунктах продажи, указывая Рекламационную карту (содержащую дату производства и номер упаковщика или смены упаковки), приложенную к каждому пакету, а также инструкцию по монтажу мебели, на которой просим обозначить поврежденный элемент.
- DE** Reinigen Sie den Möbelbereich nur mit Möbelpflege. Kunden, bei Beanstandung Bitte füllen Sie die Reklamationsformulare, die in den Verkaufsabteilungen erhältlich sind, vor dem Verkauf aus eine Reklamationskarte (mit Angabe des Produktionsdatums und der Anzahl der Personen, die die Waren verpacken, oder der Anzahl der Schichten)Verpackung), die in jeder Packung enthlten ist, und Halterungen, in denen Sie reichlich vorhanden oder beschädigt sind ElementeReinigen Sie den Möbelbereich nur mit Möbelpflege. Kunden, bei Beanstandung.
- GB** Furniture surface must be cleaned only with furniture maintenance formulas.Dear Customer, should you wish to file a complaint, we would request you to fill in the complaint forms available in our outlets, submitting the Complaint Card (specifying the date manufactured, packaging employee/ shift code) enclosed in each of the packets, together with the Assembly Manual, where please highlight the faulty component.
- H** A bútorok felületét kizárólag a bútorápolószerekkel lehet tisztítani. Tisztelt Vásárló! Reklamáció esetén kérjük az eladási helyeken kapható reklamációs nyomtatványokat kitölteni a Reklamációs Lap (tartalmazza a gyártási dátumát és csomagoló számát vagy műszakszámát) bemutatásával, amely mindegyik csomagban található, valamint a bútor szerelési utasítását, amelyen kérjük a sérült elemet bejelölni sziveskedjék.
- FR** La surface des meubles ne peut être nettoyée qu'avec des produits pour l'entretien de meubles. Cher Client, en cas de réclamation, veuillez bien remplir des formulaires de réclamation accessibles dans les centres de vente en montrant le mode d'emploi pour monter le meuble. Nous vous demandons de bien vouloir y entourer l'élément en panne.
- ES** Limpiar la superficie de muebles exclusivamente con los agentes para el cuidado de los muebles.Estimado Cliente, en caso de reclamaciones, hagan favor de rellenar los formularios de reclamación disponibles en los puntos de venta, presentando las instrucciones de montaje de mueble, donde es necesario indicar un elemento estropeado.
- NL** Het oppervlak van meubels hoeft alleen te worden gereinigd door middel van meubelverzorging Beste klant voor de verklaring!
klacht, vul dan het klachtenformulier in dat beschikbaar is in de verkooppunten, met vermelding van: klachtenkaart (bevat de fabricagedatum en het nummer van de verpakker of verandering van verpakking), bevestigd aan elk pakket, evenals instructies voor het installeren van meubels, die we u vragen te markeren beschadigd item.