

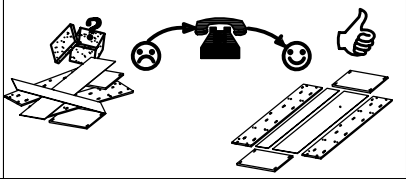

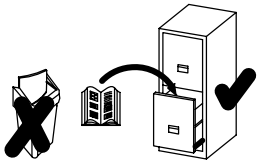

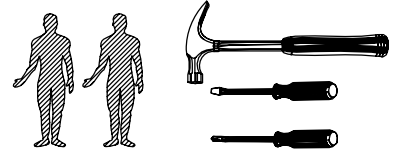







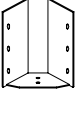
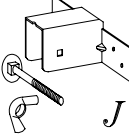

Verwood 51/52

Instrukcja montażu
Montageanleitung
Instructions D'assemblage
Assembly instructions



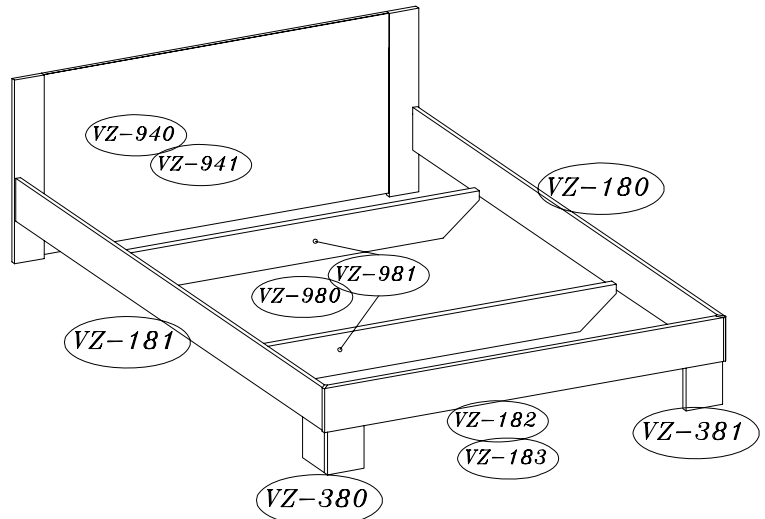

10X35  A	 B	6.3X13  C	6.3X13  D
2	4	12	4
4.0X16  E	 F	 H	
16	1	2	
 J	<p>51 -   </p> <p>52 -   </p>		
4			



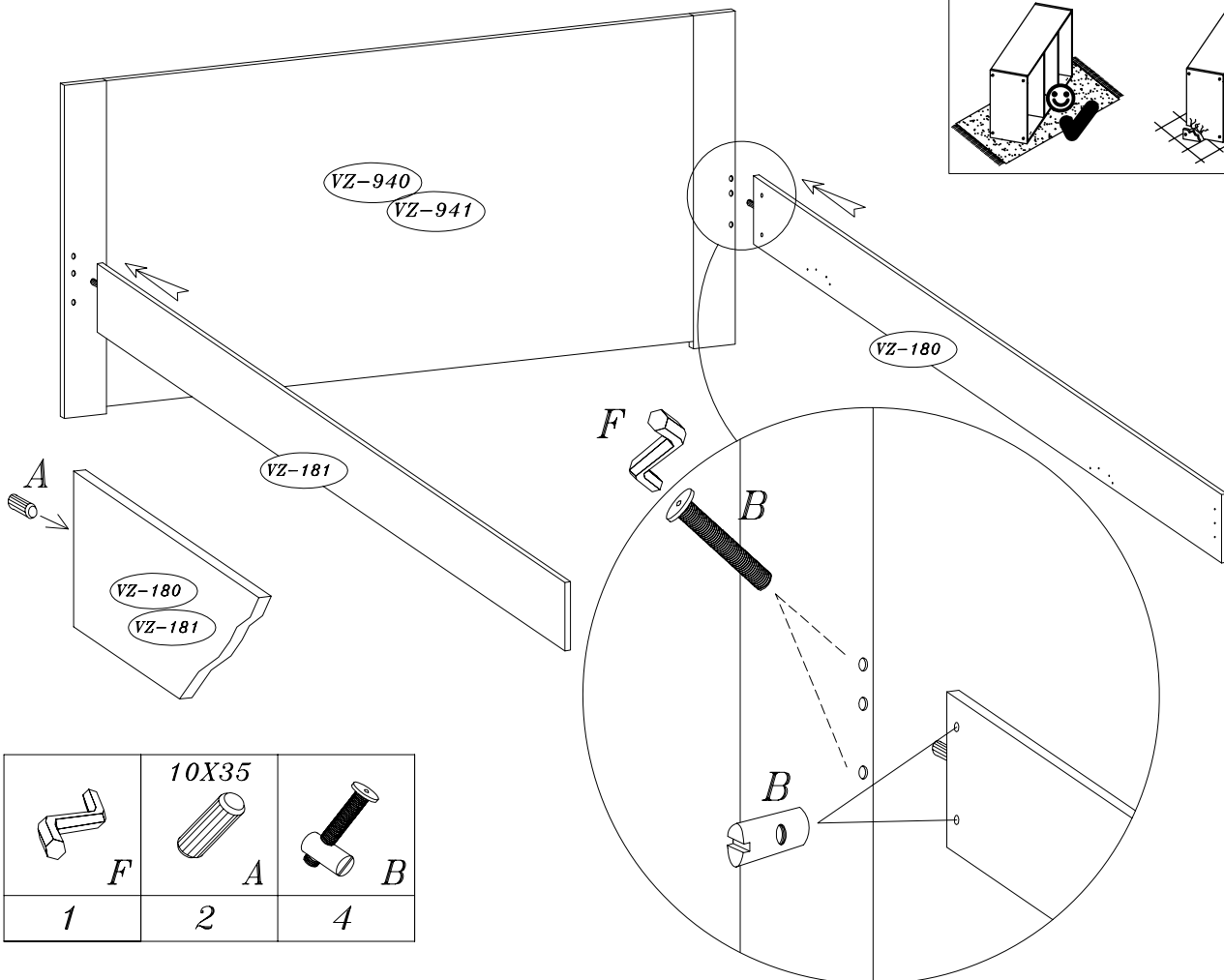

1



 F	10X35  A	 B
1	2	4

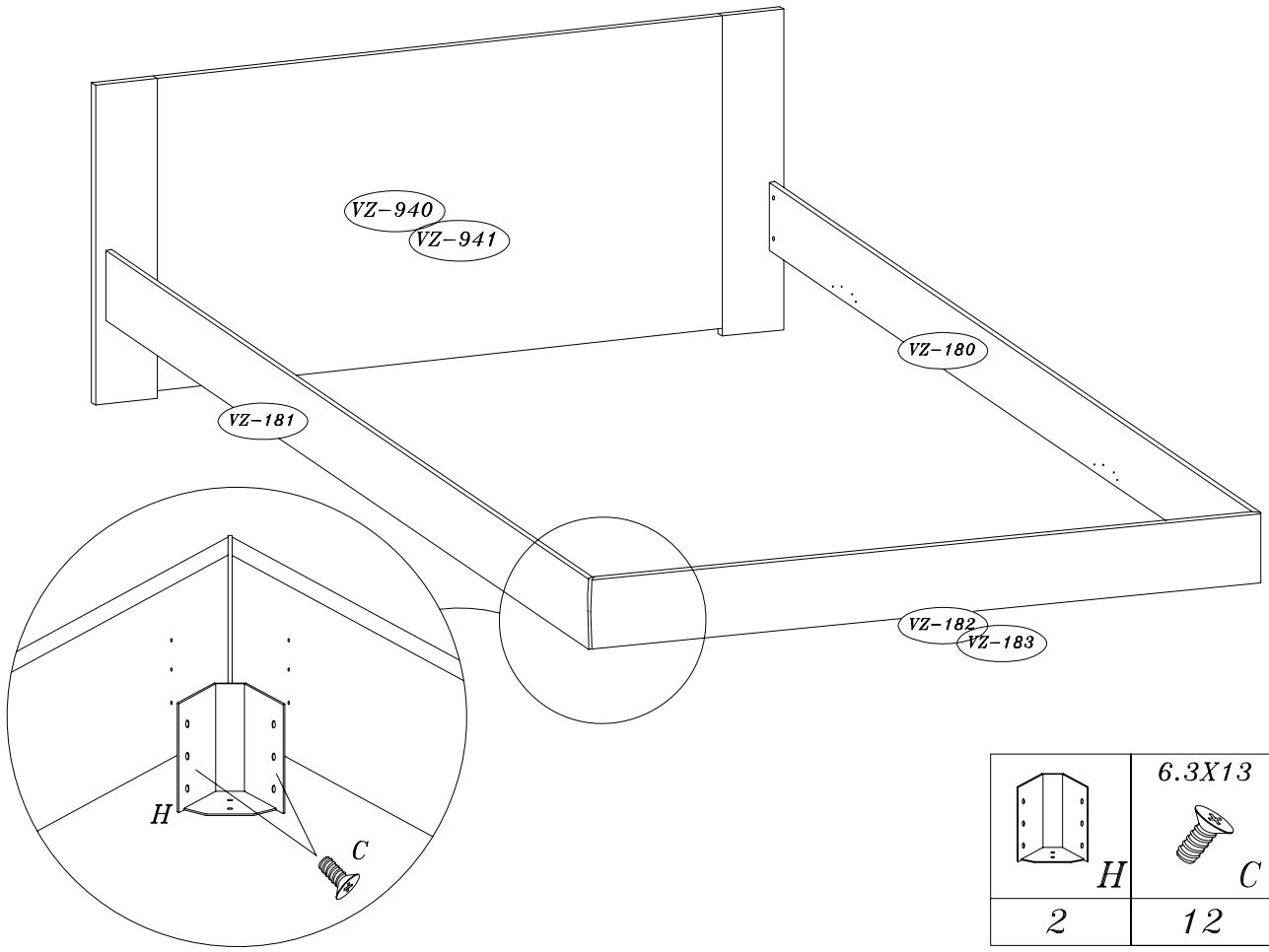

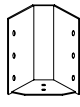
2



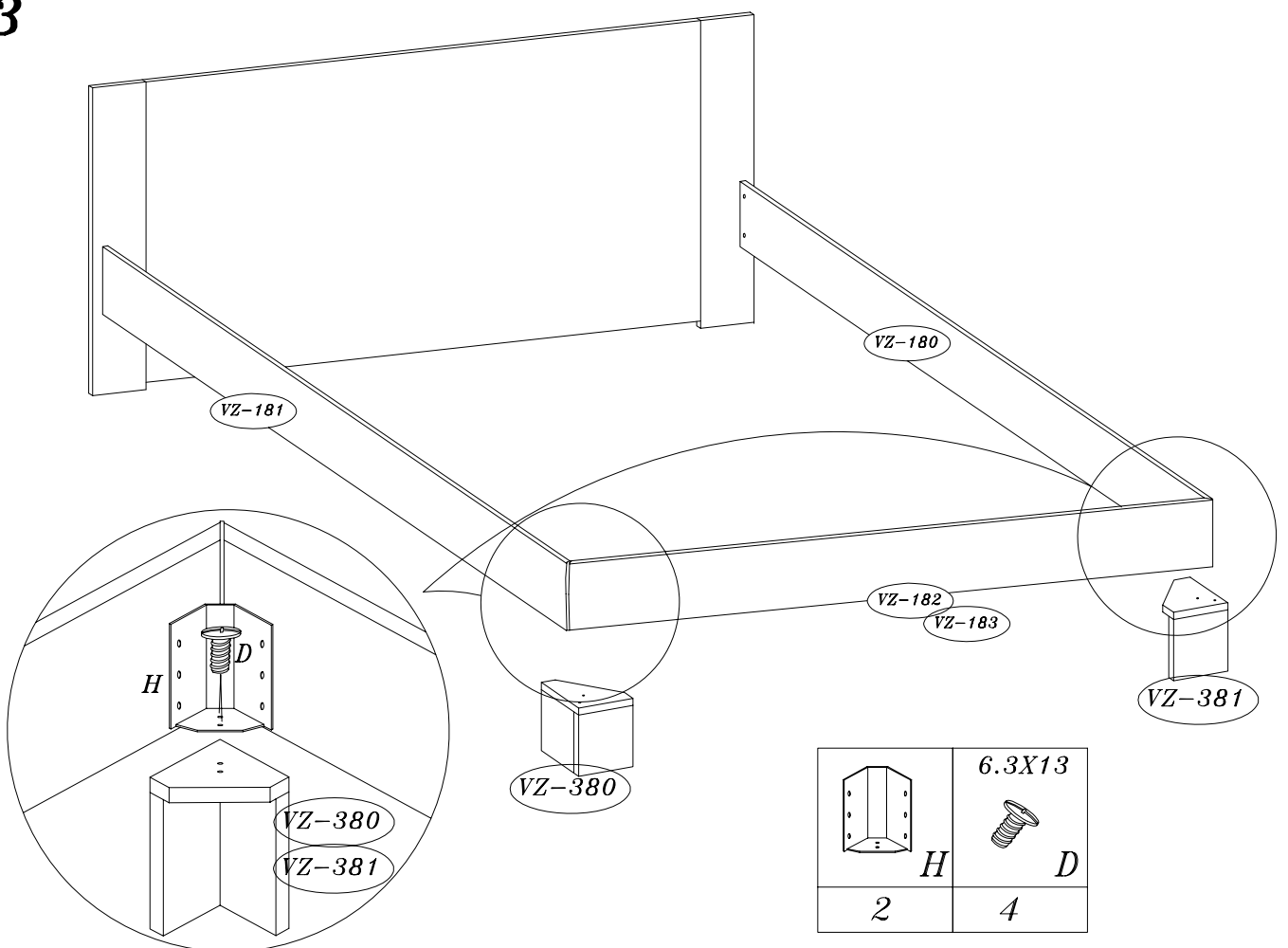

	6.3X13
	
H	C
2	12

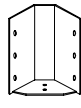
3

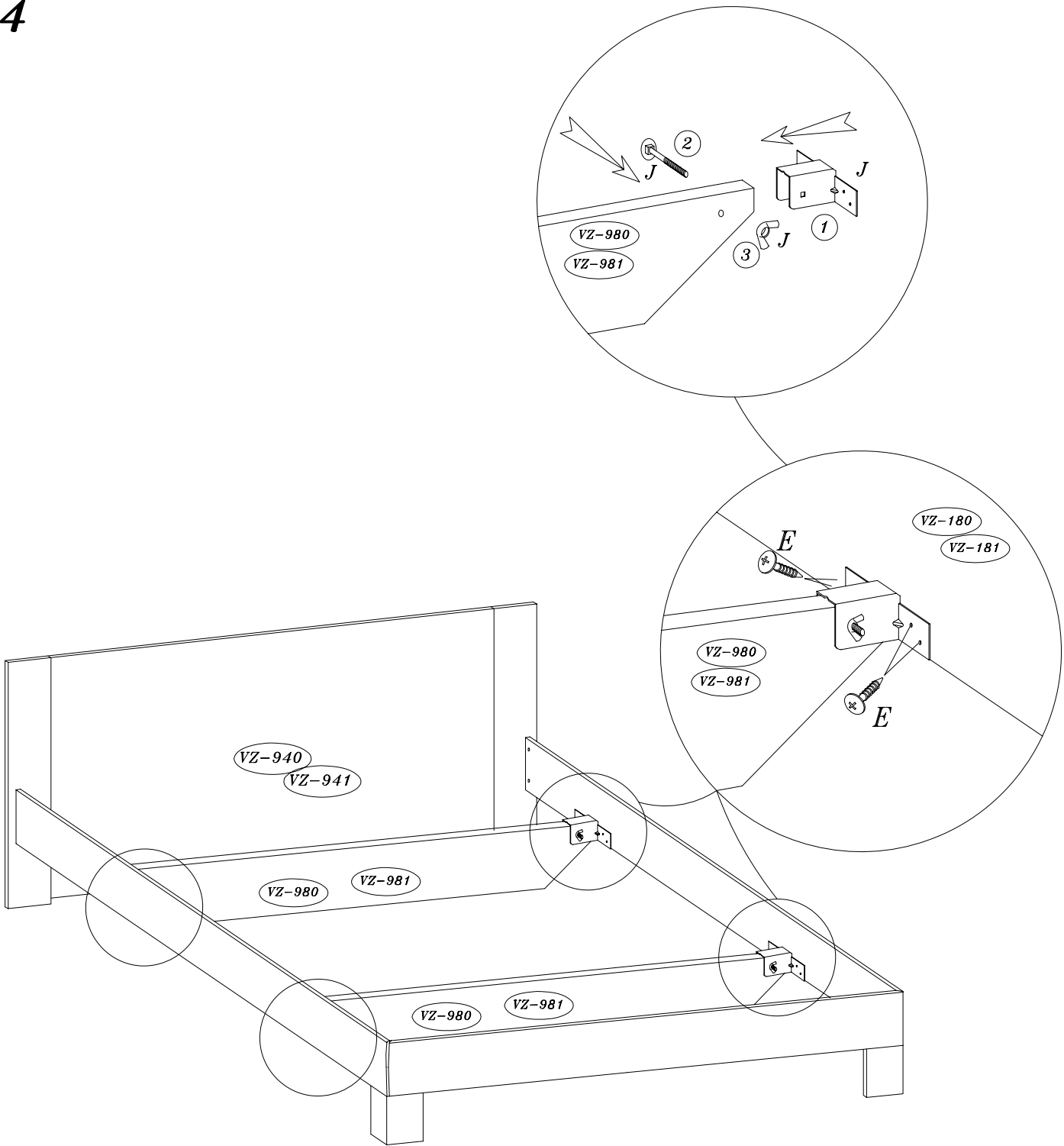

	6.3X13
	
H	D
2	4

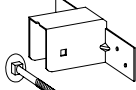

	4.0X16 
J	E
4	16

SERVICEKARTE

Artikel-Nr.:

...

Type: (falls vorhanden)







Farb-Nr.: (falls vorhanden)

Liebe Kundin, lieber Kunde,





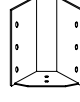
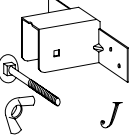

obwohl wir unsere Moebel vor der Auslieferung einer eingehenden Endkontrolle unterziehen, kann statt kenn es vorkommen, dass einmal ein Zubehoerteil fehlt oder dass ein Teil waehrend des Transportes beschaedigt wird. **Senden Sie den Artikel in so einem Fall bitte nicht zurueck**, sondern fordern Sie einfach Ersatz fuer das fehlende bzw. beschaedigte Teil bei unserer **Kunden - Hotline** an. Die Telefonnummer finden Sie auf den **Serviceseiten** im aktuellen Katalog.

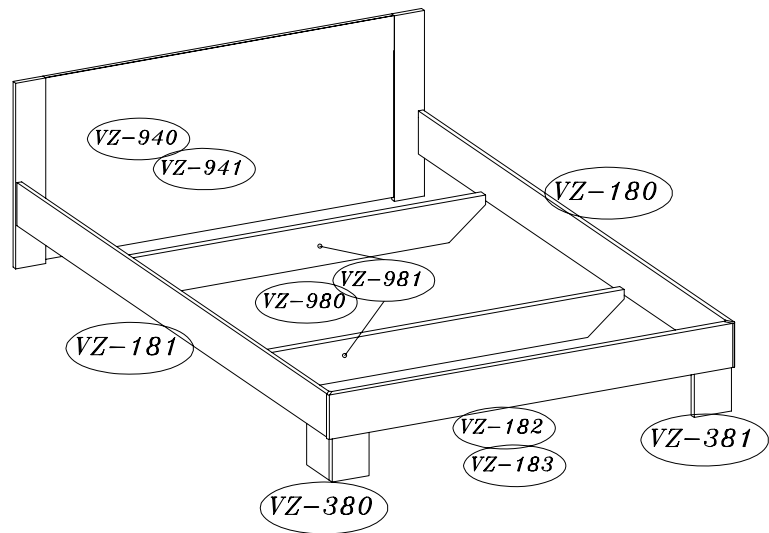
Bitte nennen Sie bei der Ersatzteilbestellung **Modellnamen, Artikelnummer, Type und Farbnummer** des Moebelsueckes sowie die benoetigten **Ersatzteilnummern /- bezeichnungen**, wie sie in dieser Anleitung angegeben sind.

Wir werden ihre Anforderung sofort bearbeiten und Ihnen das Ersatzteil umgehend zusenden.

<i>10X35</i>  A	 B	<i>6.3X13</i>  C	<i>6.3X13</i>  D
2	4	12	4
<i>4.0X16</i>  E	 F	 H	
16	1	2	
 J			
4			



- 51 -   
- 52 -   

Hier koennen Sie die Schrauben zur besseren Identifizierung nachmessen (alle Massangaben in mm).

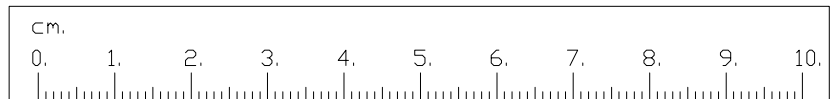

Bitte fuellen die anstatt dieses Servicekarte sorgfaeltig aus, damit Sie alle noetigen Daten bei Ihrer Ersatzteilbestellung zur Hand haben. Die Telefonnummer der Bestellannahme finden Sie in Ihrem aktuellen Katalog.

Modellname

Tel. fuer Ruckfragen:

Artikel - Nr.:

Grund der Ersatzteilanforderung:

Type

Benoetigte Teile:

Farb - Nr.:

Kundennummer:

Teile - Nr.	Bezeichnung	Anzahl

Name:

Strasse: Haus - Nr.:

PLZ Ort:

Rechnungsdatum: