

PRZED ROZPOCZĘCIEM MONTAŻU ZAPOZNAĆ SIĘ Z INSTRUKCJĄ

Narzędzia niezbędne do montażu (nie dostarczane przez producenta)

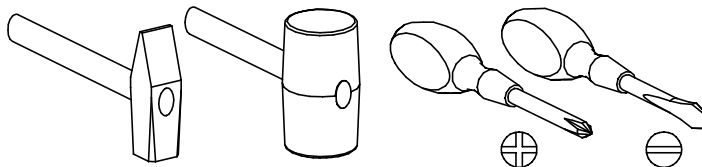

20

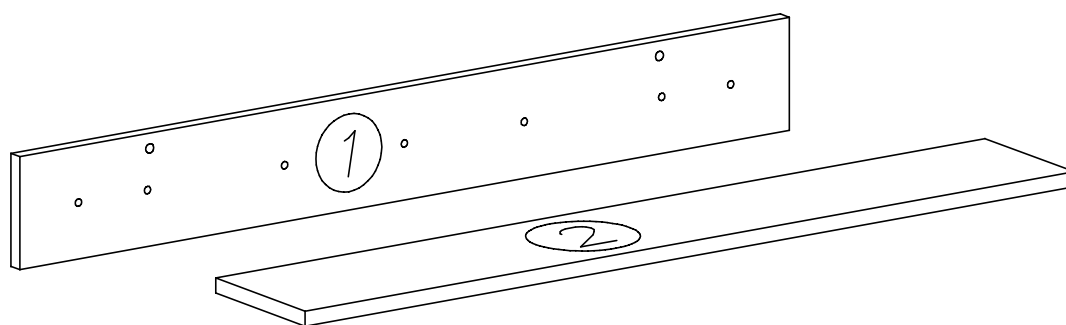
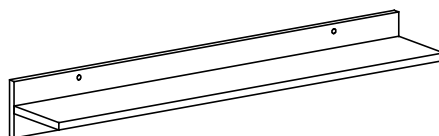

Nr	Nazwa elementu	Dł [mm]	Szer [mm]	Gr [mm]	Ilość
1	tył	963	120	16	1
2	półka	963	160	16	1

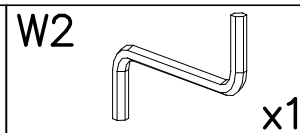
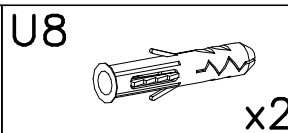
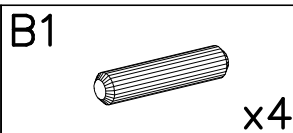
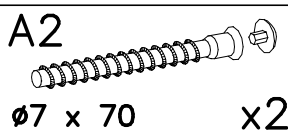
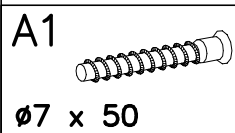

1

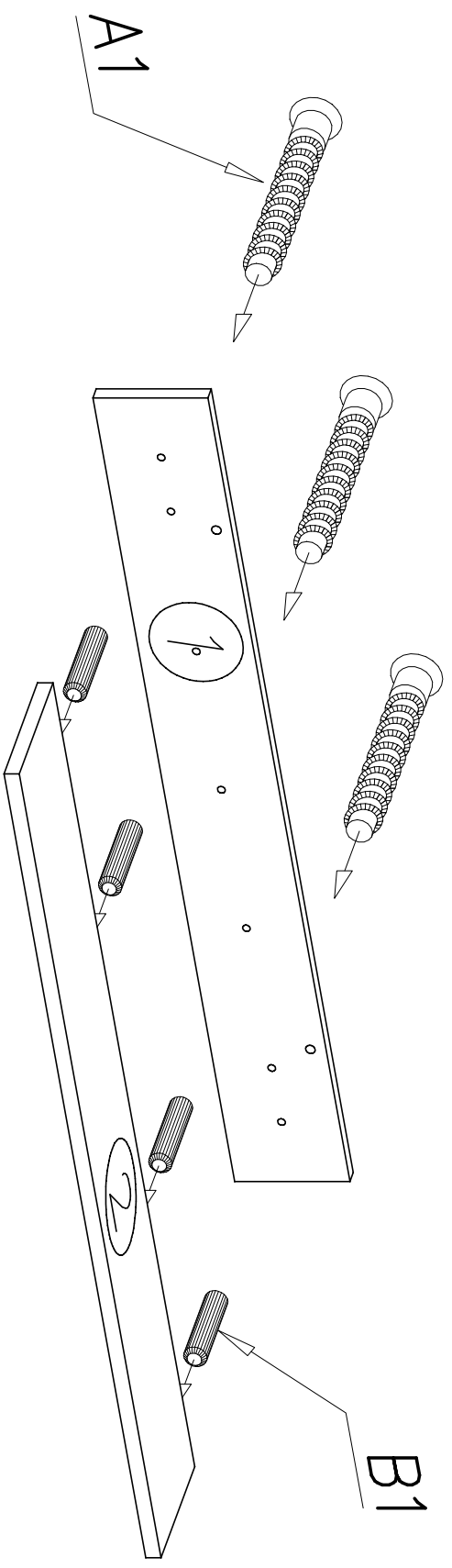

2

