

# TITANUS 08

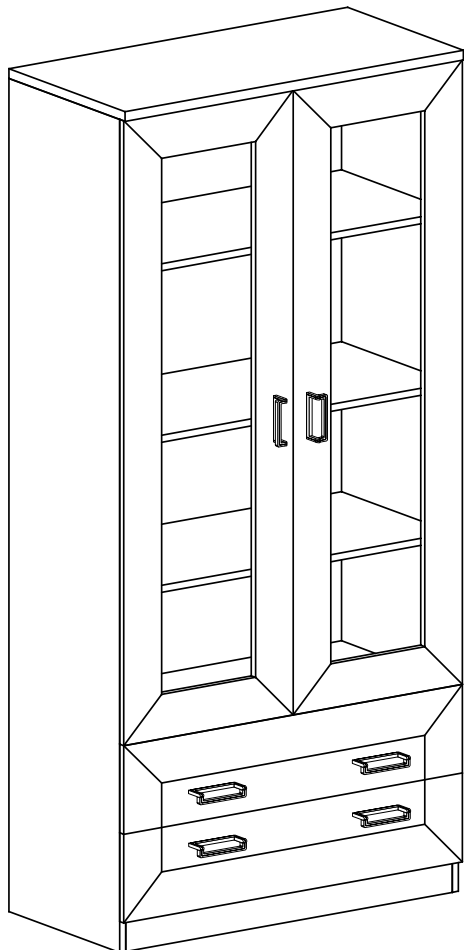

Narzędzia potrzebne do montażu

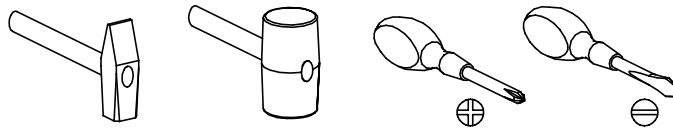

## UWAGA !!!

MONTOWANIE USZKODZONYCH  
ELEMENTÓW POWODUJE UTRATĘ  
GWARANCJI

Nr	D[mm]	S[mm]	G[mm]	Ilość
1	900	440	16	1
2	852	405	16	1
3	852	405	16	1
4	852	80	16	1
5	852	380	16	3
6	1870	405	16	1
7	1870	405	16	1
8	1395	440	16	1
9	1395	440	16	1
10	880	190	16	2
11	400	150	16	2
12	400	150	16	2
13	793	150	16	2
14	825	405	2,5	2
15	1800	876	2,5	1

W przypadku reklamacji proszę podać numer pakowacza znajdujący się na kartonie.

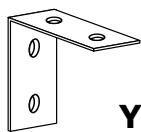

**Y - 1 St.**

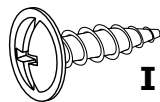

**I - 2 St.**  
3,5x16 mm



**X1 - 8 St.**



**X2 - 8 St.**

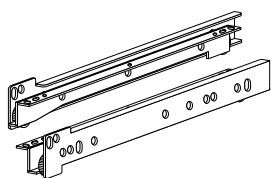

**T - 2 Kpl.**

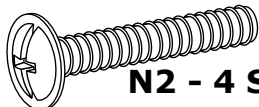

**N2 - 4 St.**  
4x37 mm

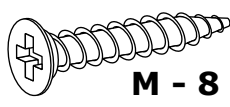

**M - 8 St.**  
3,5x25 mm

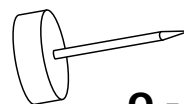

**Q - 5 St.**

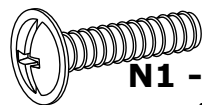

**N1 - 8 St.**  
4x22 mm

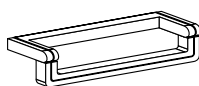

**U - 6 St.**

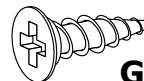

**G - 12 St.**  
3,5x16 mm

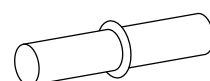

**P - 12 St.**



**F - 8 St.**



**E - 60 St.**

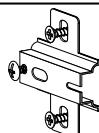

**C - 6 St.**

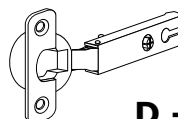

**D - 6 St.**



**L - 8 St.**



**R - 8 St.**

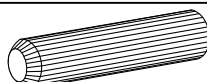

**B - 24 St.**

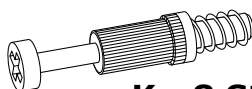

**K - 8 St.**

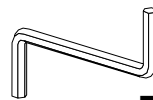

**Z - 1 St.**

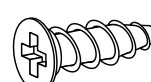

**J - 8 St.**  
5x13 mm

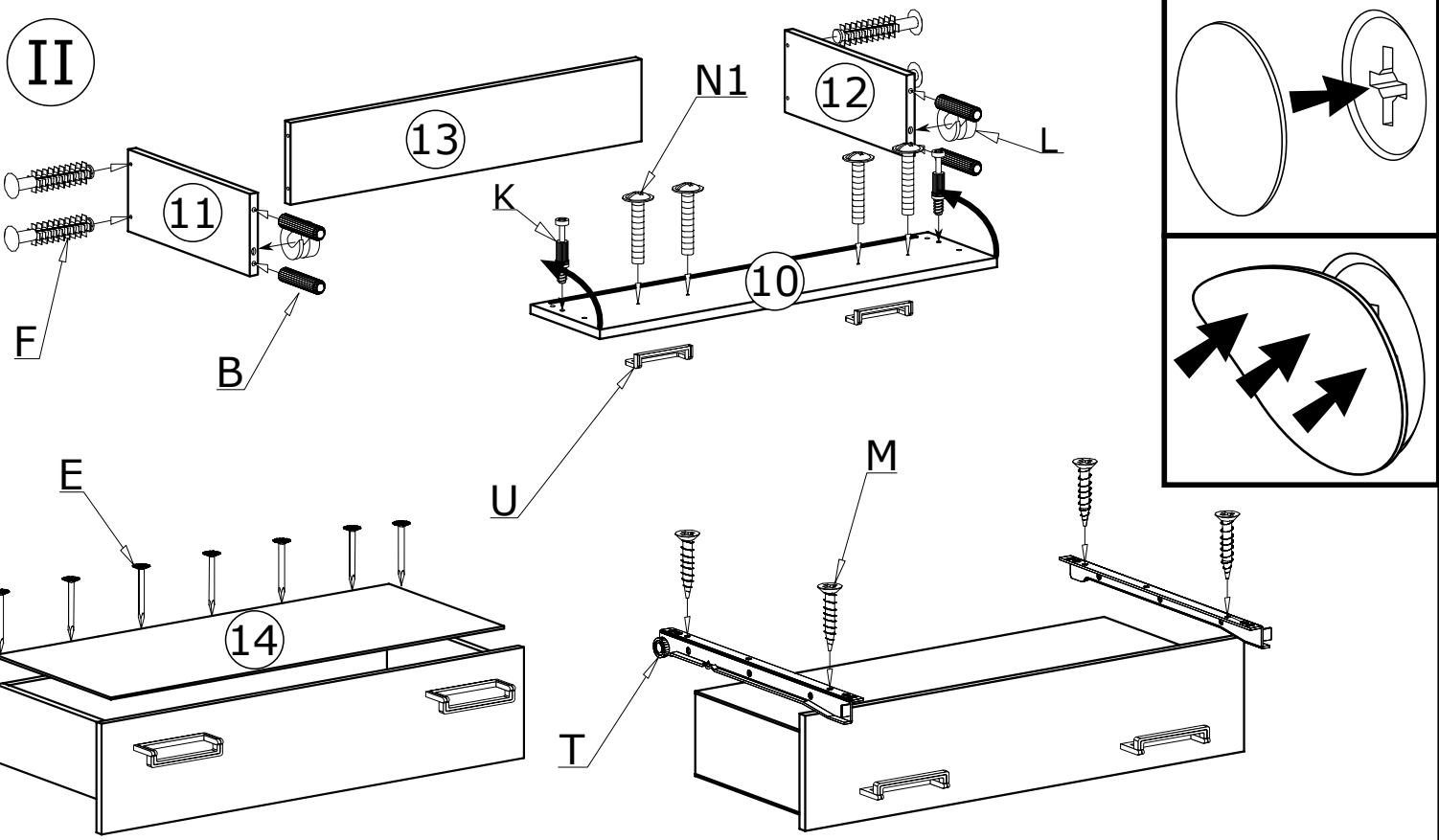
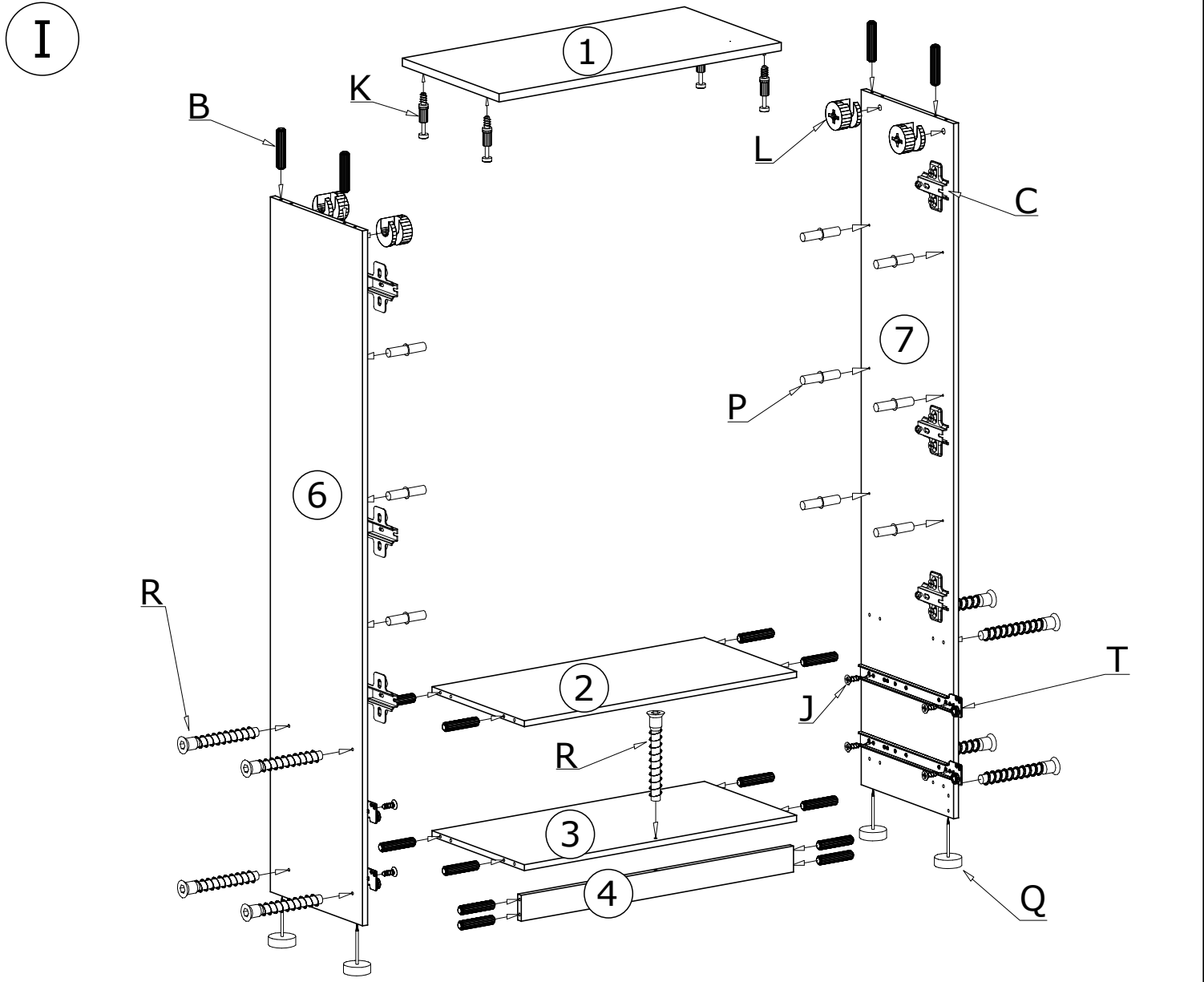

III

60X 

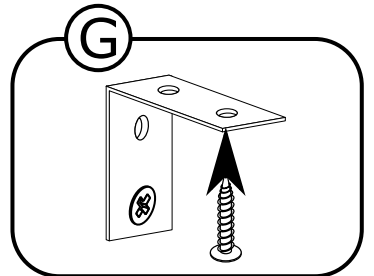
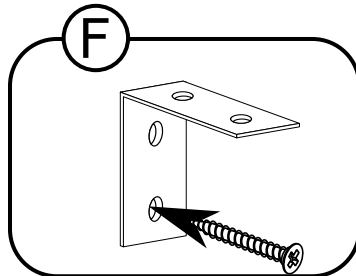
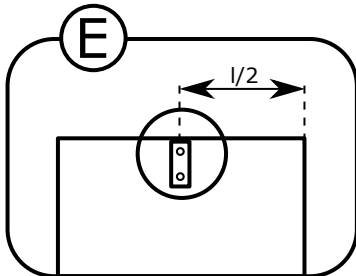
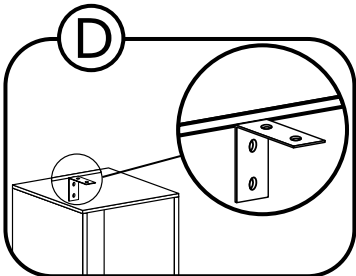
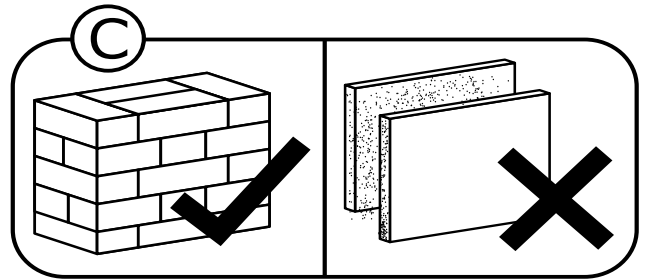
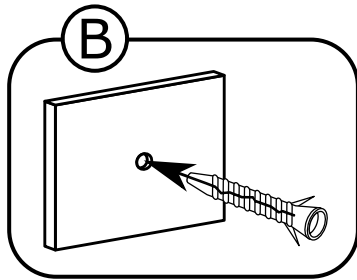
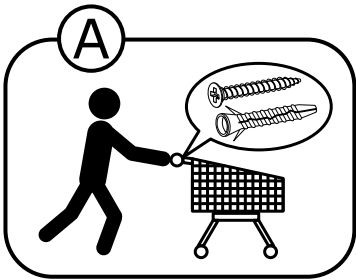
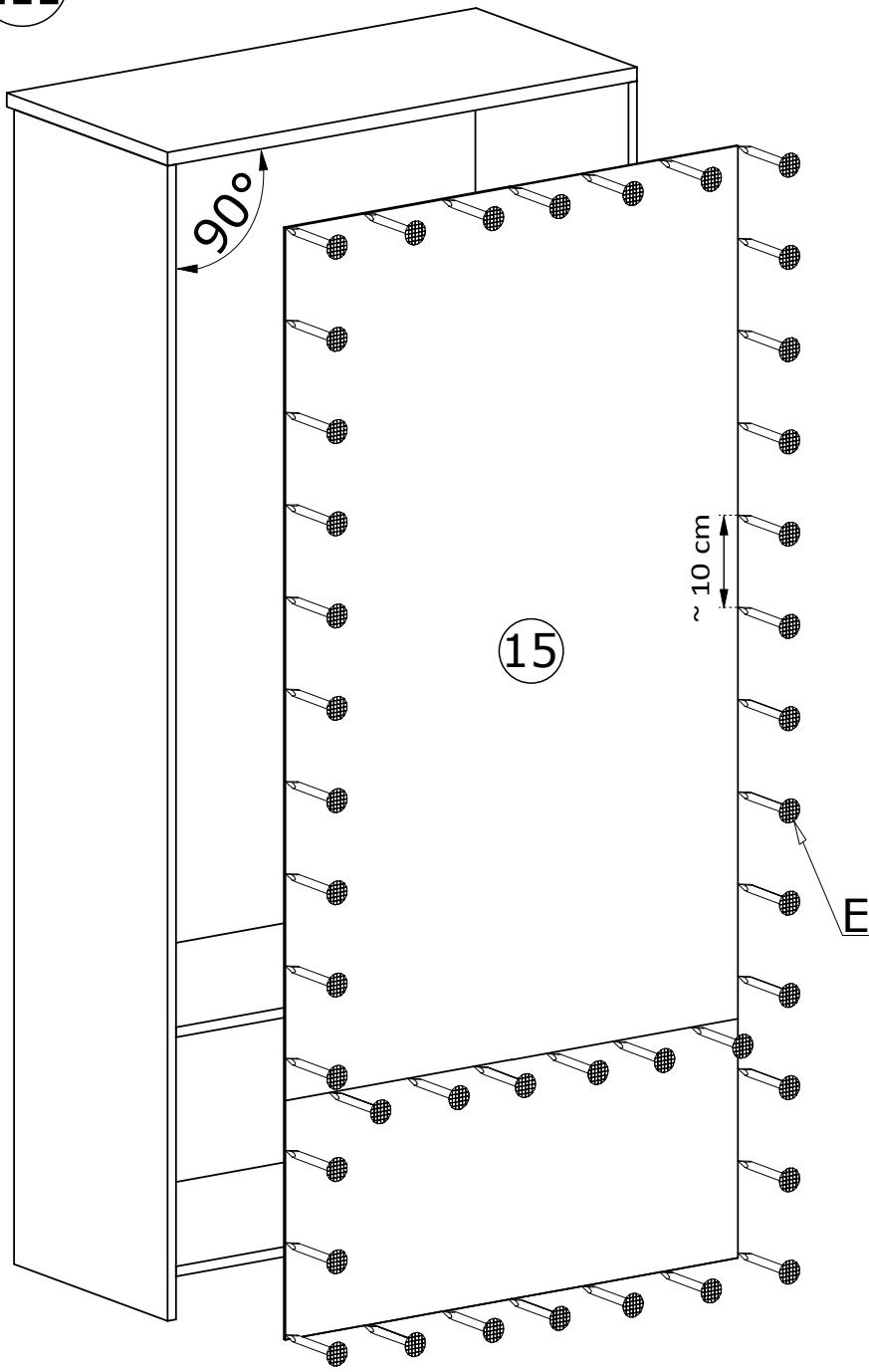

IV

U

