

TITANUS 06

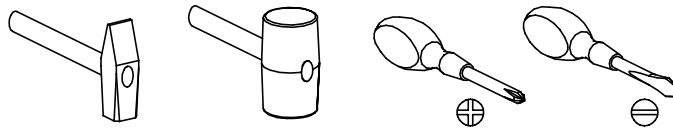

Narzędzia potrzebne do montażu



UWAGA !!!

MONTOWANIE USZKODZONYCH
ELEMENTÓW POWODUJE UTRATĘ
GWARANCJI

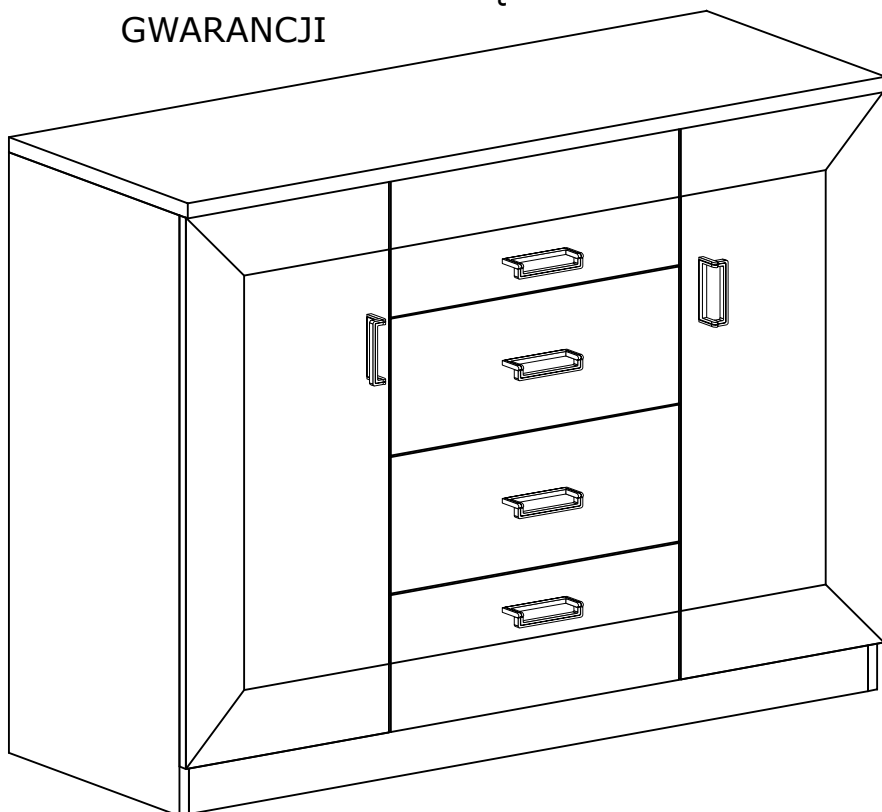

Nr	D[mm]	S[mm]	G[mm]	Ilość
1	1400	440	32	1
2	1353	405	16	1
3	770	405	16	1
4	770	405	16	1
5	866	405	16	1
6	1353	80	16	1
7	1378	806	2,5	1
8	560	150	16	4
9	400	150	16	4
10	400	150	16	4
11	636	190	16	4
12	590	405	2,5	4
13	380	350	16	2
14	776	369	16	1
15	866	405	16	1
16	776	369	16	1

W przypadku reklamacji proszę podać numer pakowacza znajdujący się na kartonie.

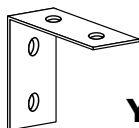

Y - 1 St.



X1 - 20 St.



X2 - 5 St.

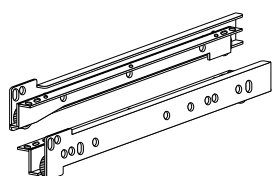

T - 4 Kpl.

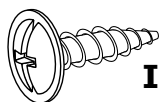

I - 2 St.
3,5x16 mm

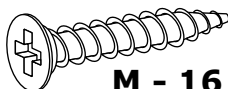

M - 16 St.
4x25 mm

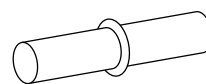

P - 8 St.

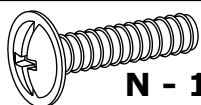

N - 12 St.
4x22 mm

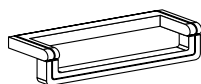

U - 6 St.

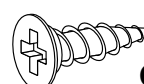

G - 8 St.
3,5x16 mm

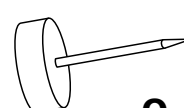

Q - 6 St.

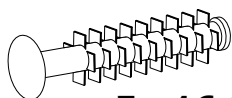

F - 16 St.

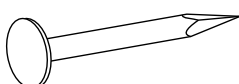

E - 100 St.

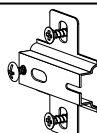

C - 4 St.

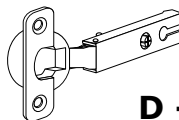

D - 4 St.

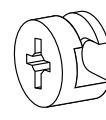

L - 20 St.

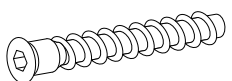

R - 5 St.

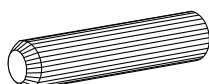

B - 36 St.

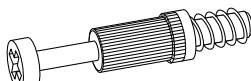

K - 20 St.



Z - 1 St.

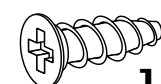

J - 16 St.
5x13 mm

I

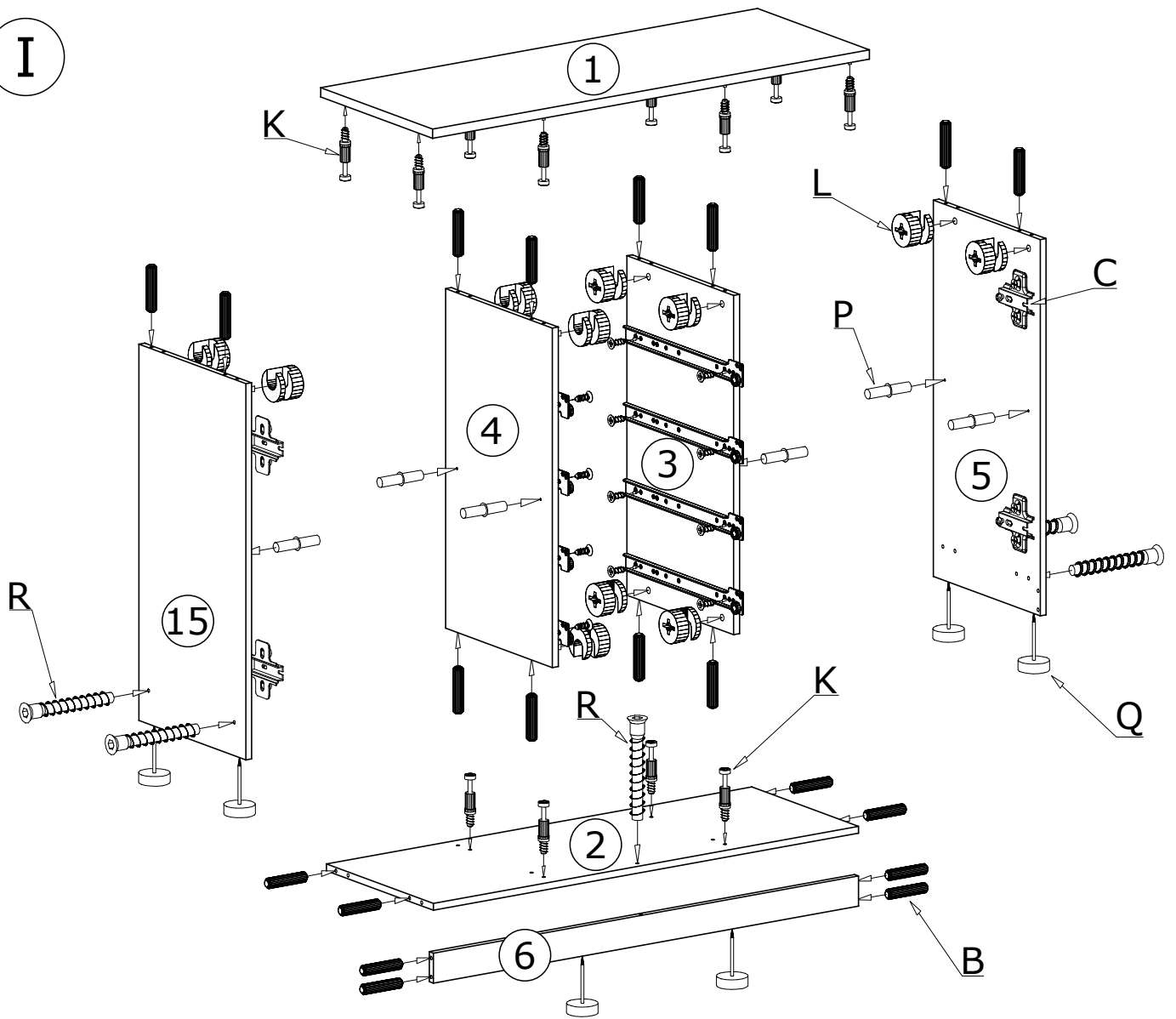

II

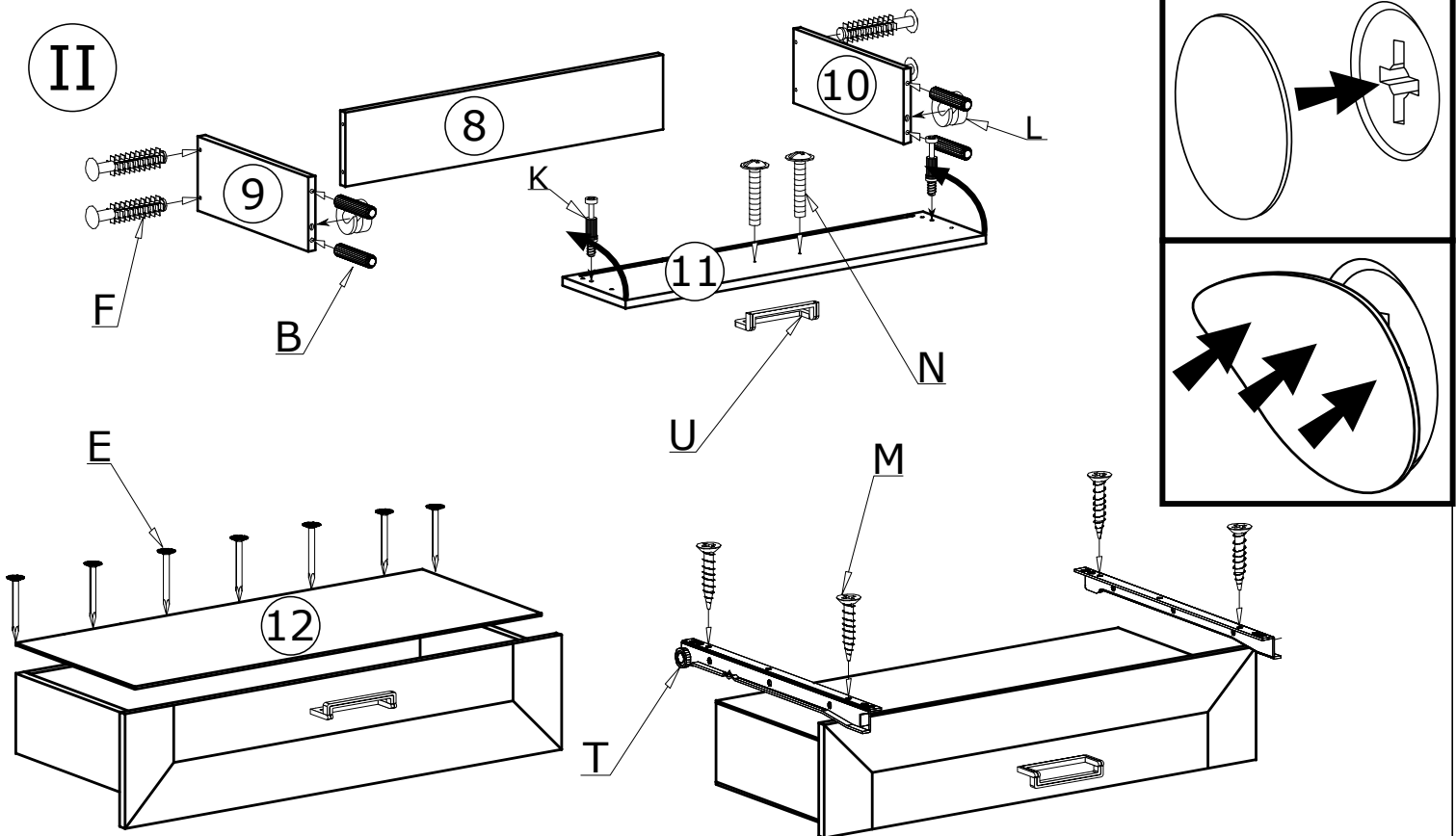

III

120X 

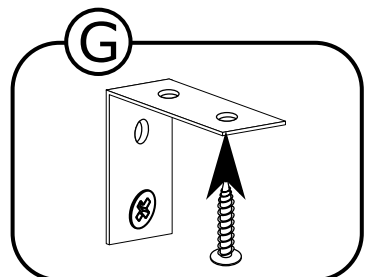
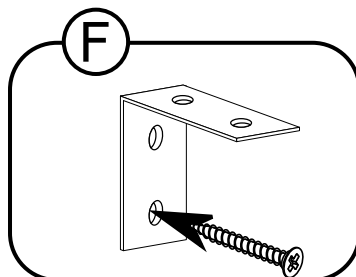
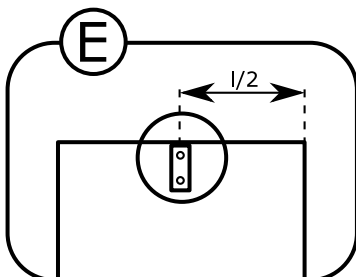
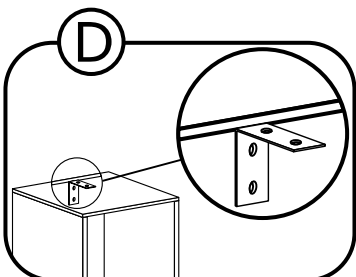
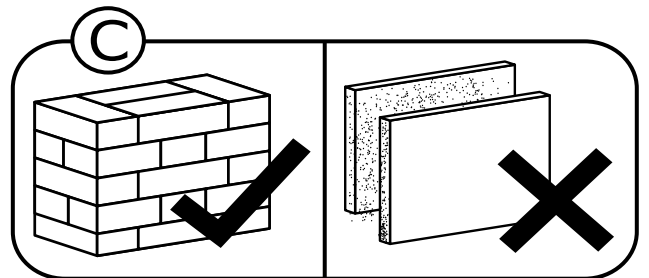
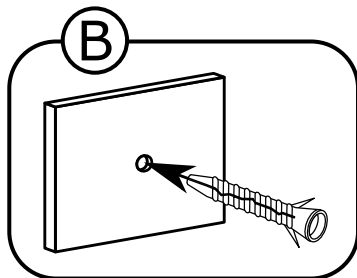
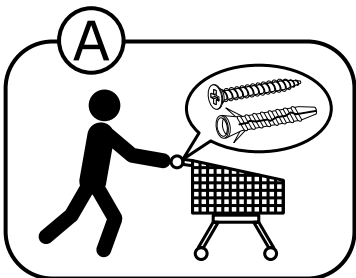
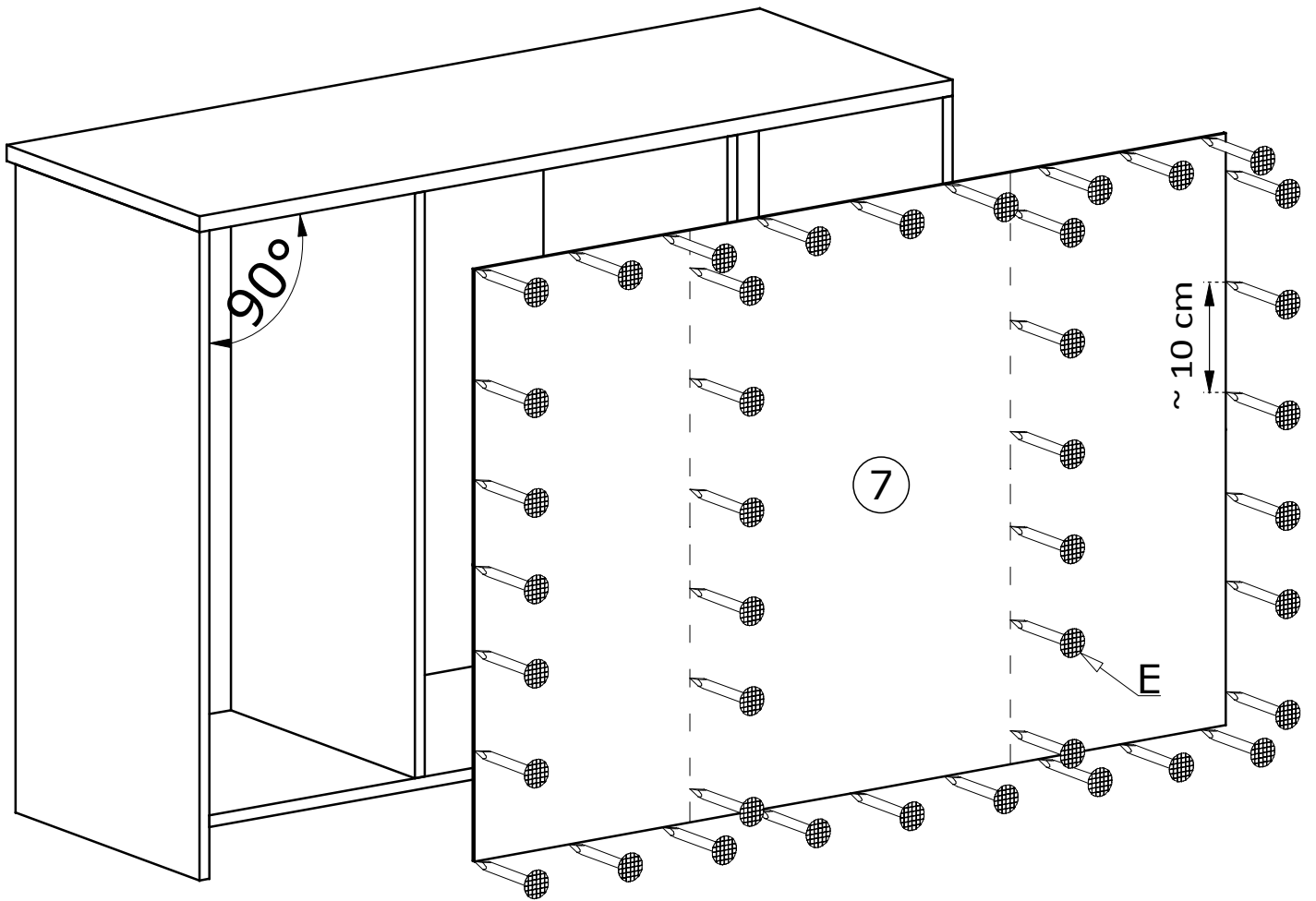

IV

