

# KENNY 15

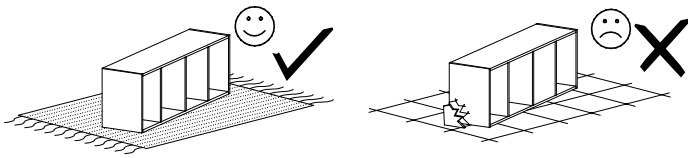

## Narzędzia potrzebne do montażu

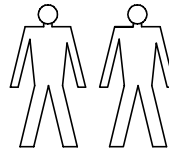
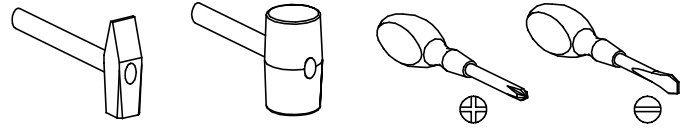

### **UWAGA !!!**

MONTOWANIE USZKODZONYCH  
ELEMENTÓW POWODUJE UTRATĘ  
GWARANCJI

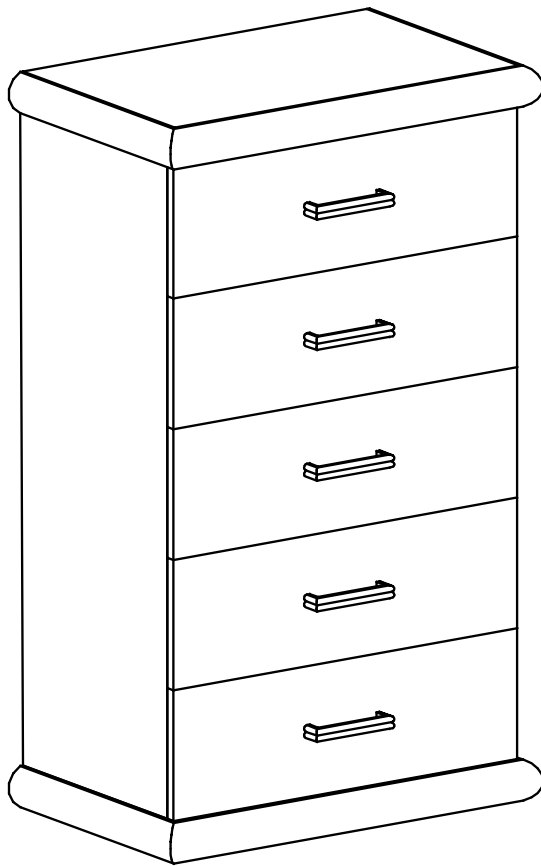

Nr	D[mm]	S[mm]	G[mm]	Ilość
1	700	450	65	1
2	700	450	65	1
3	1020	410	16	1
4	1020	410	16	1
5	1045	634	2,5	1
6	580	355	2,5	5
7	350	150	16	10
8	552	150	16	5
9	635	190	16	5

### **UWAGA !!!**

Mebel zawiera  
elementy drewniane

W przypadku reklamacji proszę podać numer pakowacza znajdujący się na kartonie.

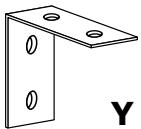

**Y - 1 St.**

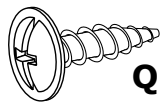

**Q - 2 St.**  
3,5x16 mm

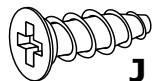

**J - 40 St.**  
5x13 mm

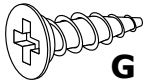

**G - 16 St.**  
3,5x16 mm



**X1 - 34 St.**

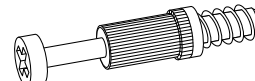

**K - 18 St.**



**L - 18 St.**

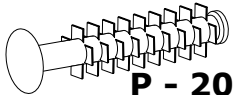

**P - 20 St.**  
7x50 mm

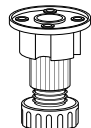

**F - 4 St.**

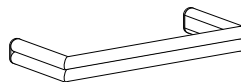

**U - 5 St.**

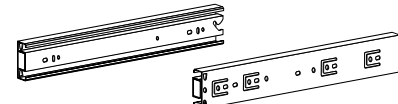

**T - 5 Kpl.**

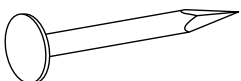

**E - 50 St.**

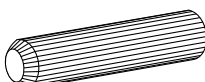

**B - 28 St.**

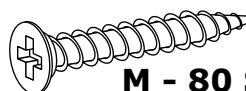

**M - 80 St.**  
3x30 mm

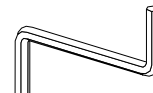

**Z - 1 St.**

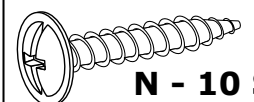

**N - 10 St.**  
4x27 mm

I

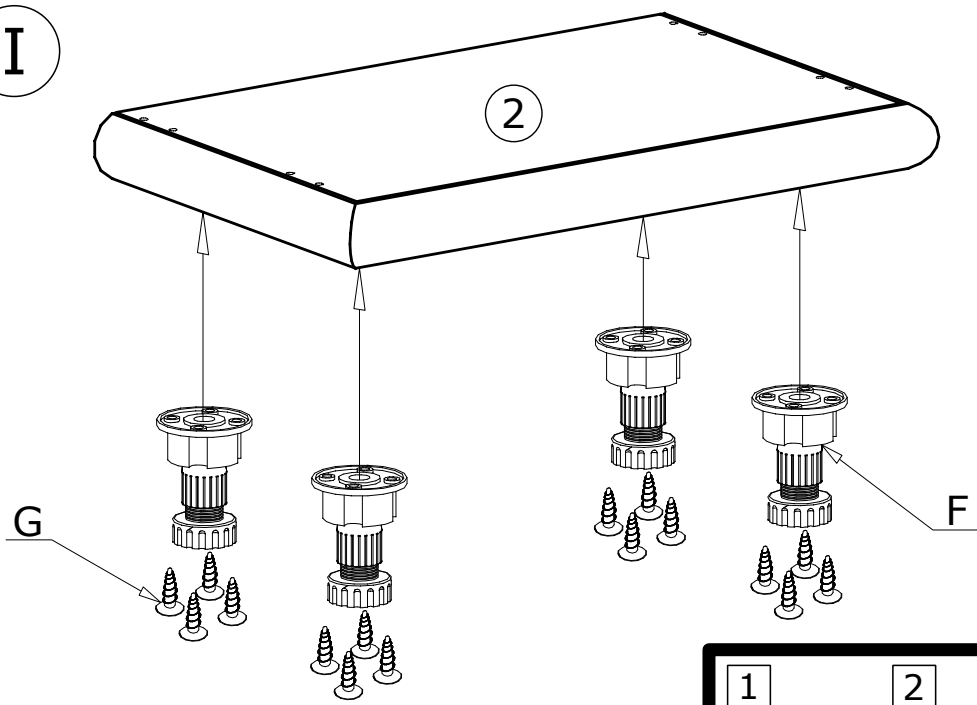

II

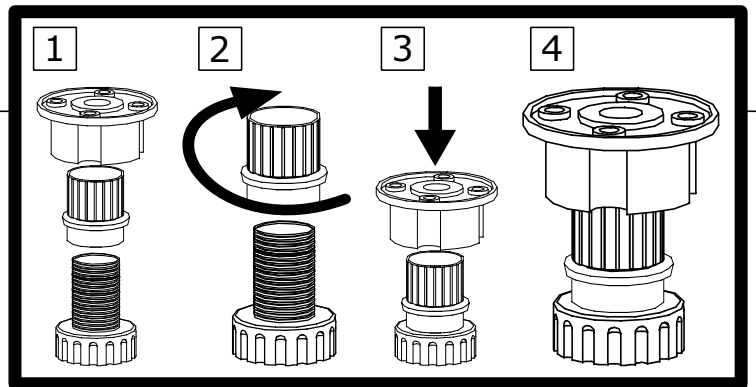
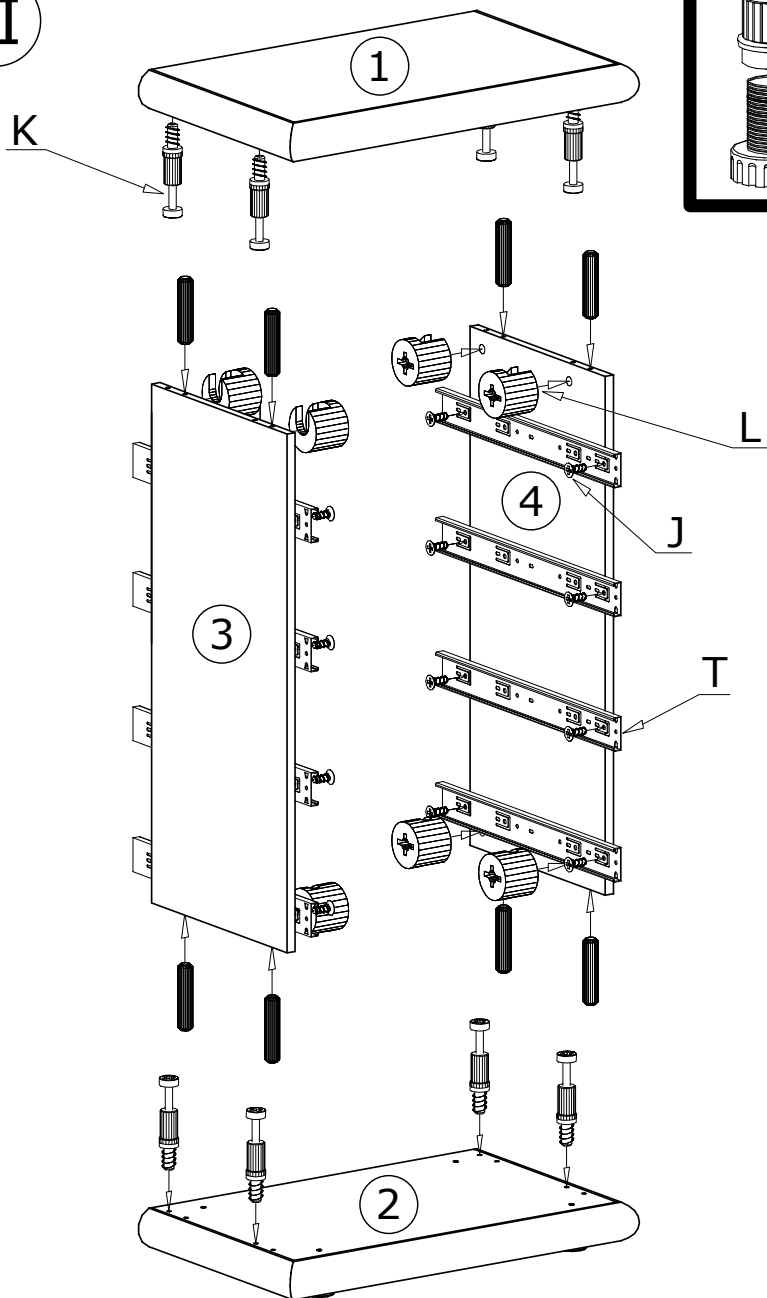

III

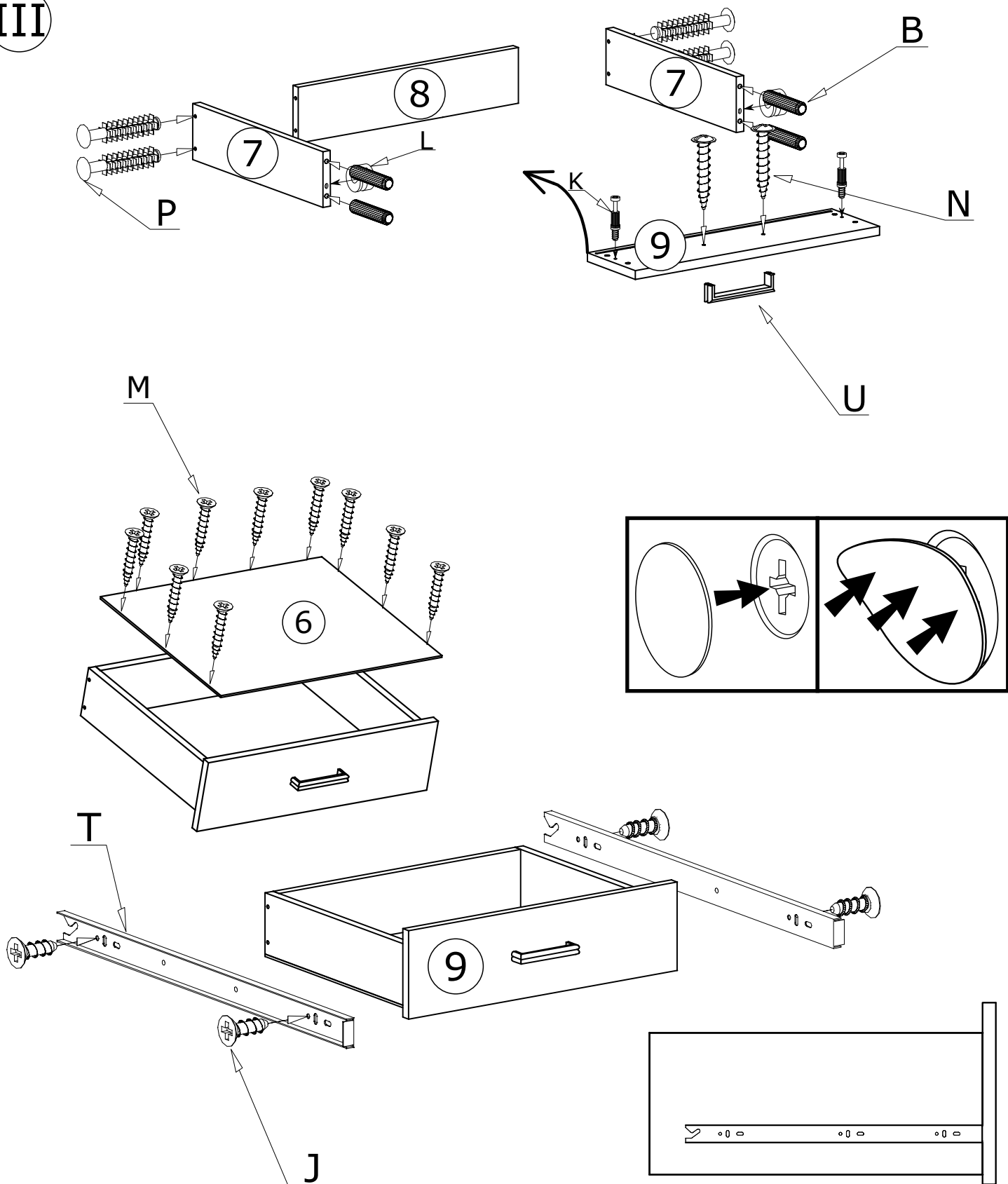

Meble zawierają elementy drewniane, których barwa i układ słoju są uzależnione od wielu czynników, dlatego mogą występować różnice w fakturze i barwie co nie stanowi wady produktu i nie wpływa na jego jakość, trwałość i funkcjonalność.

Listwy drewniane mogą ujawniać niewielkie zmiany w kształcie i wymiarach wywołane specyficznymi warunkami eksploatacji takimi jak: wilgotność, różnice temperatur, etc.

IV

50X 

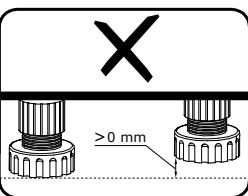
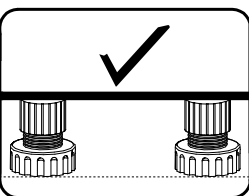
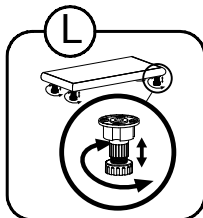
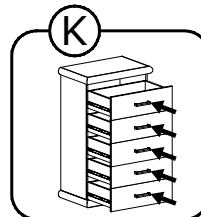
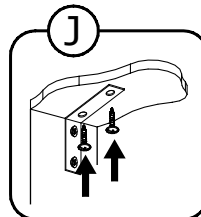
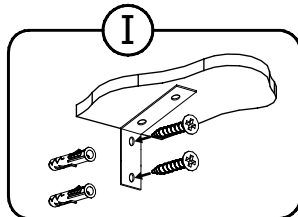
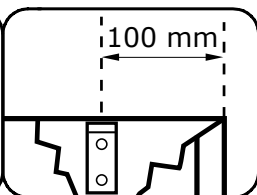
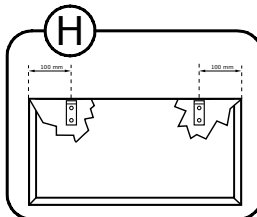
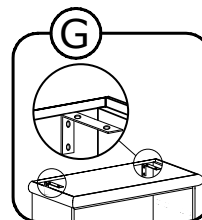
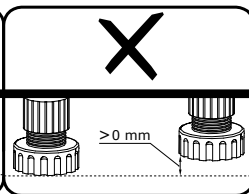
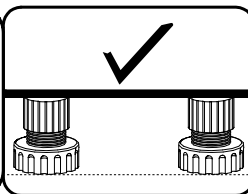
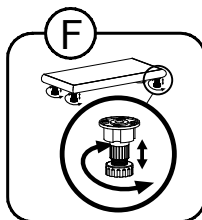
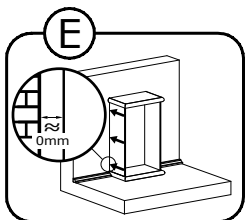
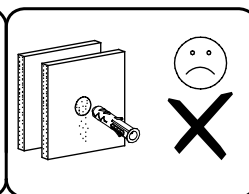
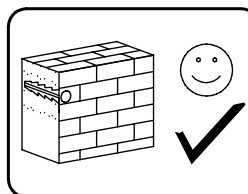
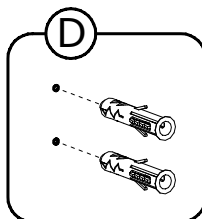
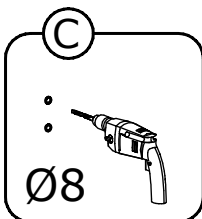
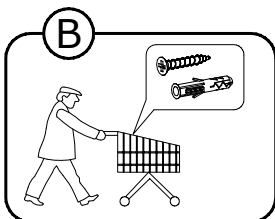
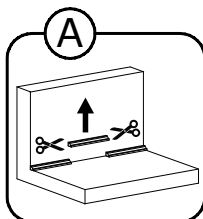
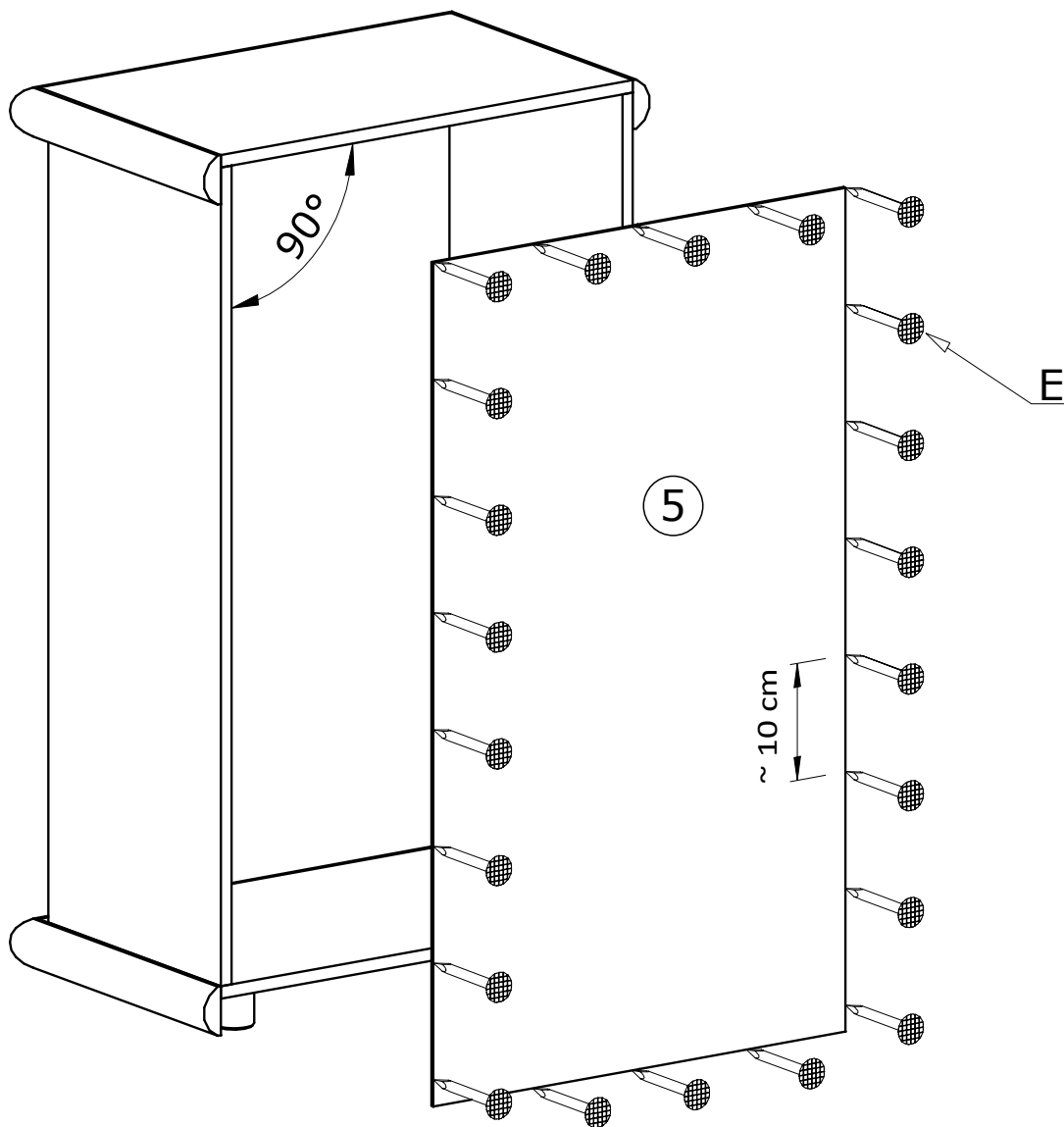

V

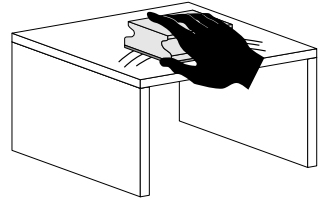
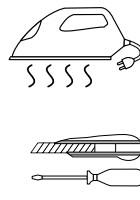
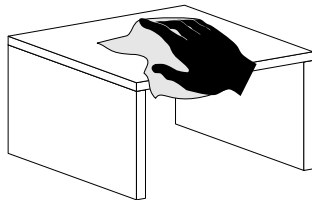
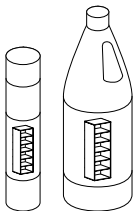
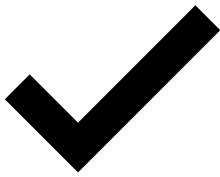
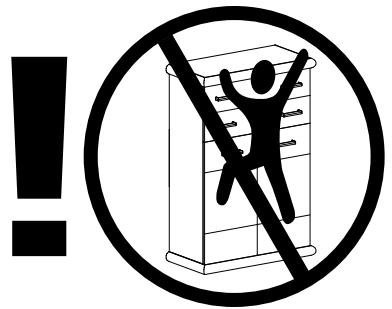
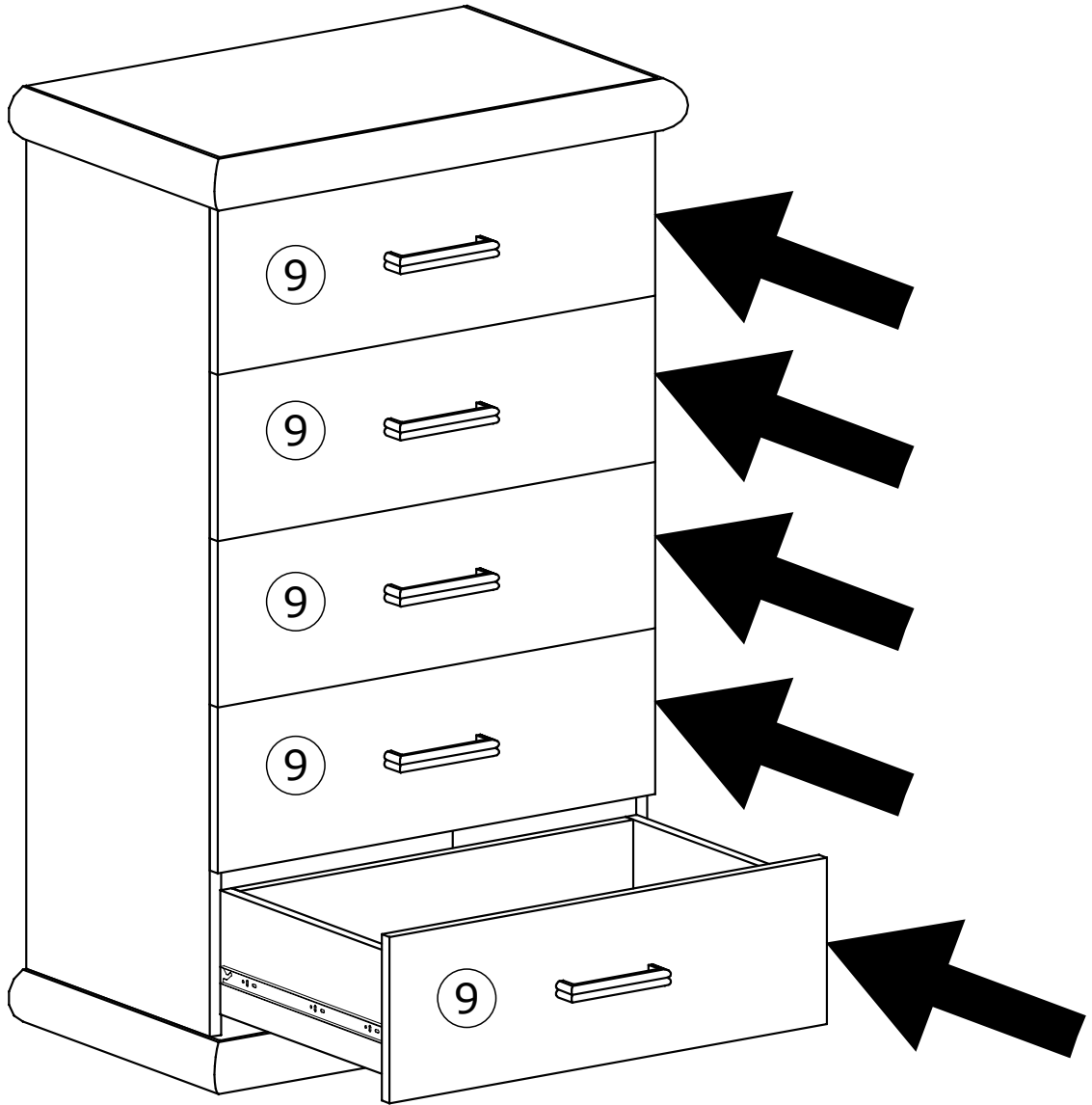

# MONTAŻ/DEMONTAŻ PROWADNIC

1



2

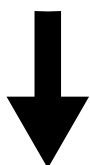
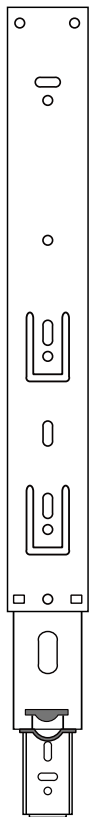

3



4

