

KENNY 10

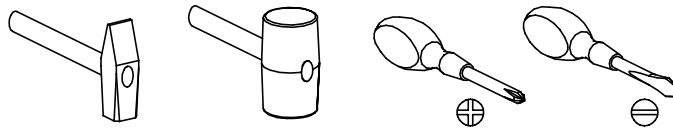

Narzędzia potrzebne do montażu



UWAGA !!!

MONTOWANIE USZKODZONYCH
ELEMENTÓW POWODUJE UTRATĘ
GWARANCJI

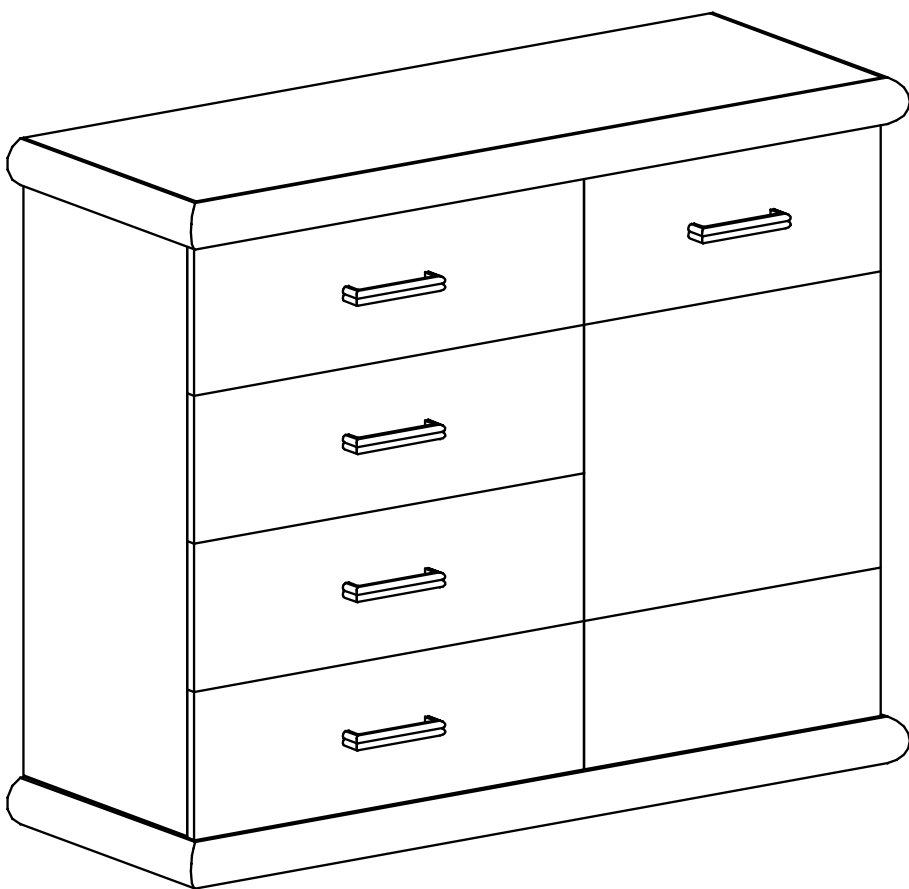

Nr	D[mm]	S[mm]	G[mm]	Ilość
1	1155	450	65	1
2	1155	450	65	1
3	830	410	16	1
4	830	410	16	1
5	830	410	16	1
6	1088	852	2,5	1
7	432	380	16	1
8	770	450	16	1
9	590	355	2,5	4
10	350	150	16	8
11	560	150	16	4
12	635	190	16	4

UWAGA !!!

Mebel zawiera
elementy drewniane

W przypadku reklamacji proszę podać numer pakowacza znajdujący się na kartonie.

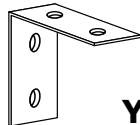

Y - 1 St.

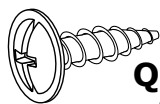

Q - 2 St.
3,5x16 mm

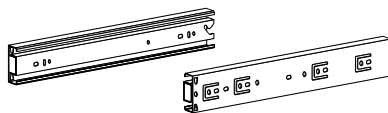

T - 4 Kpl.



X1 - 8 St.



J - 32 St.
5x13 mm

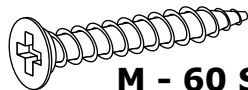

M - 60 St.
3x30 mm

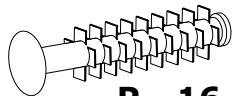

P - 16 St.

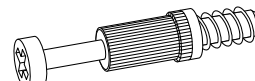

K - 12 St.

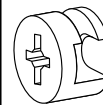

L - 12 St.

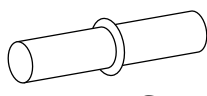

S - 4 St.

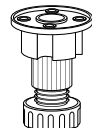

F - 5 St.



U - 5 St.

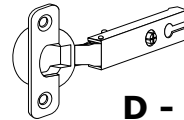

D - 2 St.

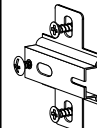

C - 2 St.

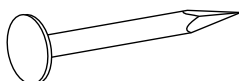

E - 50 St.

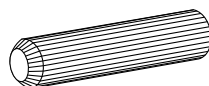

B - 28 St.

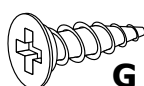

G - 24 St.
3,5x16 mm

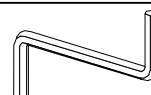

Z - 1 St.

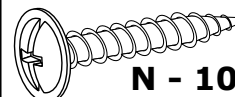

N - 10 St.
4x27 mm

I

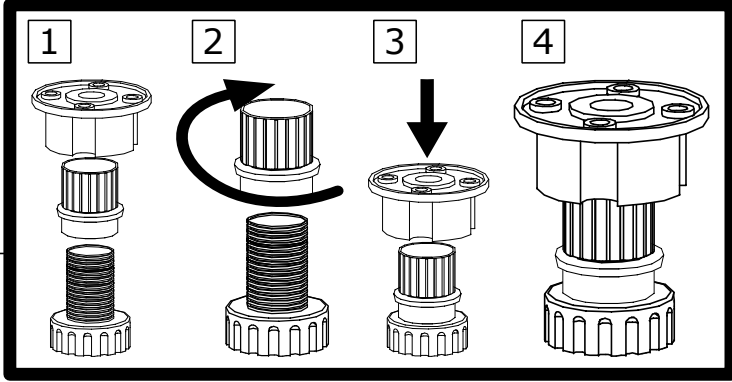
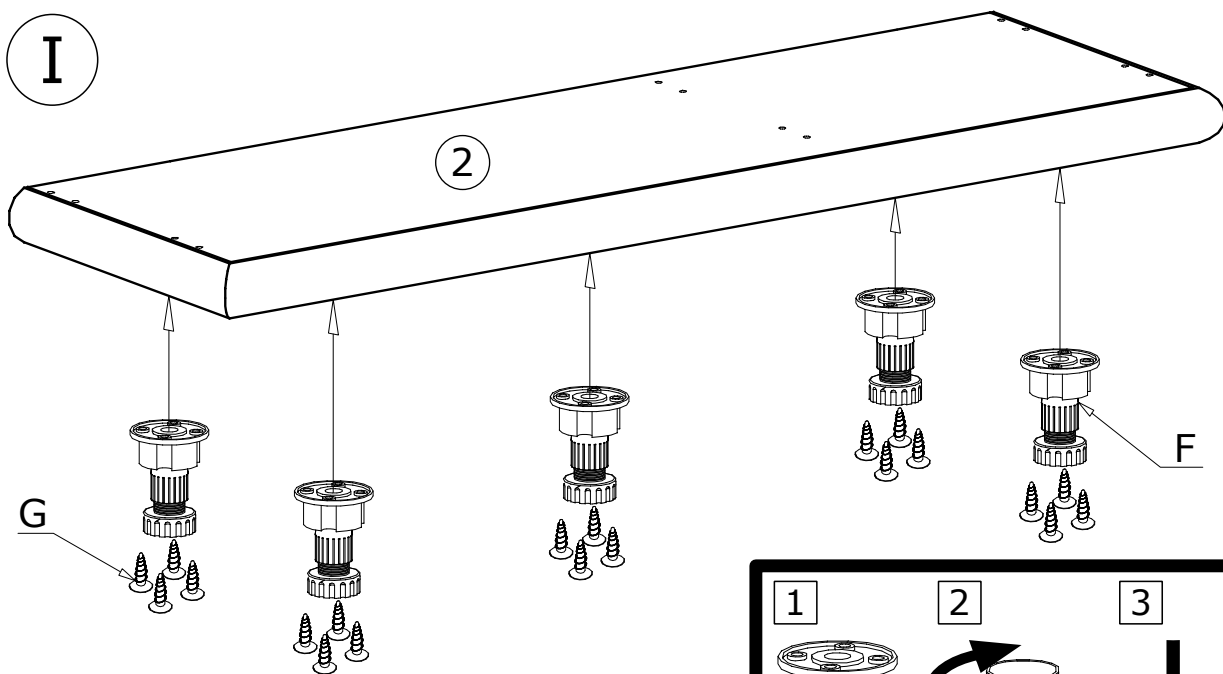

II

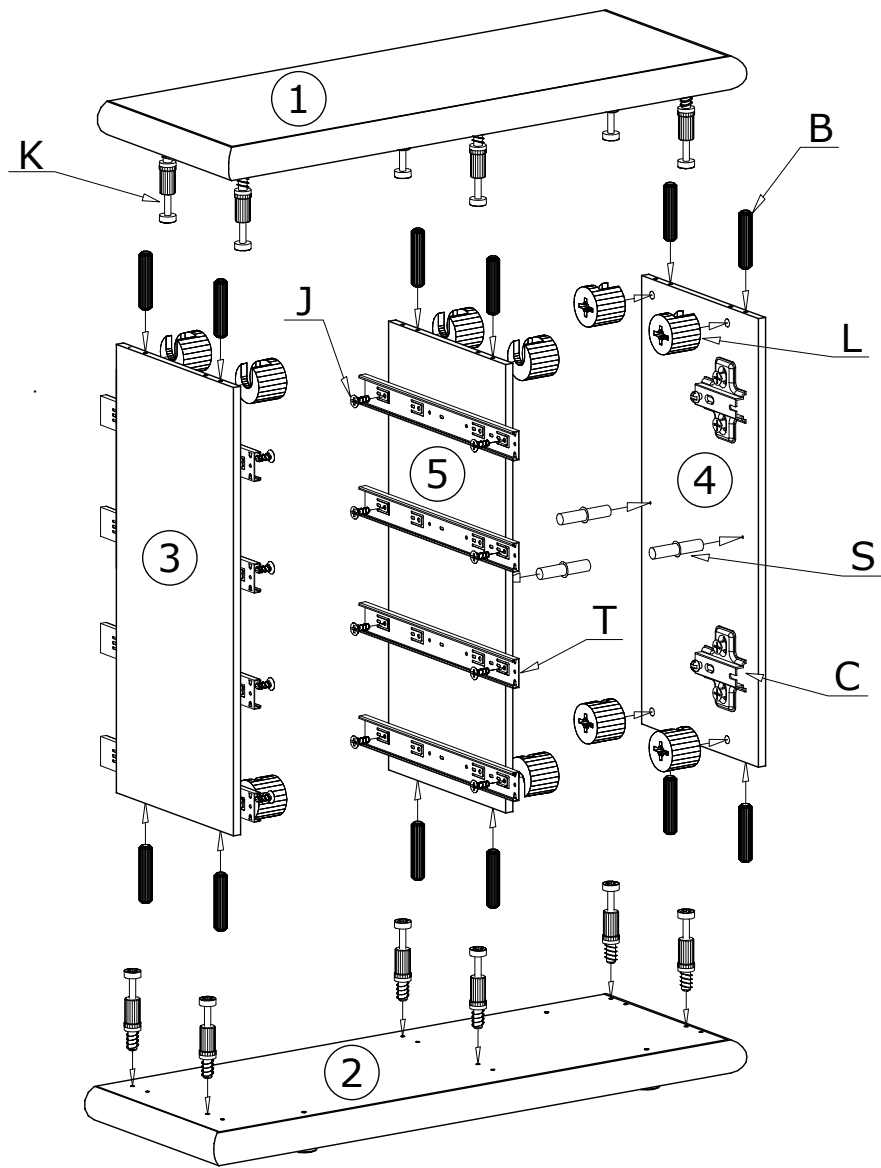

III

50X 

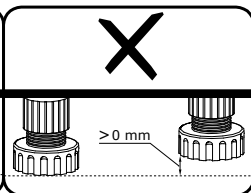
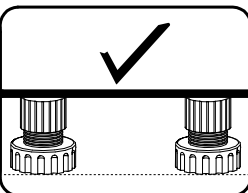
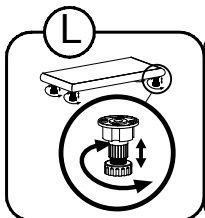
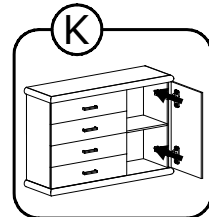
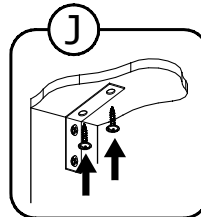
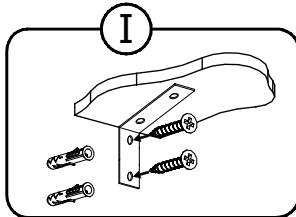
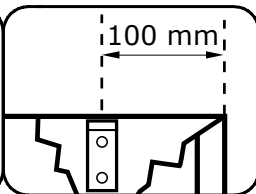
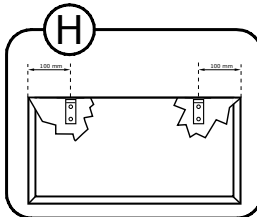
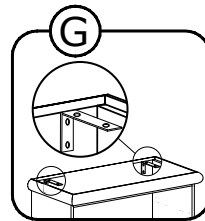
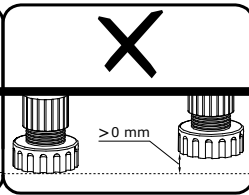
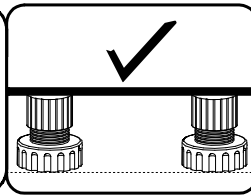
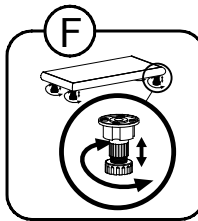
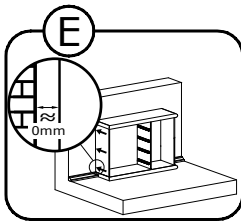
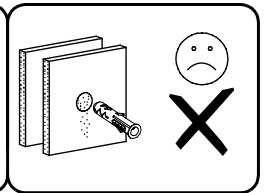
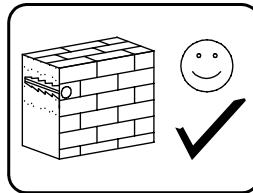
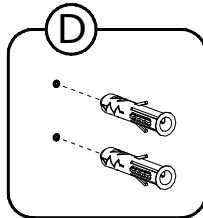
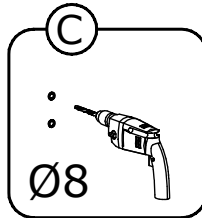
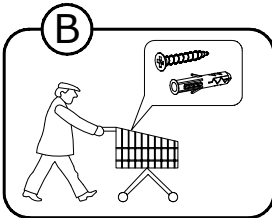
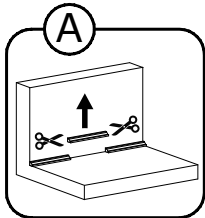
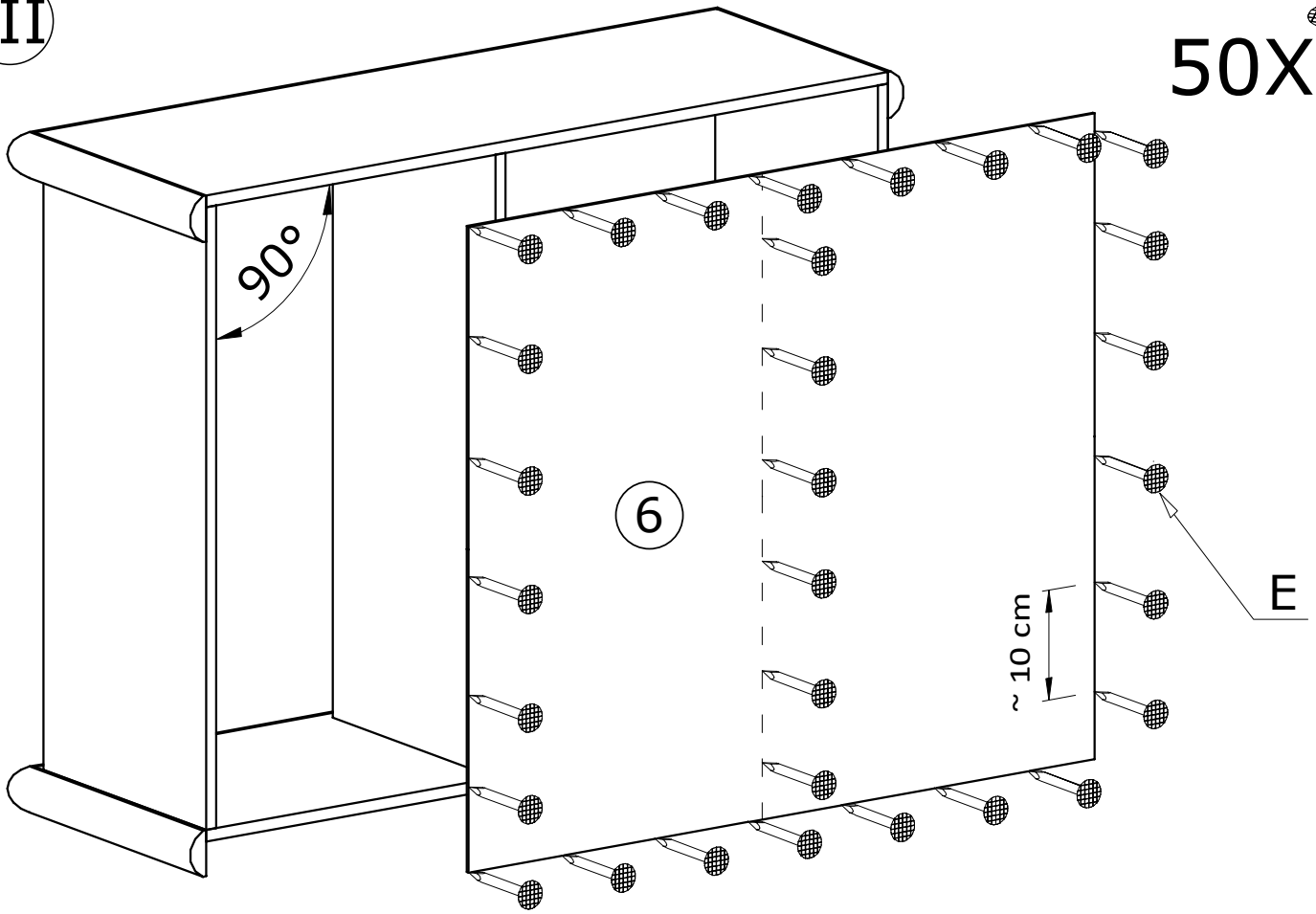

IV

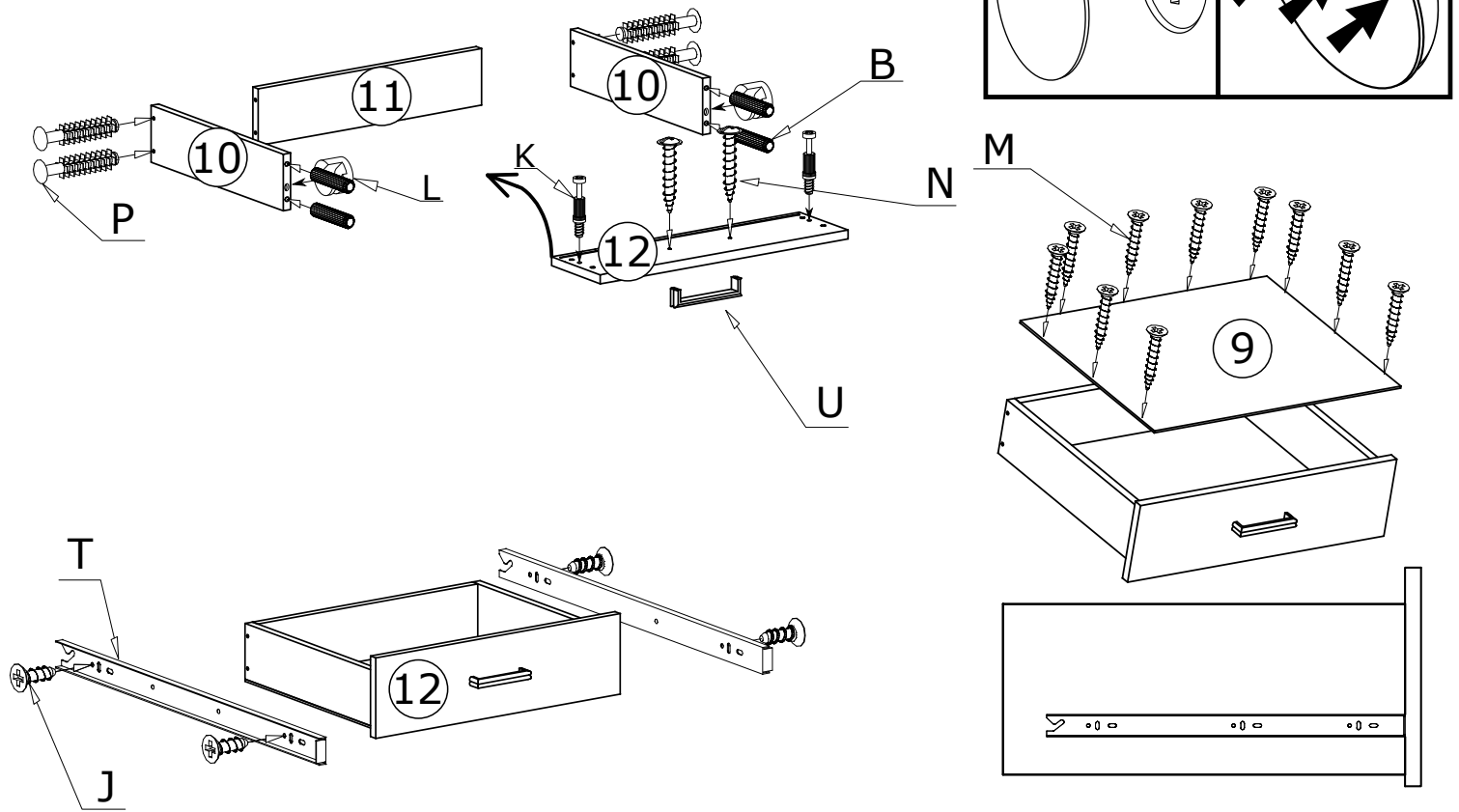

V

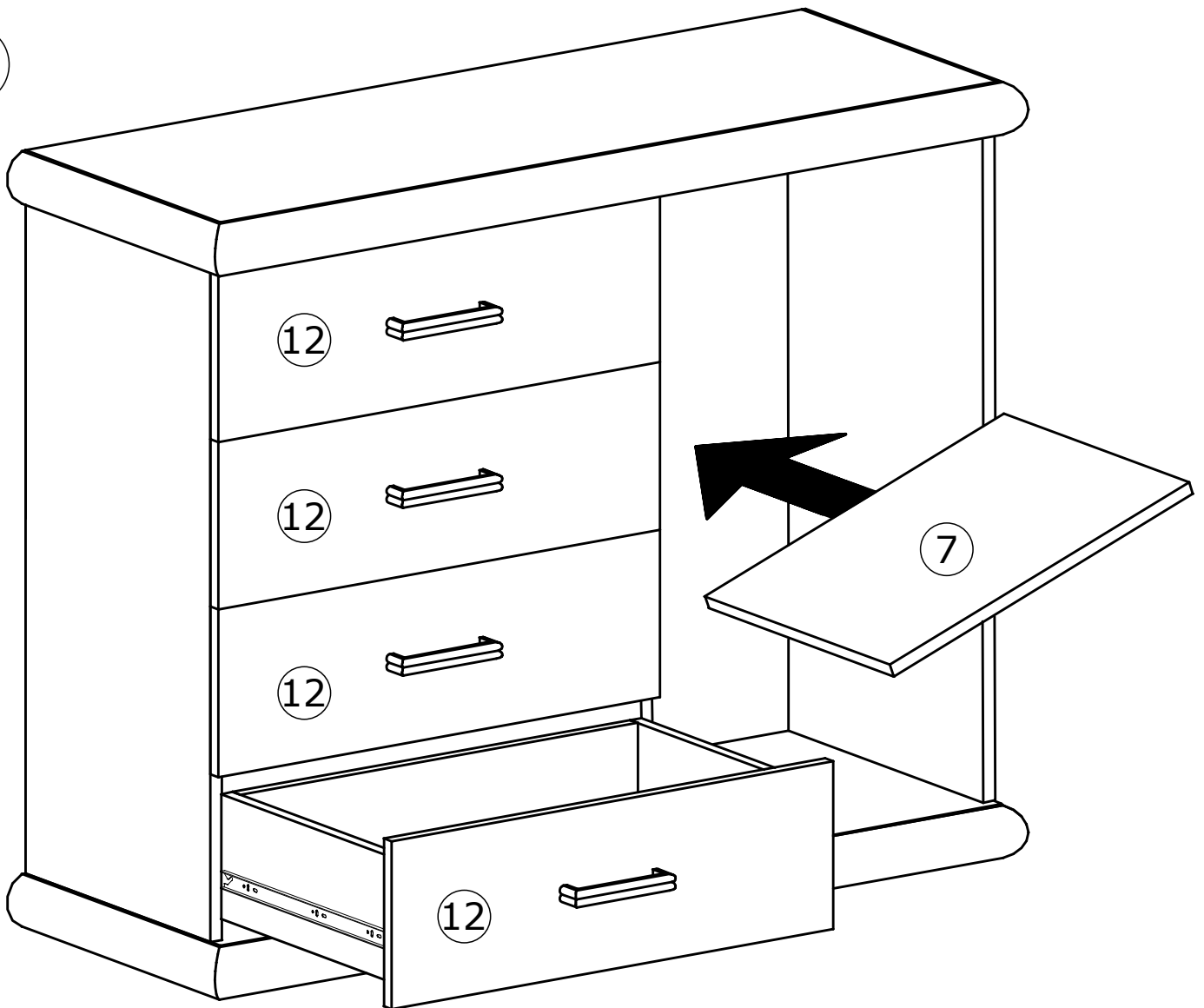

VI

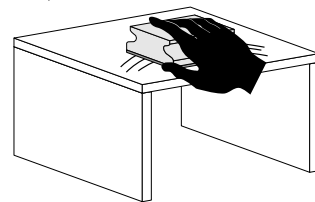
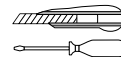
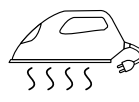
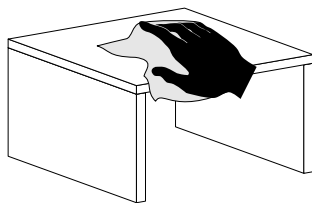
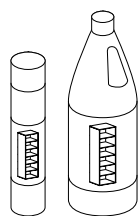
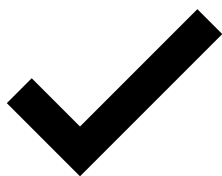
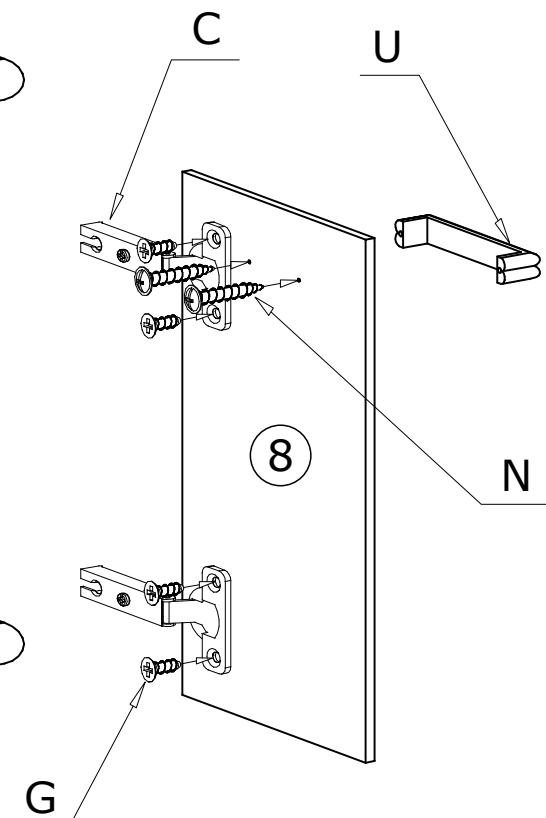
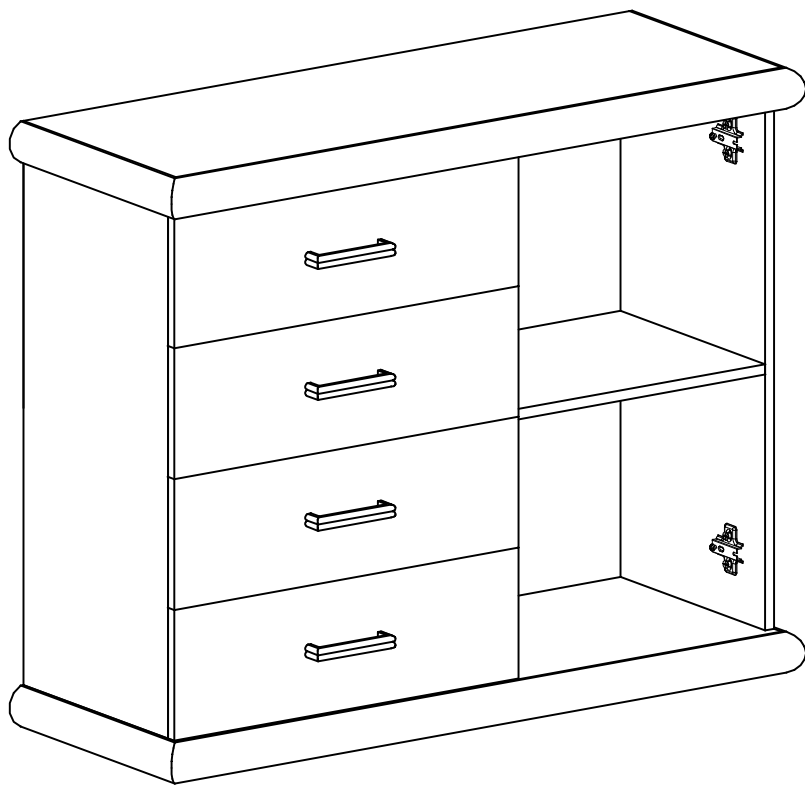

Meble zawierają elementy drewniane, których barwa i układ słoików są uzależnione od wielu czynników, dlatego mogą występować różnice w fakturze i barwie co nie stanowi wady produktu i nie wpływa na jego jakość, trwałość i funkcjonalność.

Listwy drewniane mogą ujawniać niewielkie zmiany w kształcie i wymiarach wywołane specyficznymi warunkami eksploatacji takimi jak: wilgotność, różnice temperatur, etc.

MONTAŻ/DEMONTAŻ PROWADNIC

1



2



3

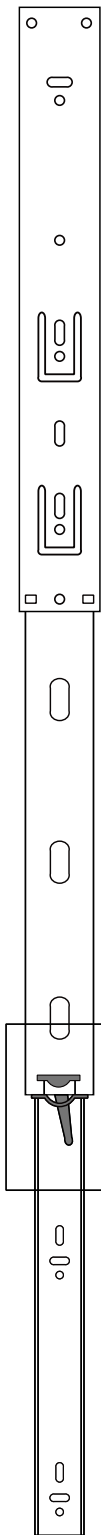

4

