

INDIE 05

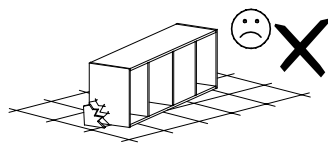

Narzędzia potrzebne do montażu

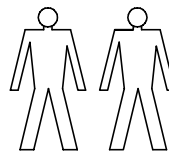
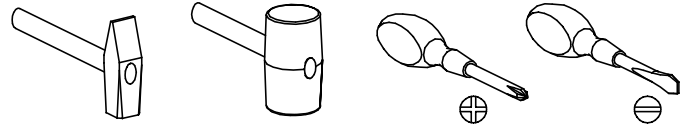

UWAGA !!!

MONTOWANIE USZKODZONYCH
ELEMENTÓW POWODUJE UTRATĘ
GWARANCJI

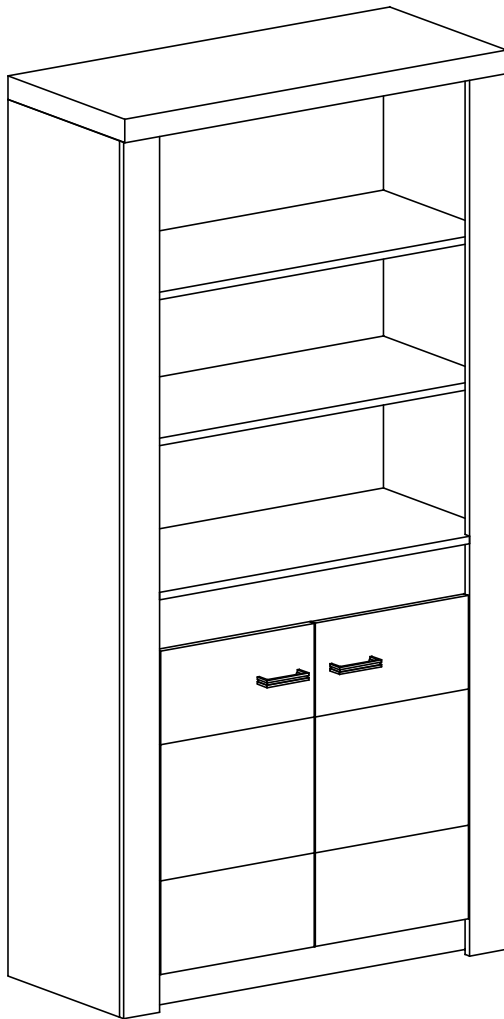

Nr	D[mm]	S[mm]	G[mm]	Ilość
1	927	422	16	1
2	1870	403	16	1
3	1870	403	16	1
4	927	403	16	1
5	927	80	16	1
6	927	123	16	1
7	1800	950	2,5	1
8	927	380	16	3
9	1870	80	16	1
10	1870	80	16	1
11	960	422	48	1
12	665	395	16	1
13	665	395	16	1

UWAGA !!!

Mebel zawiera
elementy drewniane

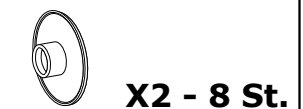
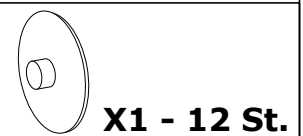

W przypadku reklamacji proszę podać numer pakowacza znajdujący się na kartonie.

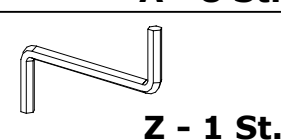
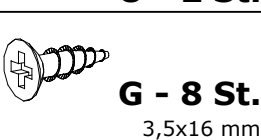
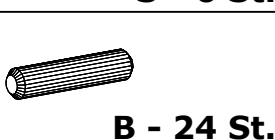
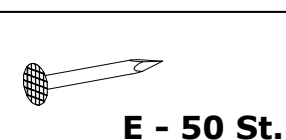
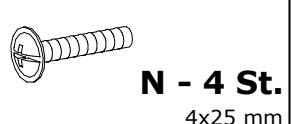
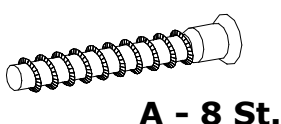
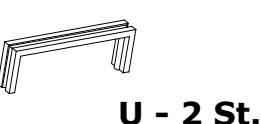
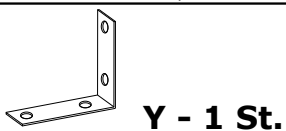
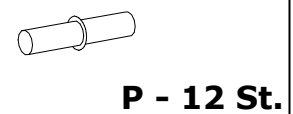
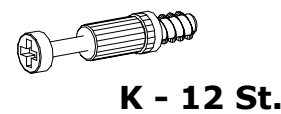
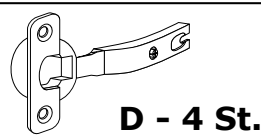
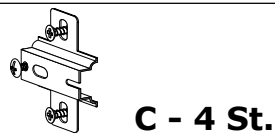
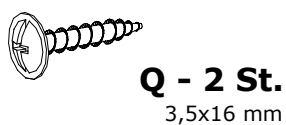

I

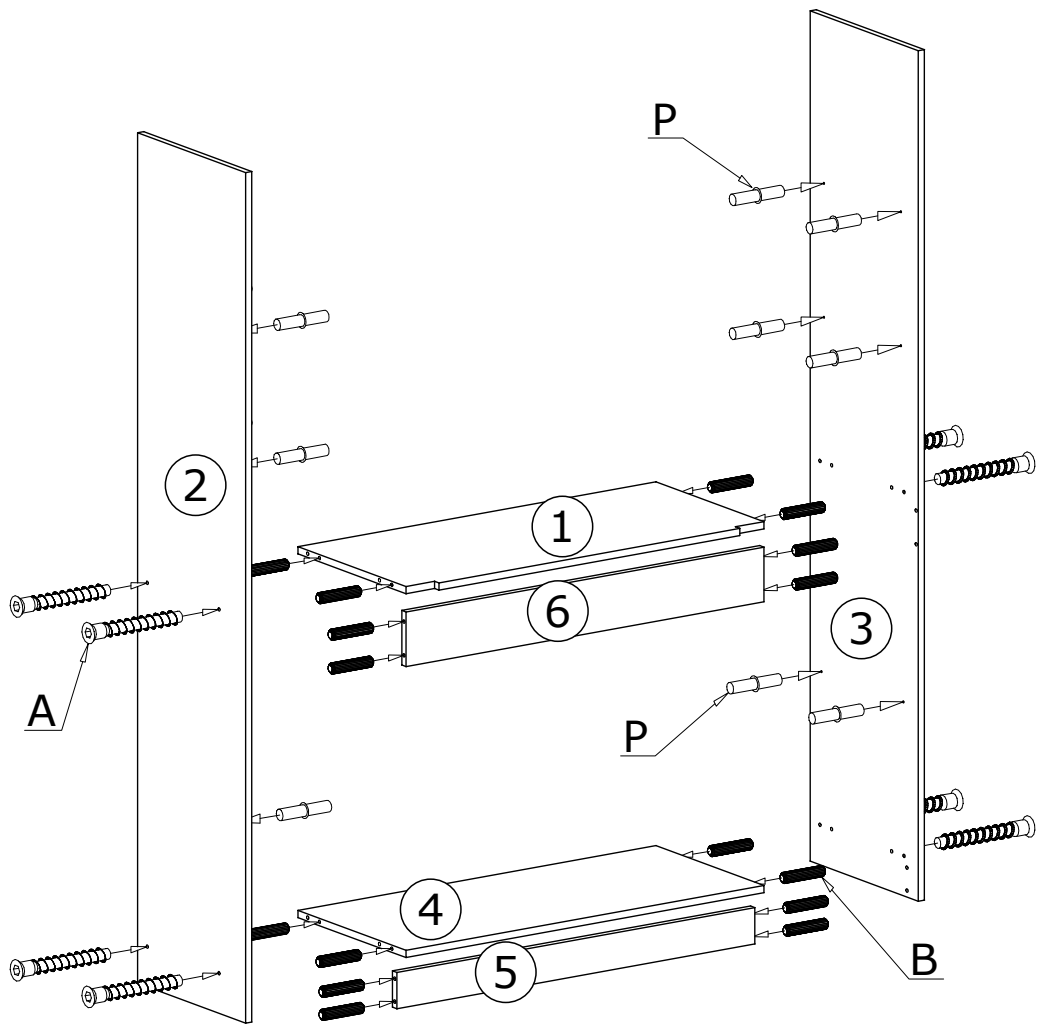

II

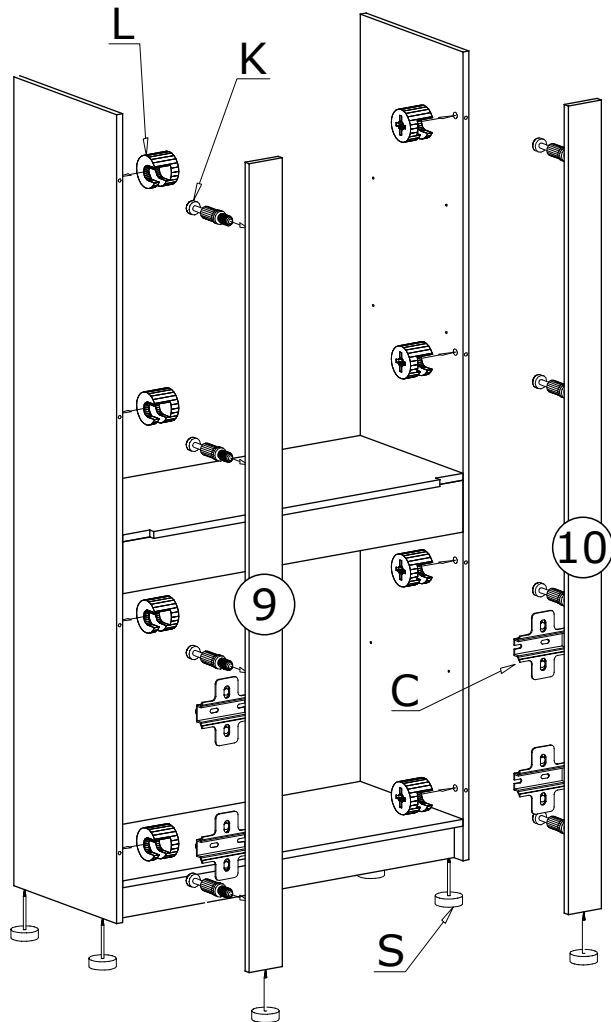

III

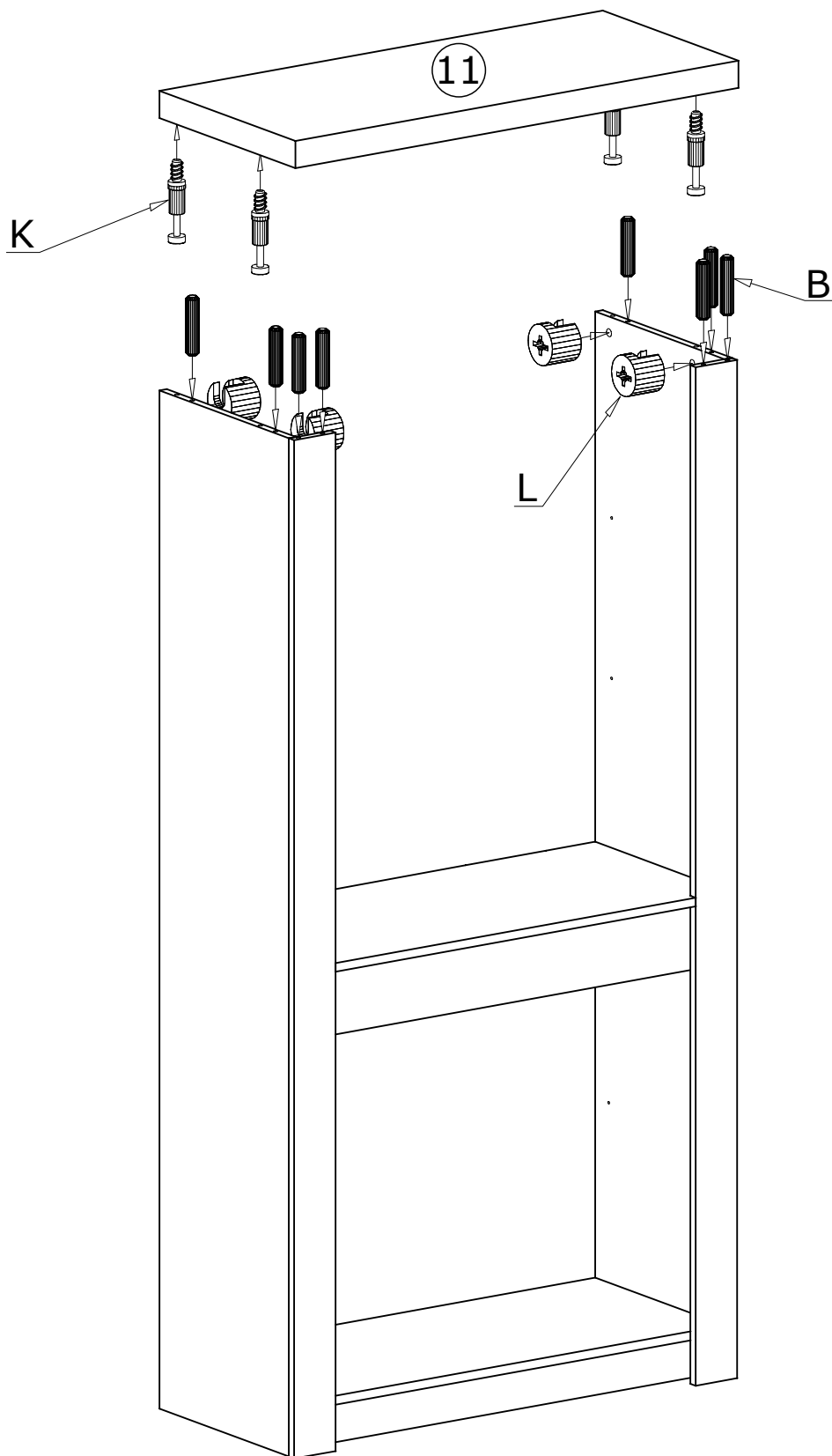

Meble zawierają elementy drewniane, których barwa i układ słoów są uzależnione od wielu czynników, dlatego mogą występować różnice w fakturze i barwie co nie stanowi wady produktu i nie wpływa na jego jakość, trwałość i funkcjonalność.

Listwy drewniane mogą ujawniać niewielkie zmiany w kształcie i wymiarach wywołane specyficznymi warunkami eksploatacji takimi jak: wilgotność, różnice temperatur, etc.

IV

50X 

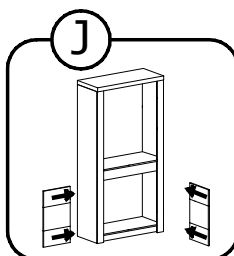
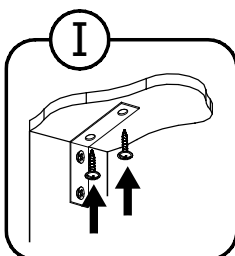
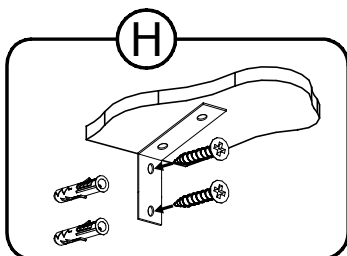
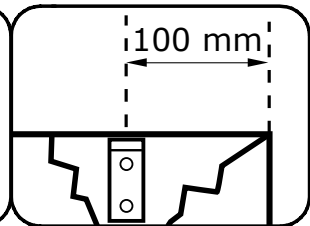
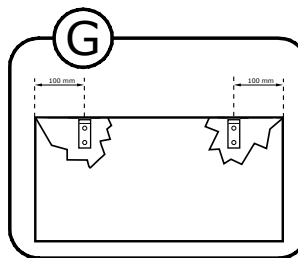
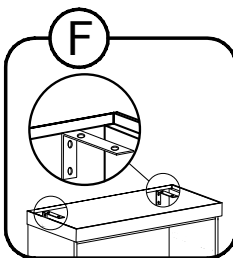
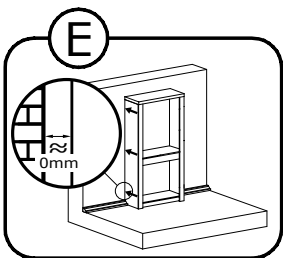
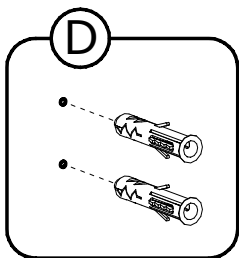
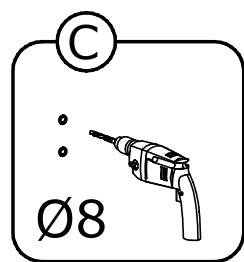
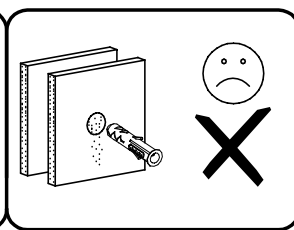
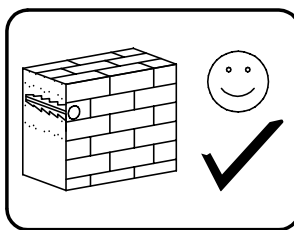
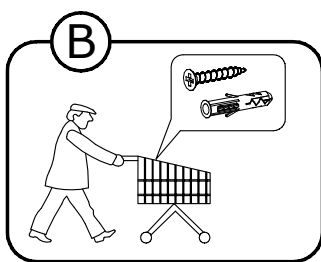
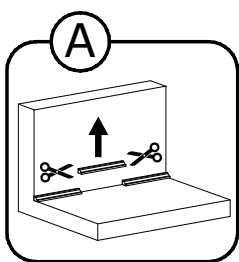
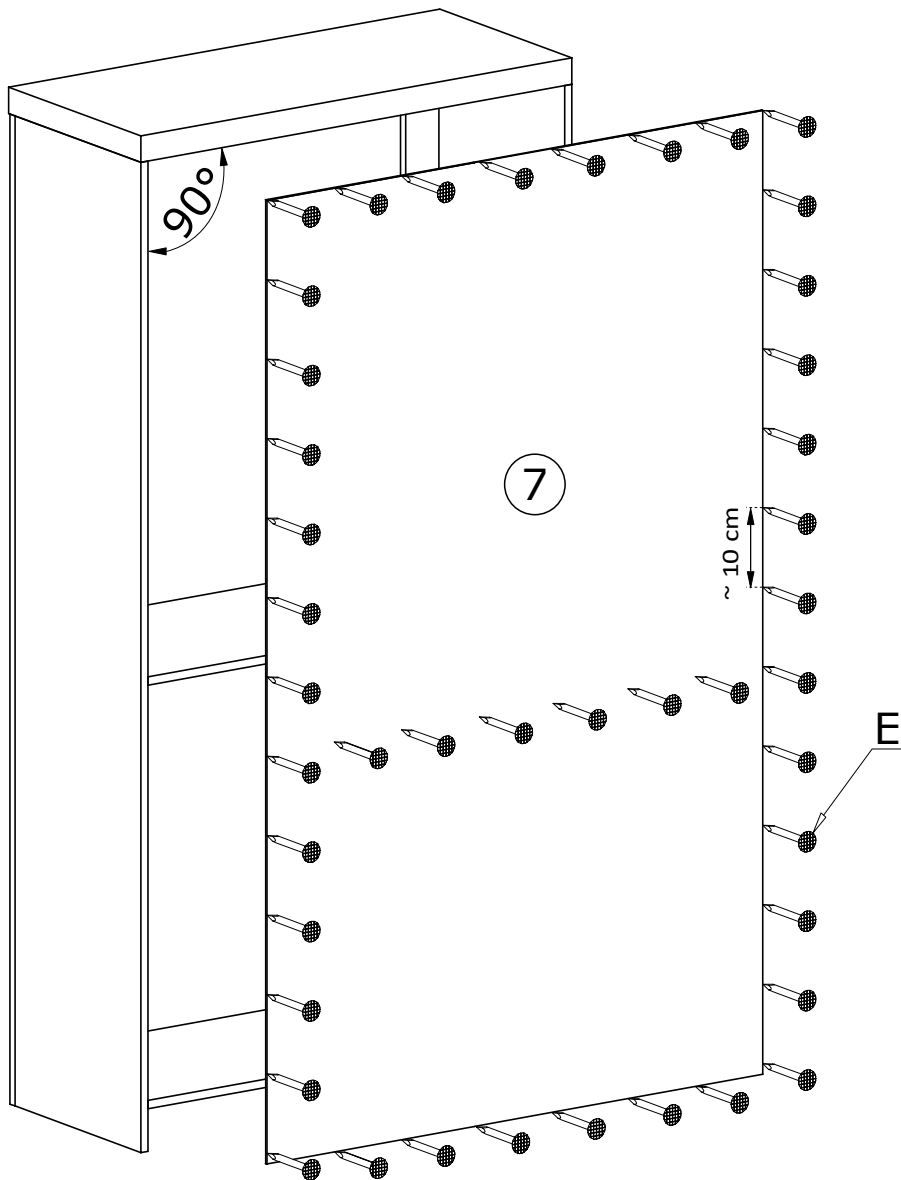

V

