

# DOUGLAS 20

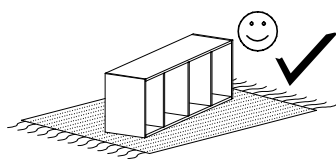

Narzędzia potrzebne do montażu

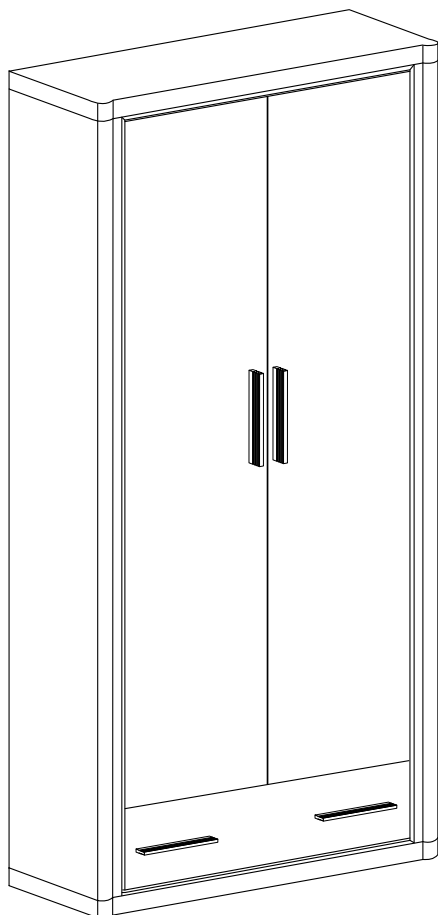

## UWAGA !!!

MONTOWANIE USZKODZONYCH  
ELEMENTÓW POWODUJE UTRATĘ  
GWARANCJI

Nr	D[mm]	S[mm]	G[mm]	Ilość
1	970	590	48	1
2	970	590	48	1
3	930	25	16	2
4	1810	562	16	1
5	1810	562	16	1
6	1810	100	32	1
7	1810	100	32	1
8	545	200	16	1
9	545	200	16	1
10	935	545	16	1
11	1835	960	2,5	1
12	770	190	16	1
13	500	150	16	1
14	500	150	16	1
15	695	150	16	1
16	723	505	2,5	1
17	1620	380	16	2
18	935	80	16	1

W przypadku reklamacji proszę podać numer pakowacza znajdujący się na kartonie.

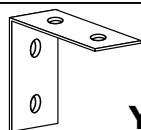

**Y - 1 St.**

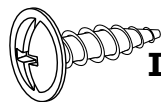

**I - 2 St.**  
3,5x16 mm



**X1 - 22 St.**



**X2 - 6 St.**

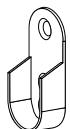

**P - 2 St.**

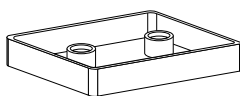

**A - 4 St.**

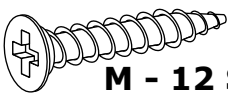

**M - 12 St.**  
3,9x25 mm

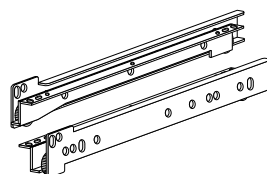

**T - 1 Kpl.**



**O - 1 St.**

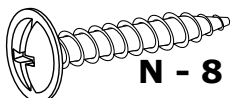

**N - 8 St.**  
4x27 mm

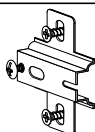

**C - 6 St.**

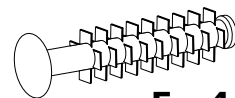

**F - 4 St.**

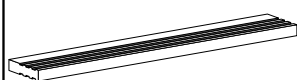

**U - 4 St.**

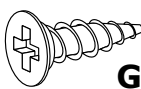

**G - 20 St.**  
3,5x16 mm

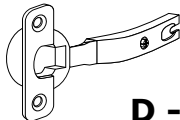

**D - 6 St.**

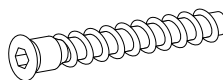

**W - 6 St.**

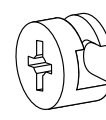

**L - 22 St.**



**E - 80 St.**



**B - 26 St.**

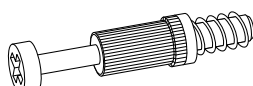

**K - 22 St.**

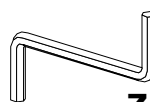

**Z - 1 St.**

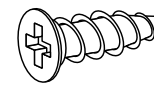

**J - 4 St.**  
5x13 mm

I

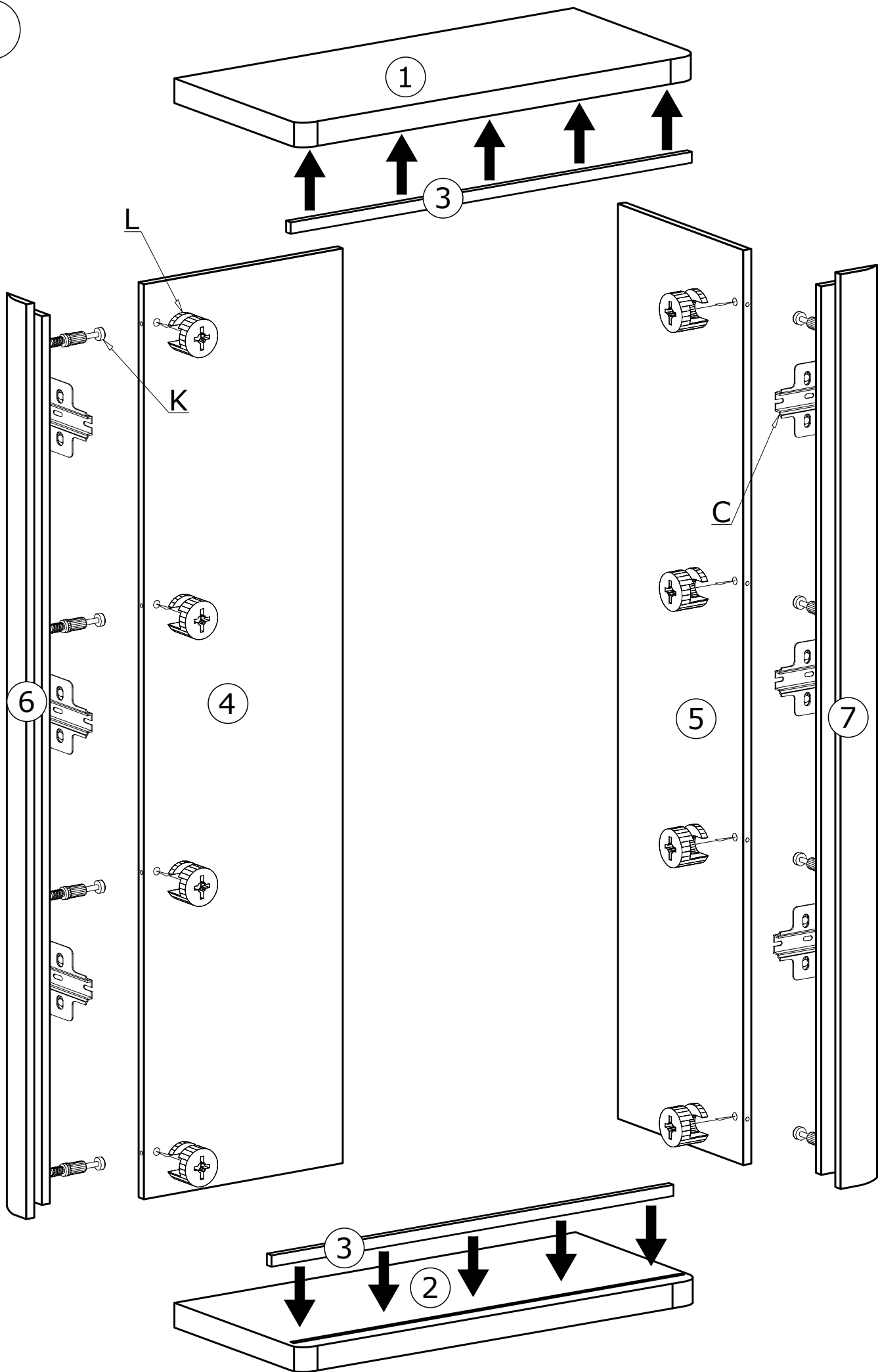

II

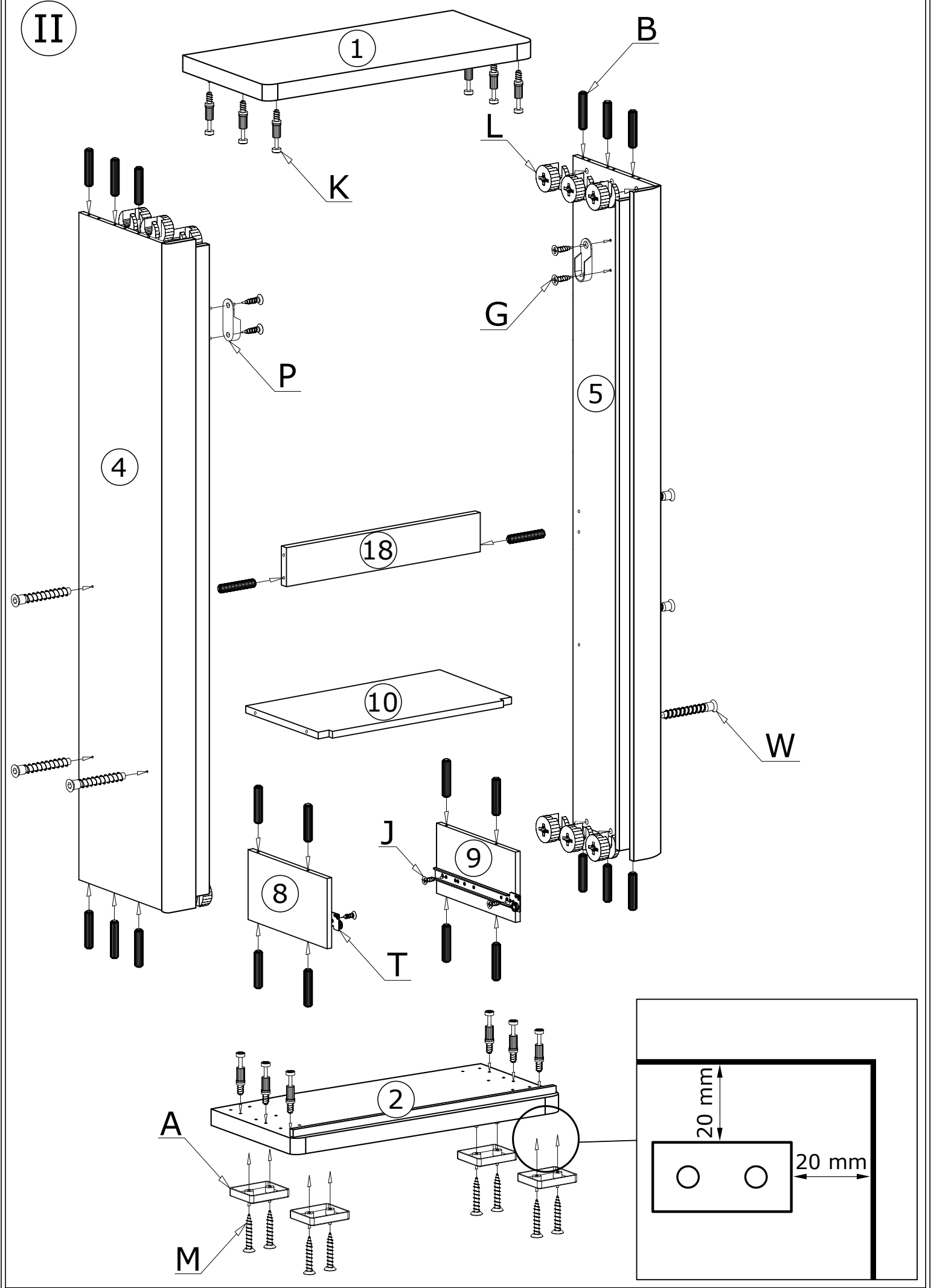

III

80X

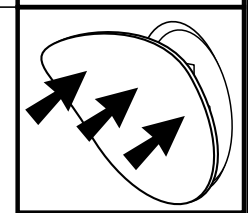
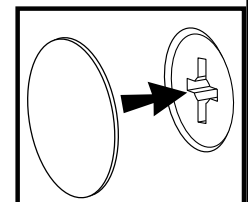
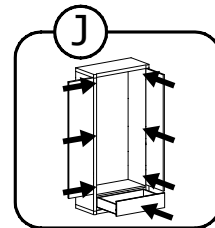
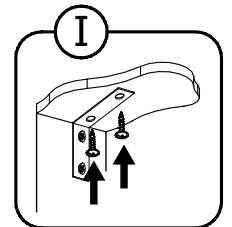
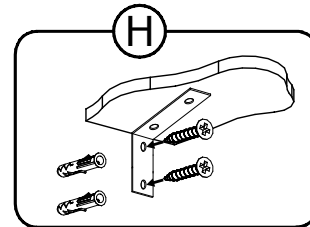
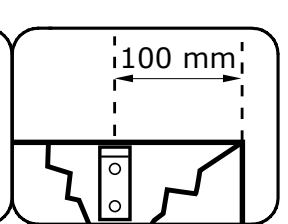
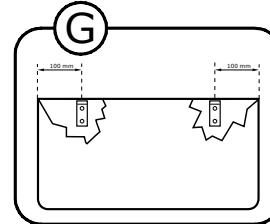
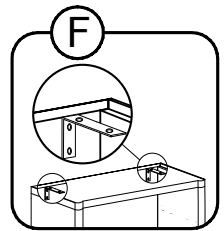
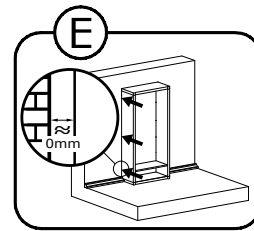
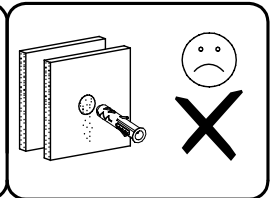
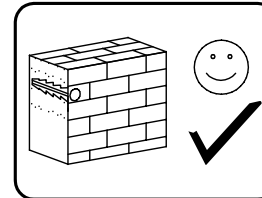
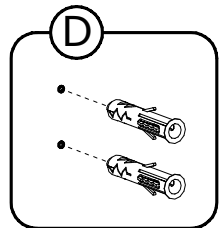
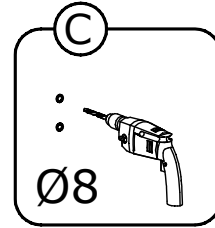
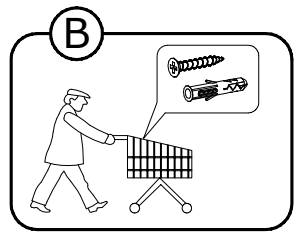
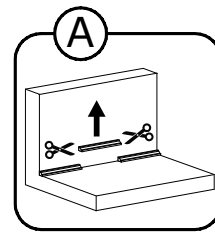

IV

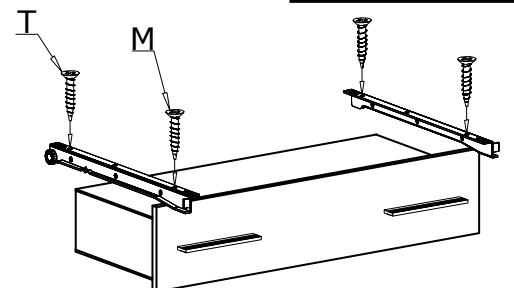
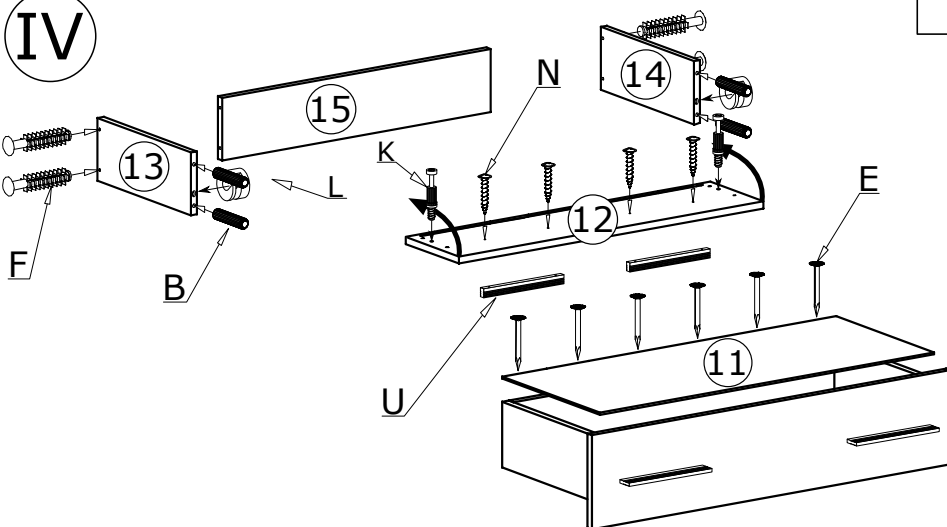

V

