

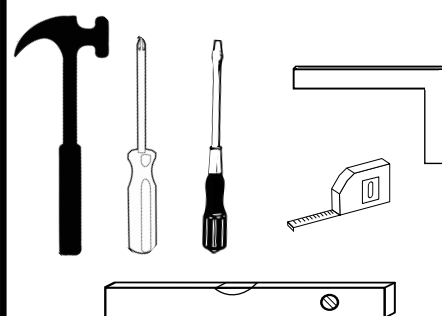

# DESAYUNO VES

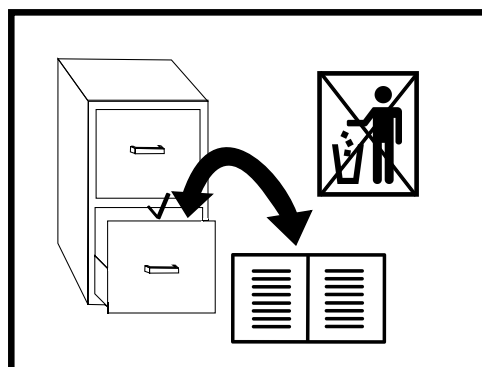

INSTRUKCJA MONTAŻU • ASSEMBLY INSTRUCTION • MONTAGEANLEITUNG

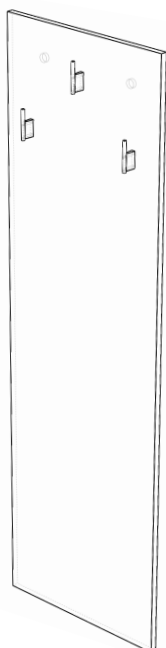

PL

Czyszczenie należy wykonywać wyłącznie za pomocą ściereczki lub lekko nawilżonego ręcznika. Nie stosować środków czyszczących do szorowania.

Formularz reklamacyjny znajduje się na ostatniej stronie instrukcji montażu.



GB

Please only clean with a duster or a damp cloth. Do not use any abrasive cleaners.

The complaint form is on the last page.



DE

Bitte nur mit einem Staubtuch oder leicht feuchtem Lappen reinigen. Keine scheuerenden Putzmittel verwenden.

Das Beschwerdeformular befindet sich auf der letzten Seite.



CZ

Očistěte pouze hadříkem nebo mírně navlhčeným ručníkem. Nepoužívejte abrazivní čisticí prostředky.

Formulář stížnosti je na poslední stránce.



SK

Očistite ho handričkou alebo mierne navlhčenou handričkou. Nepoužívajte abrazívne čistiace prostriedky.

Formulár sťažnosti je na poslednej strane.





HU

Tiszta egy ruhával vagy kissé megnedvesített törölközővel.

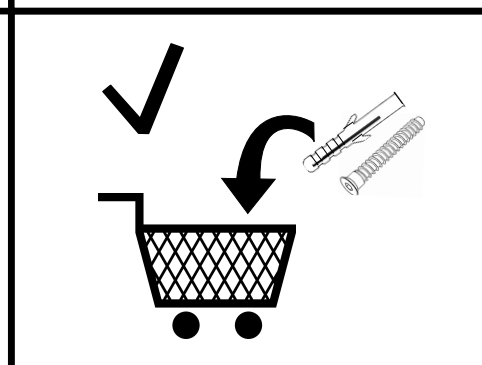
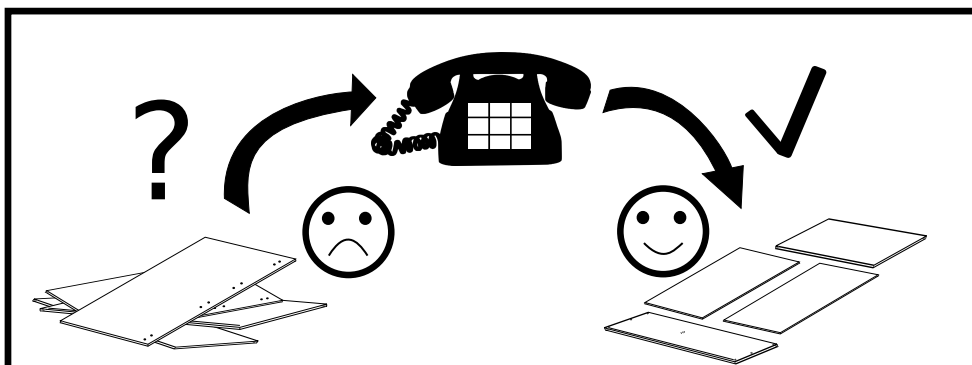
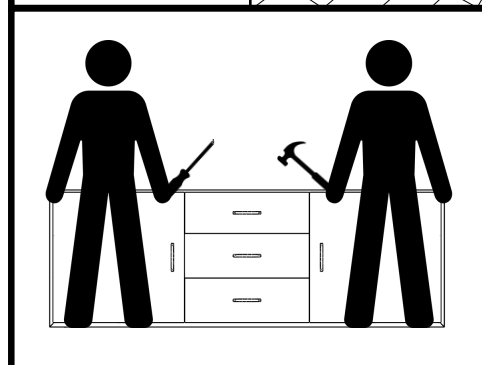
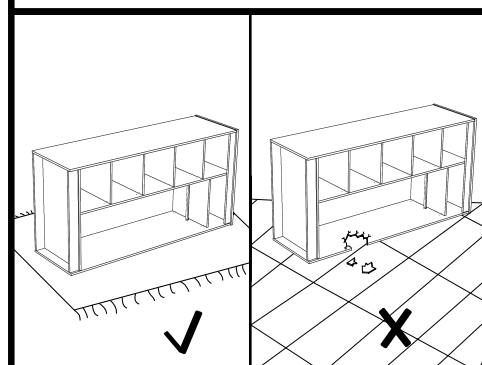
A panaszos úrlap megtalálható az utolsó oldalon.

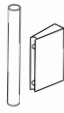

# Akcesoria • Accessories • Zubehör

6	3	2
		
J1	i	Y

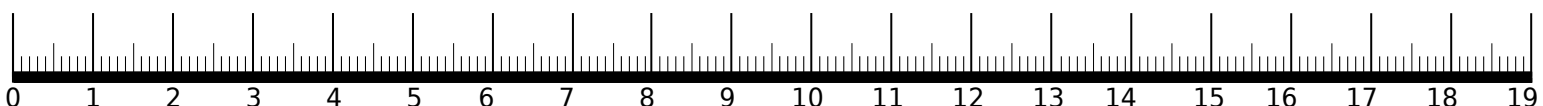
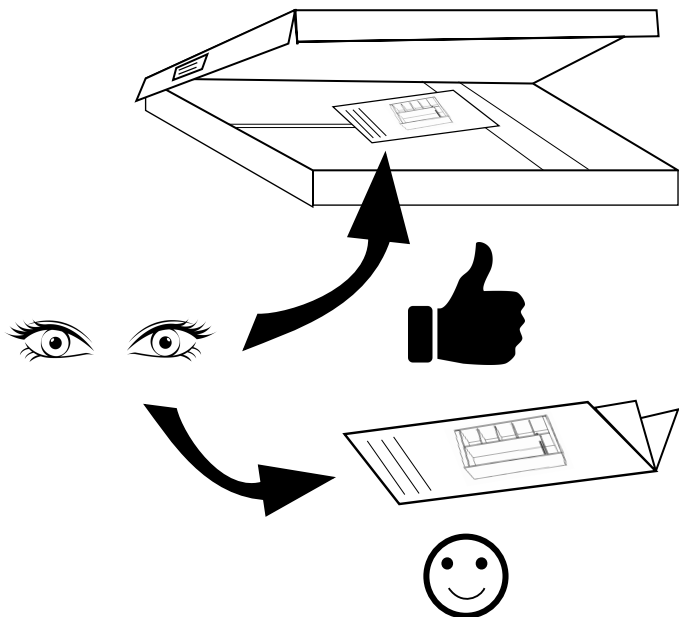
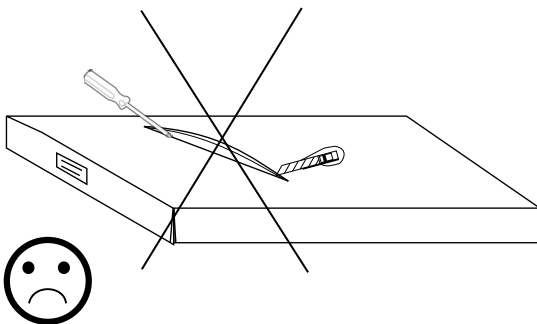
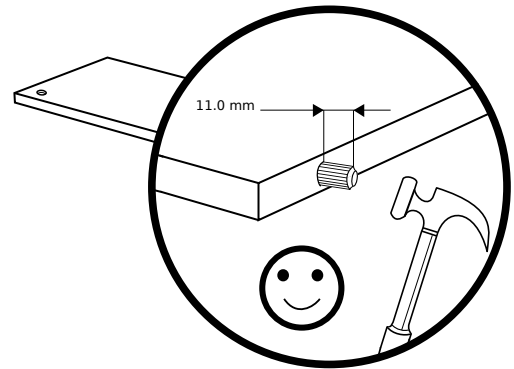
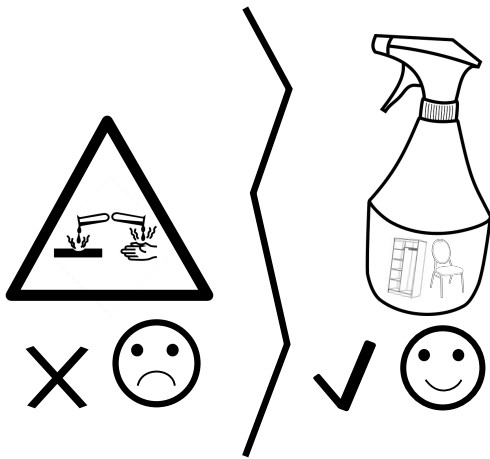
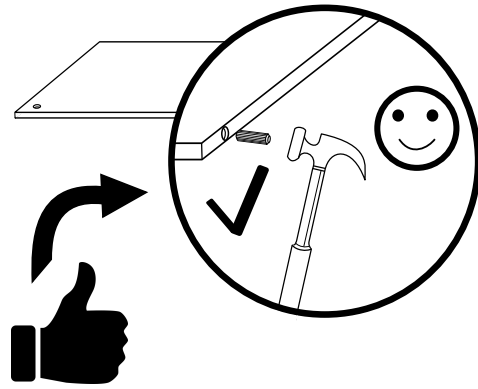
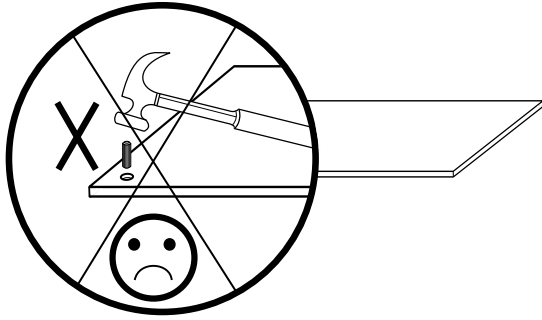

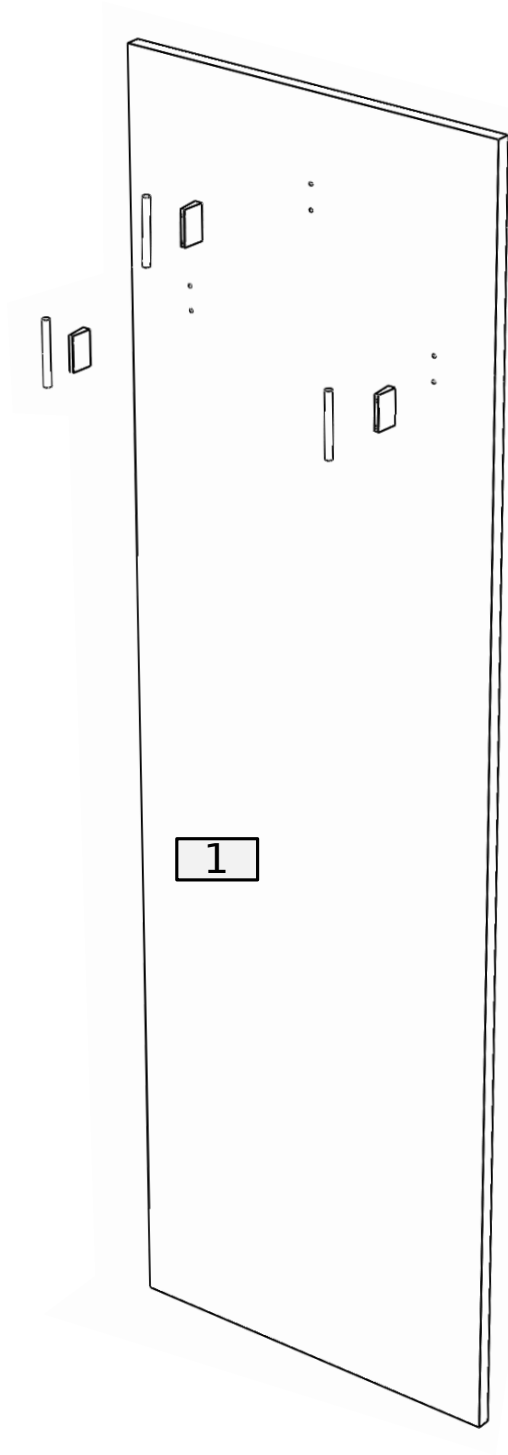

No.	Pcs.	L	W	T	Pac
1	1	1500	465	16	1/1

①

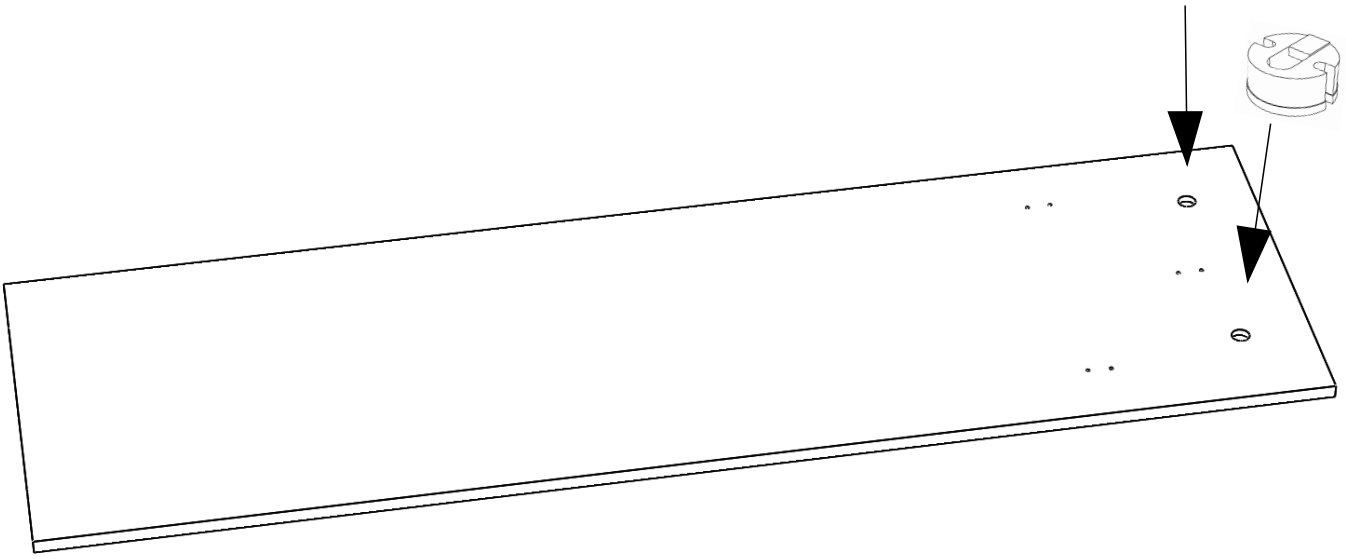
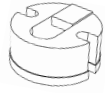
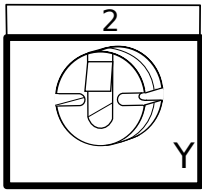

②

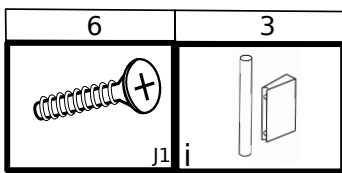
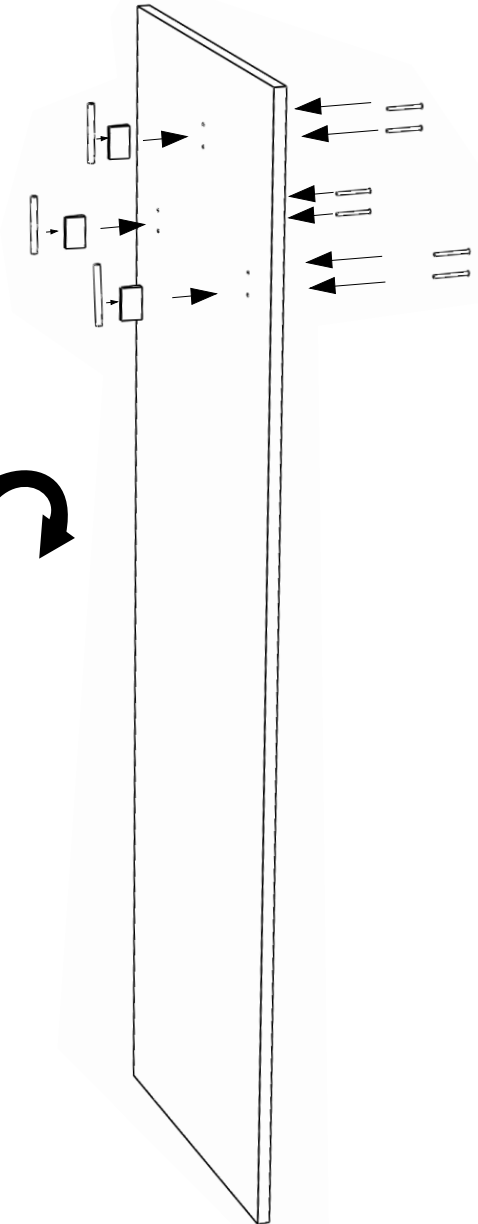

3

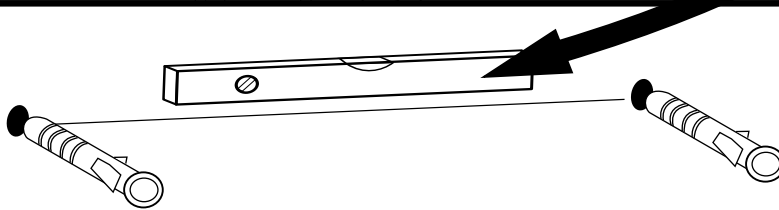
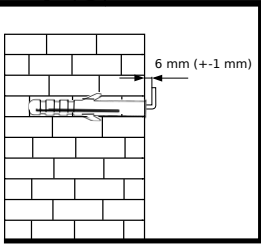
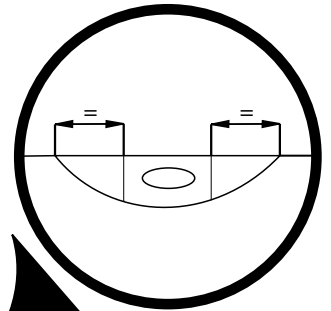
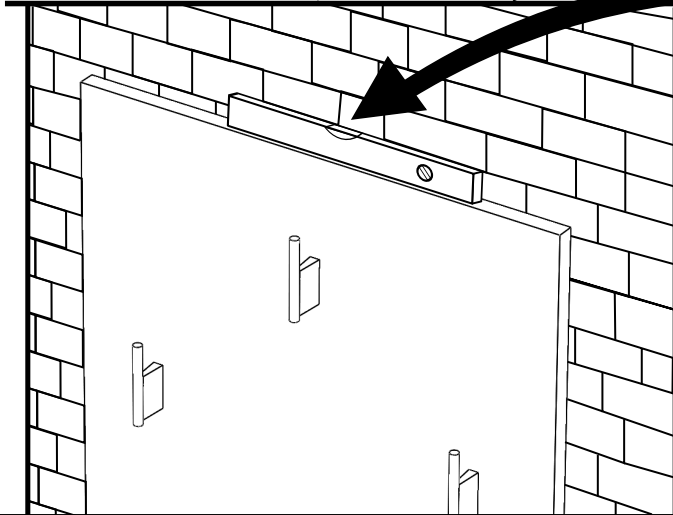
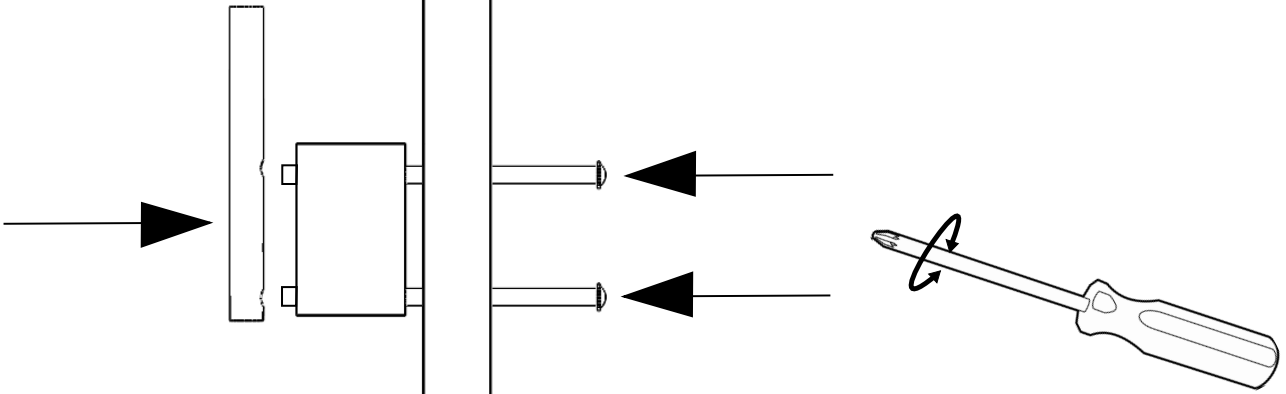

Formularz reklamacyjny • Complaint Form • Beschwerdeformular



- Zaznacz brakujący lub uszkodzony element.
- Mark the missing or damaged element.
- Markieren Sie das fehlenden oder beschädigten element.

**Monastery/czarny|Biały/Biały połysk|Biały/Grafit połysk**

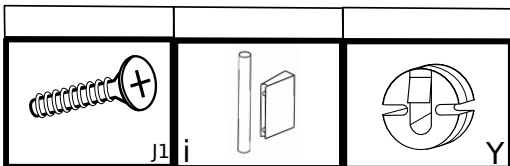
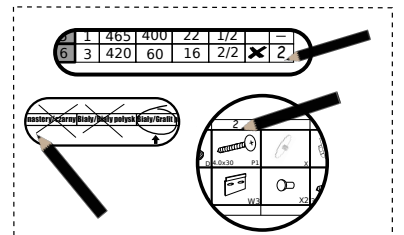

No.	Pcs.	L	W	T	Pac	
1	1	1500	465	16	1/1	X

**DENVER Wieszak**