

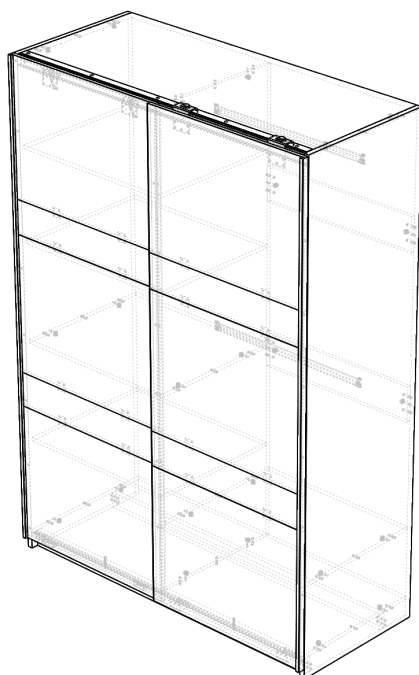

DESAYUNO DSZ150



INSTRUKCJA MONTAŻU • ASSEMBLY INSTRUCTION • MONTAGEANLEITUNG



PL

Czyszczenie należy wykonywać wyłącznie za pomocą ściereczki lub lekko nawilżonego ręcznika. Nie stosować środków czyszczących do szorowania.

Formularz reklamacyjny znajduje się na ostatniej stronie instrukcji montażu.



GB

Please only clean with a duster or a damp cloth. Do not use any abrasive cleaners.

The complaint form is on the last page.



DE

Bitte nur mit einem Staubtuch oder leicht feuchtem Lappen reinigen. Keine scheuernden Putzmittel verwenden.

Das Beschwerdeformular befindet sich auf der letzten Seite.



CZ

Očistěte pouze hadříkem nebo mírně navlhčeným ručníkem. Nepoužívejte abrazivní čisticí prostředky.

Formulář stížnosti je na poslední stránce.



SK

Očistite ho handričkou alebo mierne navlhčenou handričkou. Nepoužívajte abrazívne čistiace prostriedky.

Formulár sťažnosti je na poslednej strane.



HU

Tiszta egy ruhával vagy kissé megnedvesített törölközővel.

A panaszos úrlap megtalálható az utolsó oldalon.

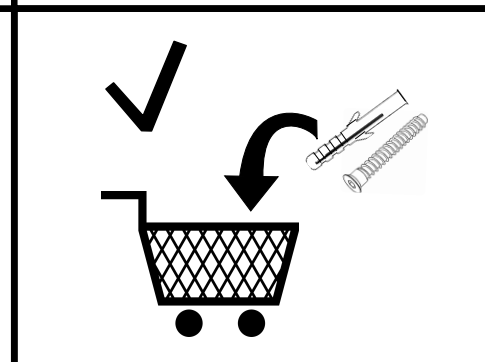
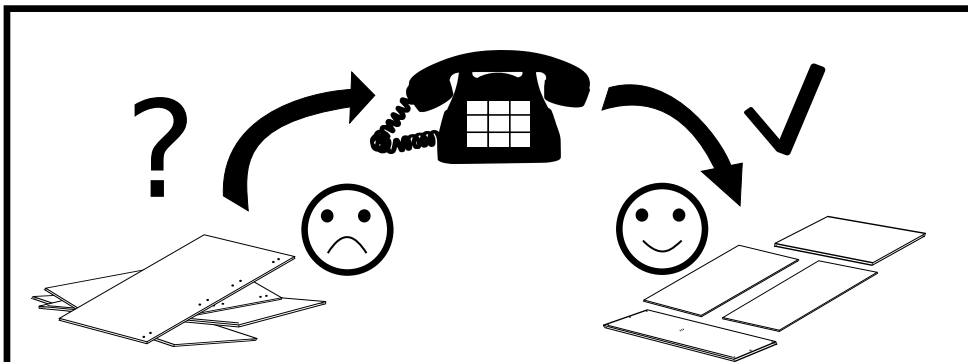
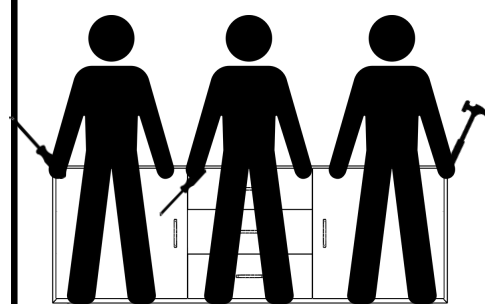
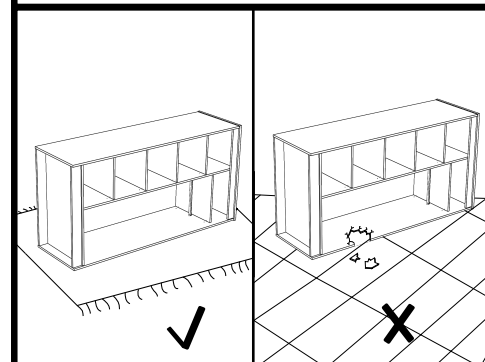
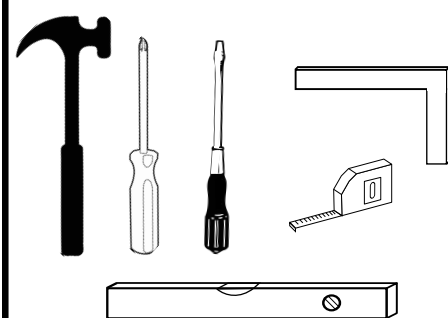
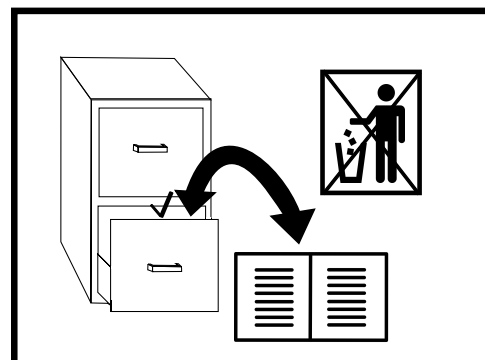

Akcesoria • Accessories • Zubehör

24	24	46	24	4	4	12	1	20	2	2	2
B	A 8.0x35	D	X	X3	O	S3	Q	G2	D1	D2	WL
L-713	N2 3.5x16	W2 3.0x16	W3 3.0x16	W5 3.5x25	W5 G	D3	D4	D5	R3	F 6.3x13	H1
2	4	36	5	4	84	1	1	2	16	89	2

1454	1454	1454	1454
T1	T2	T3	T4
1	1	2	2

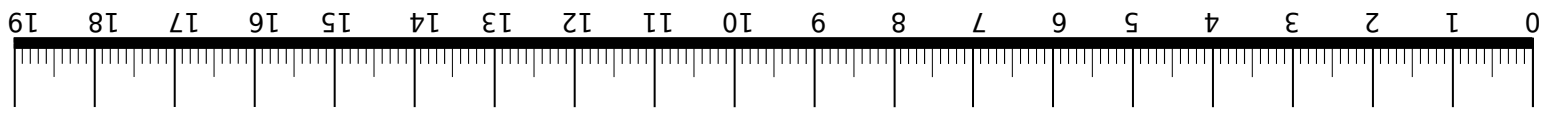
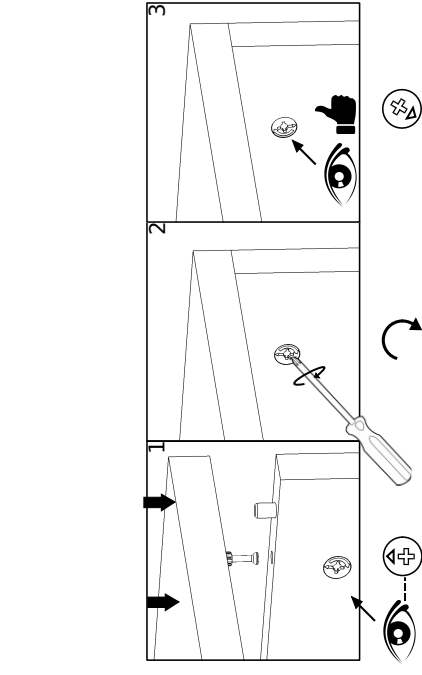
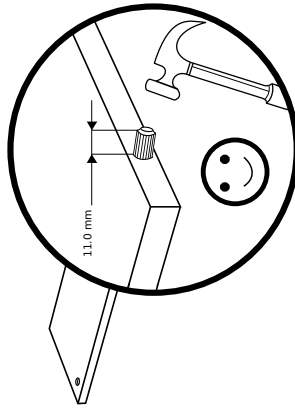
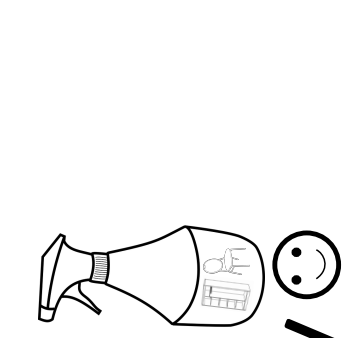
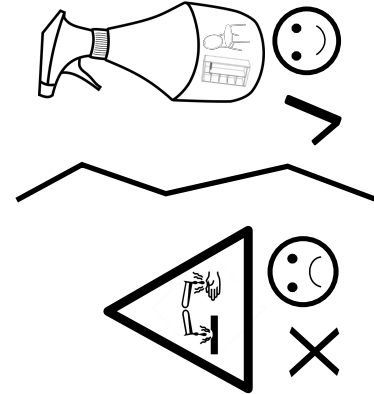
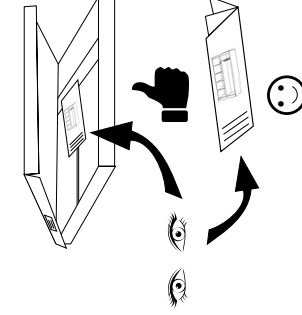
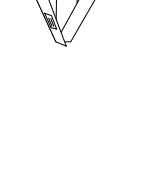
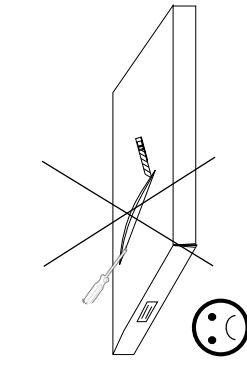
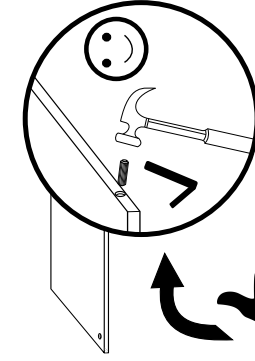
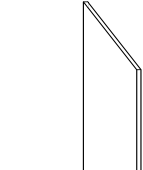
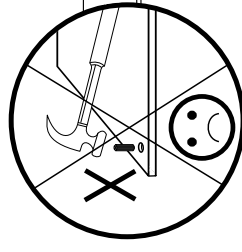

No.	Pcs.	L	W	D	Pac
1	1	1456	606	22	3/6
2	1	1456	617	16	3/6
3	1	2150	622	22	1/6
4	1	2042	603	16	2/6
5	1	2150	650	22	1/6
6	2	720	603	16	2/6
7	2	720	150	16	4/6
8	2	1456	70	22	3/6
9	2	2067	742	3	2/6
10	3	720	603	16	4/6

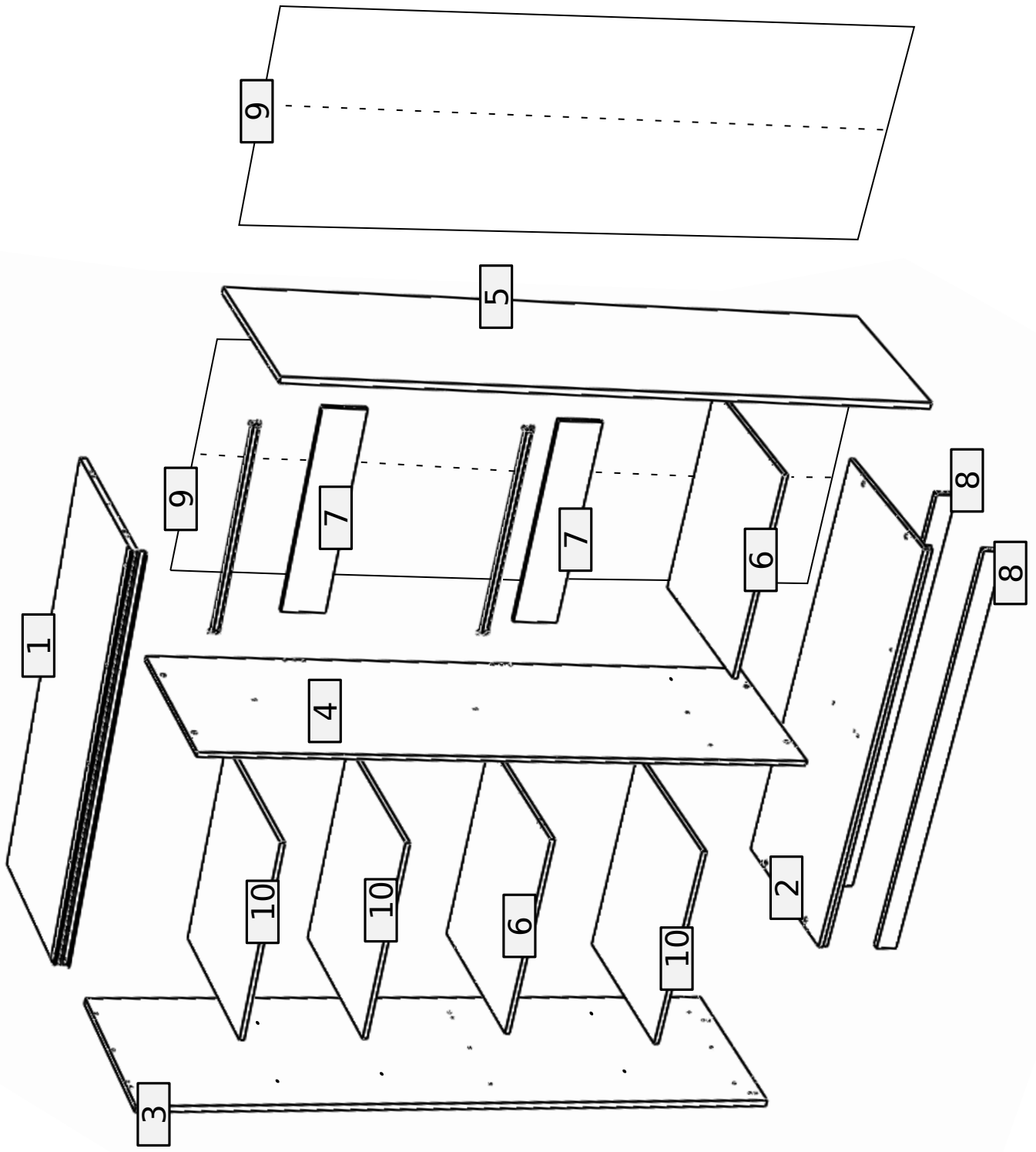

1

1	2	6
WL 3.5x25	W5	S3

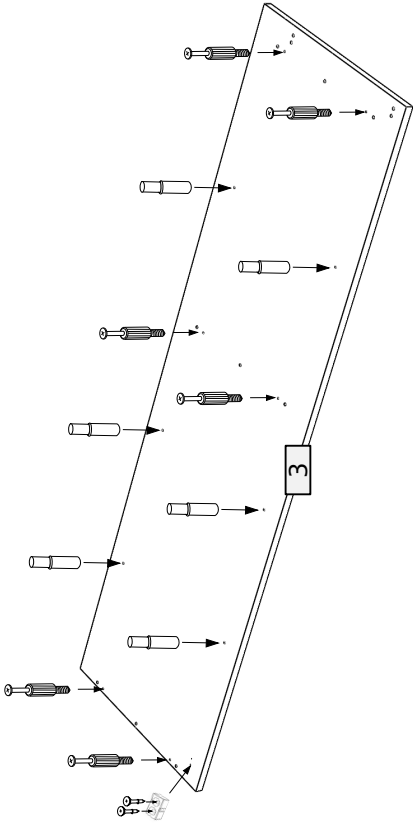

2

1	2	8
WL 3.5x25	W5	A

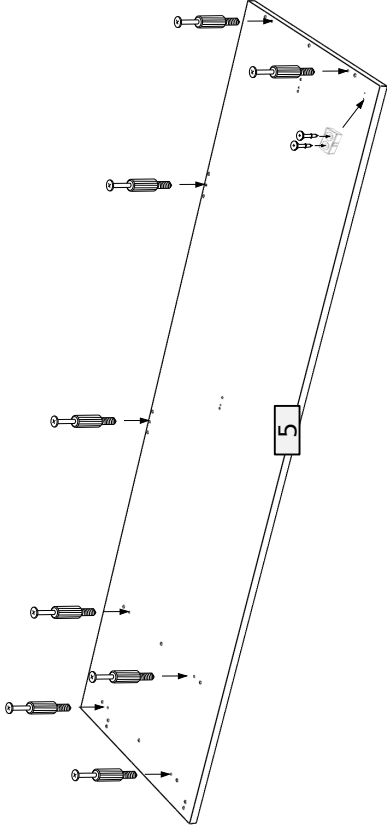

3

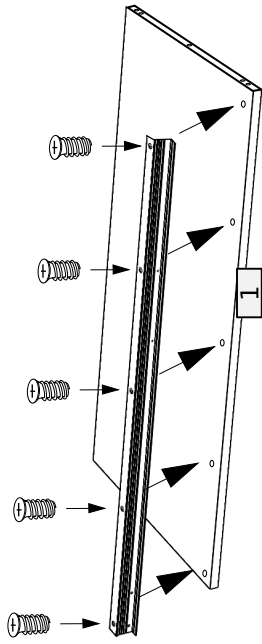

4

4	6	6
B 6.0x35	D	A

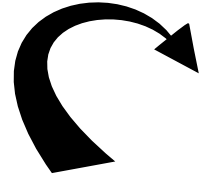
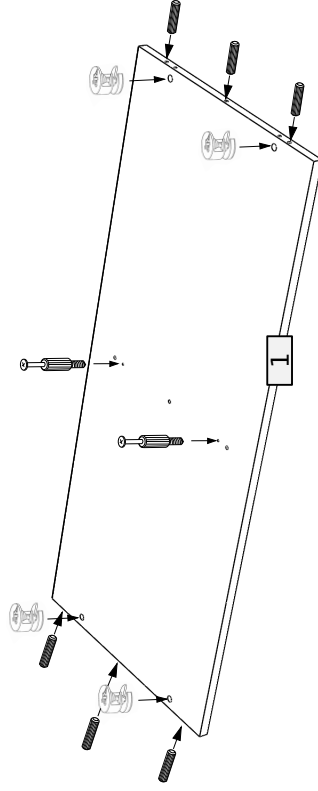

T2	I	5	F

5

6	D	6.0x35
6	S3	
2	A	

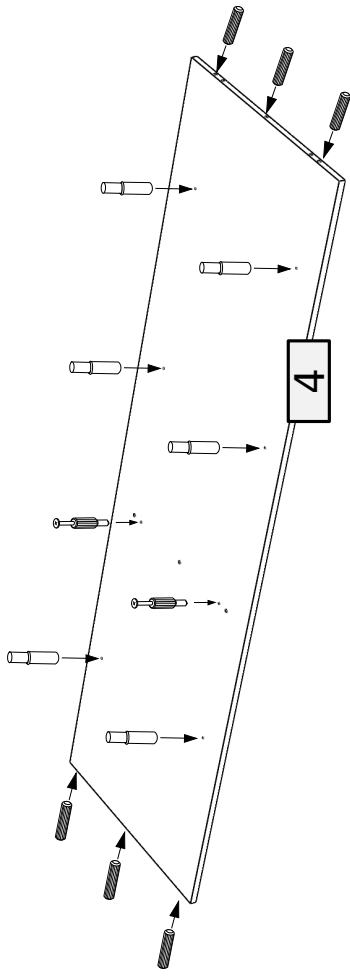

6

4	B	
4	A	

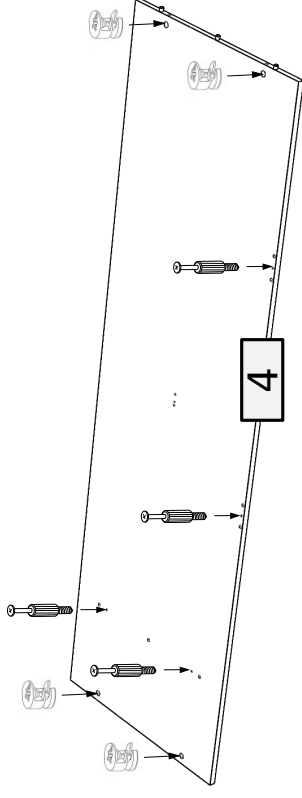

7

4	B	
2	A	6.0x35
6	D	

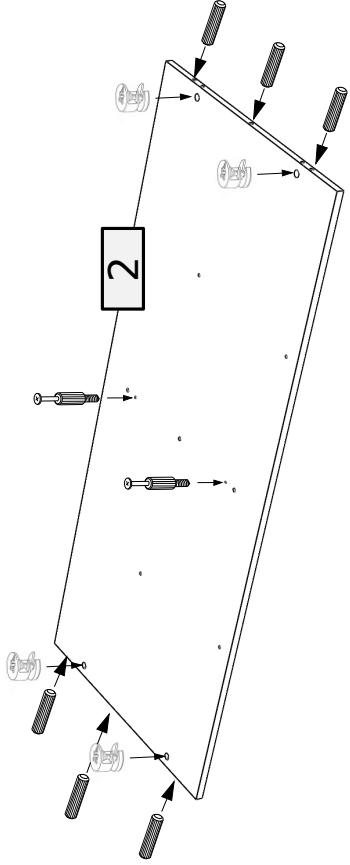

8 x 2

4	D	6.0x35
---	---	--------

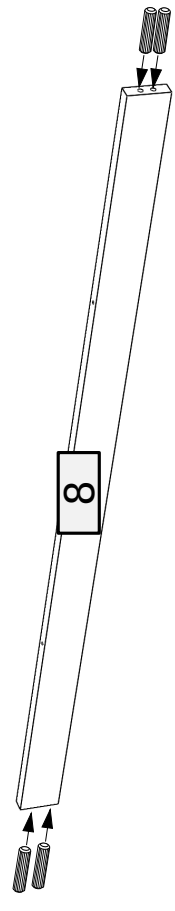

⑨ x2

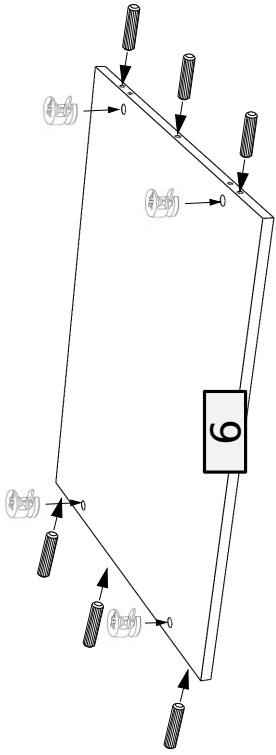
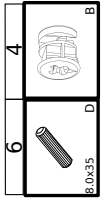

⑩ x2

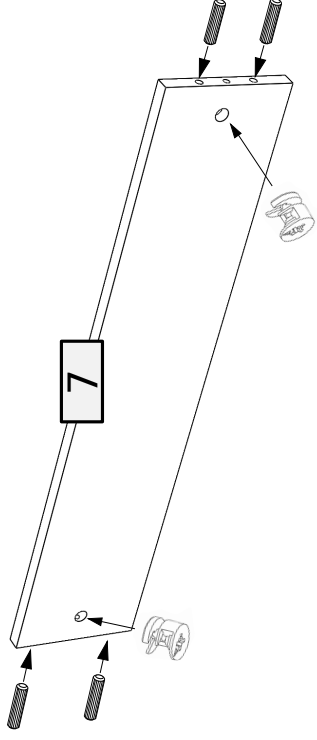
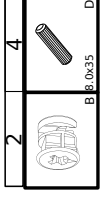

⑪

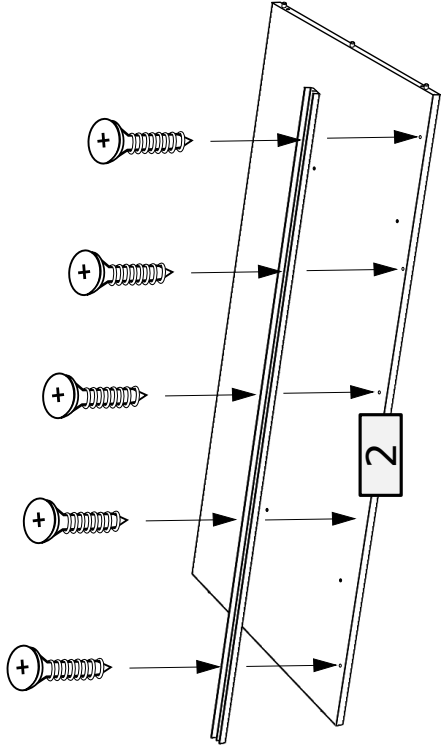
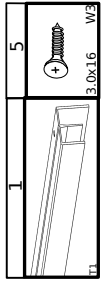

⑫

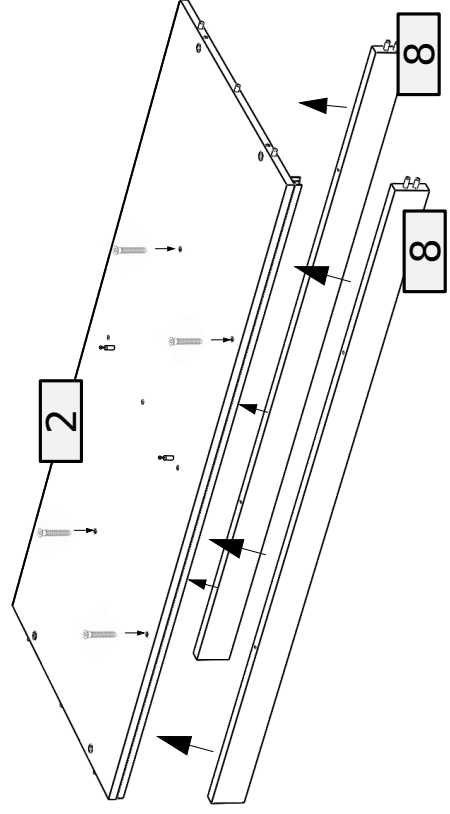
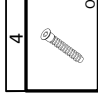
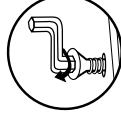

13

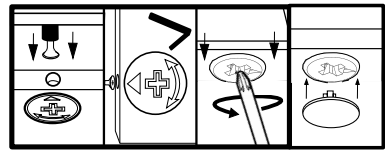
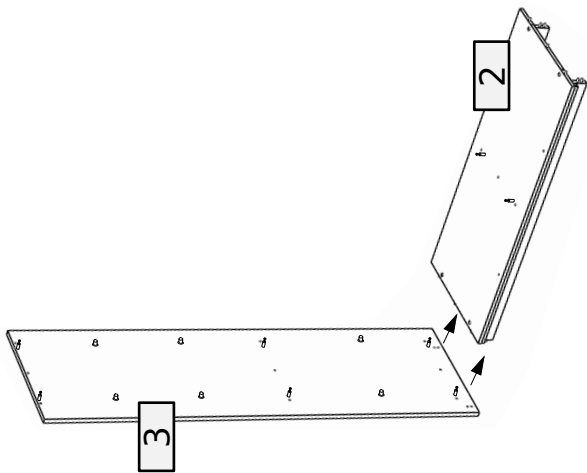

14

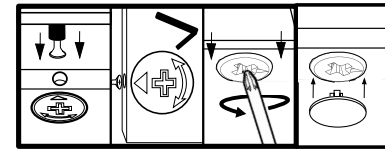
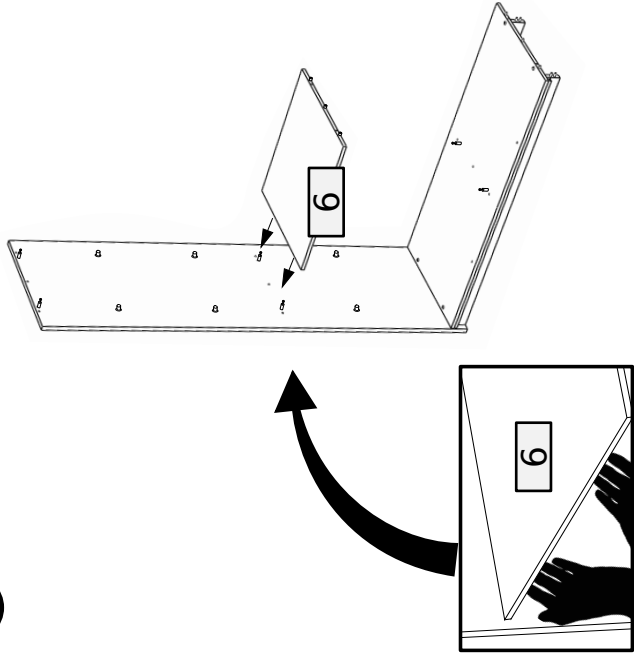

15

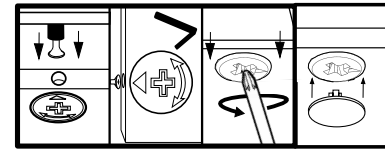
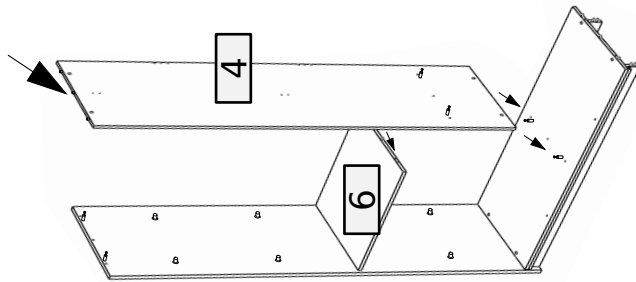

16

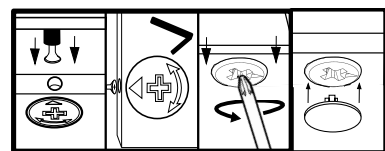
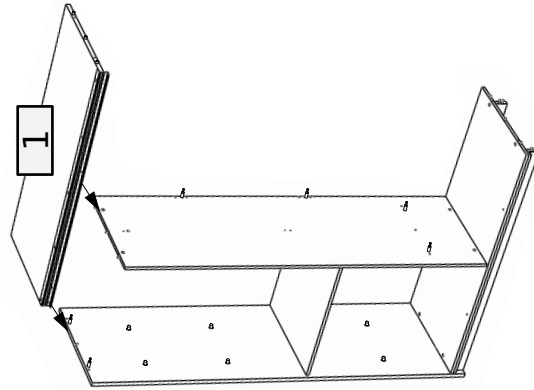

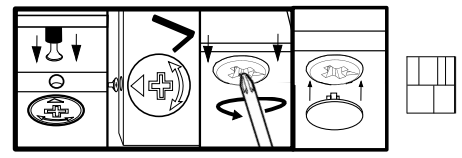

17

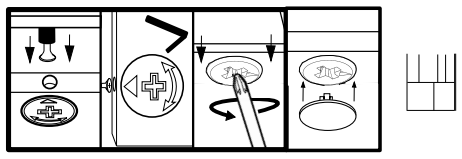

18

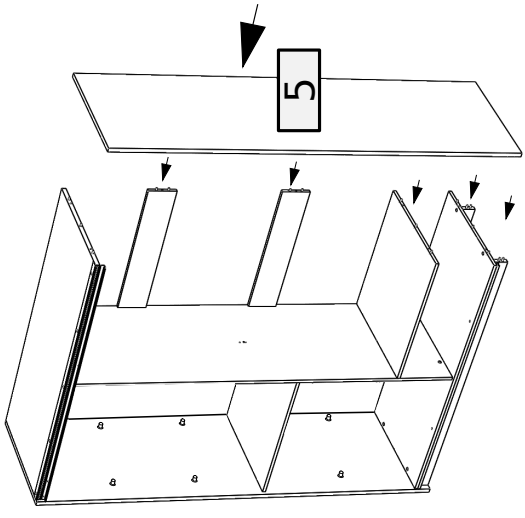
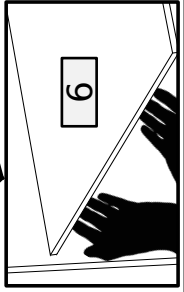
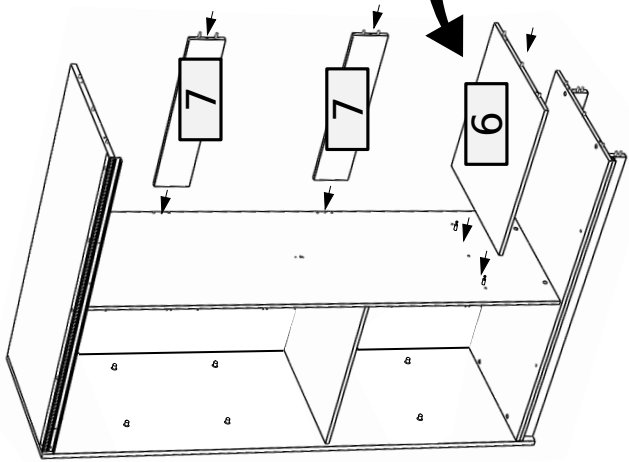

19

20

20		G2
G		84

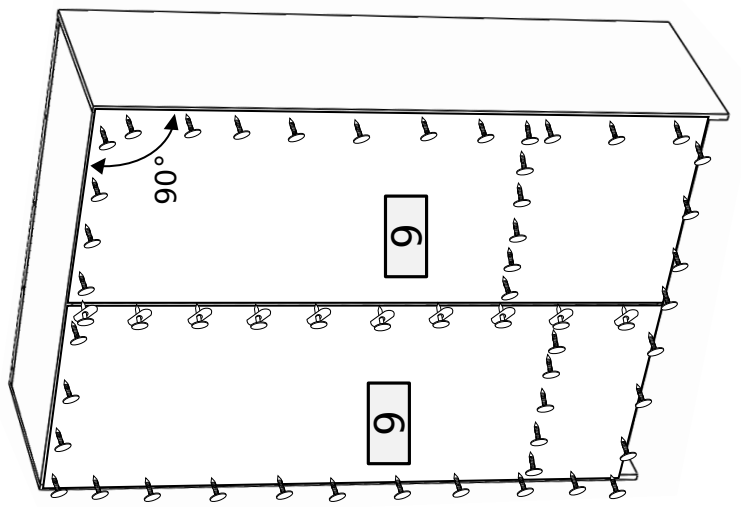

	3.5x16	4
	W2	4
N2		4

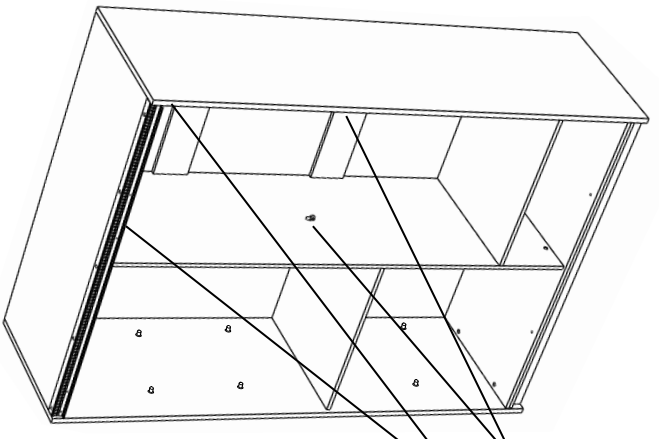
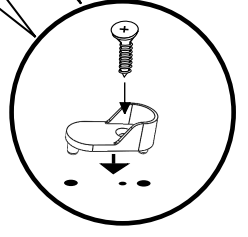

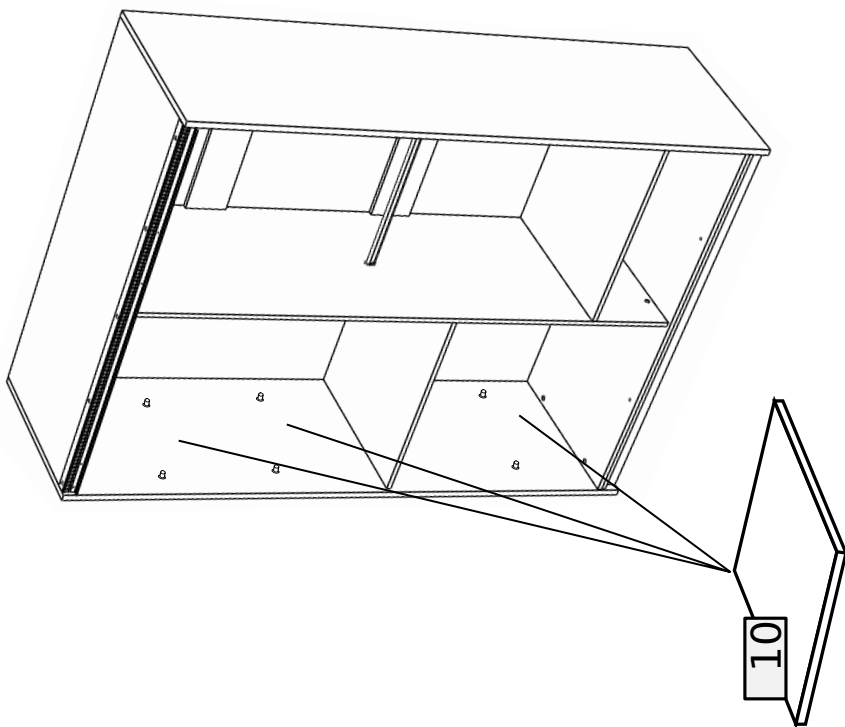

21

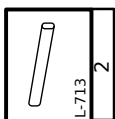
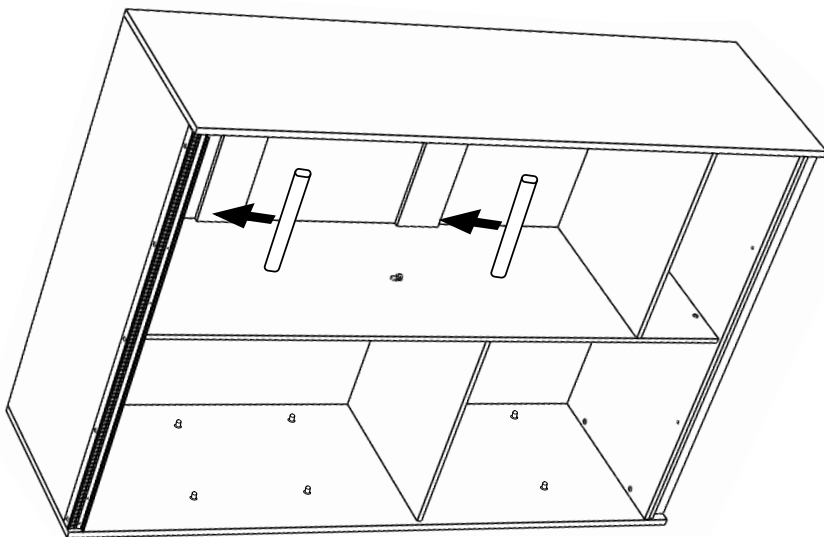

20

No.	Pcs.	L	W	T	T(połysk)	Pac
11						
12						
13						
14						

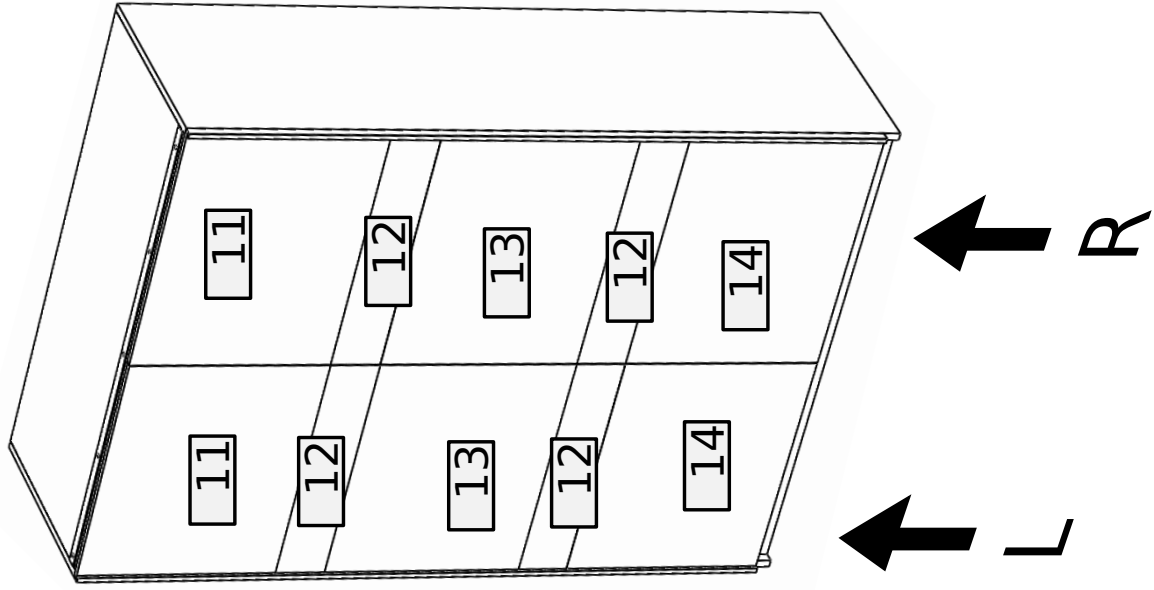

22 x2

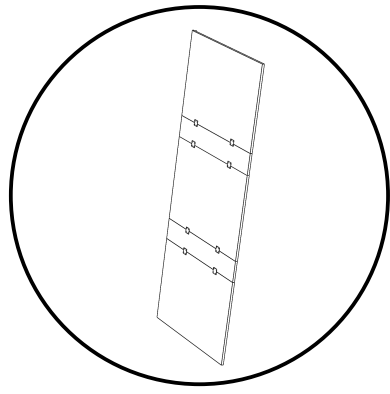
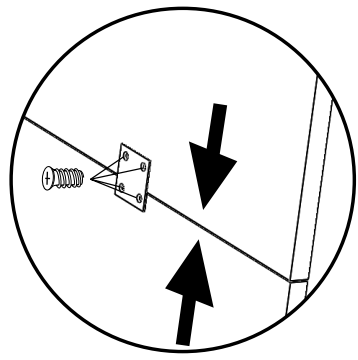
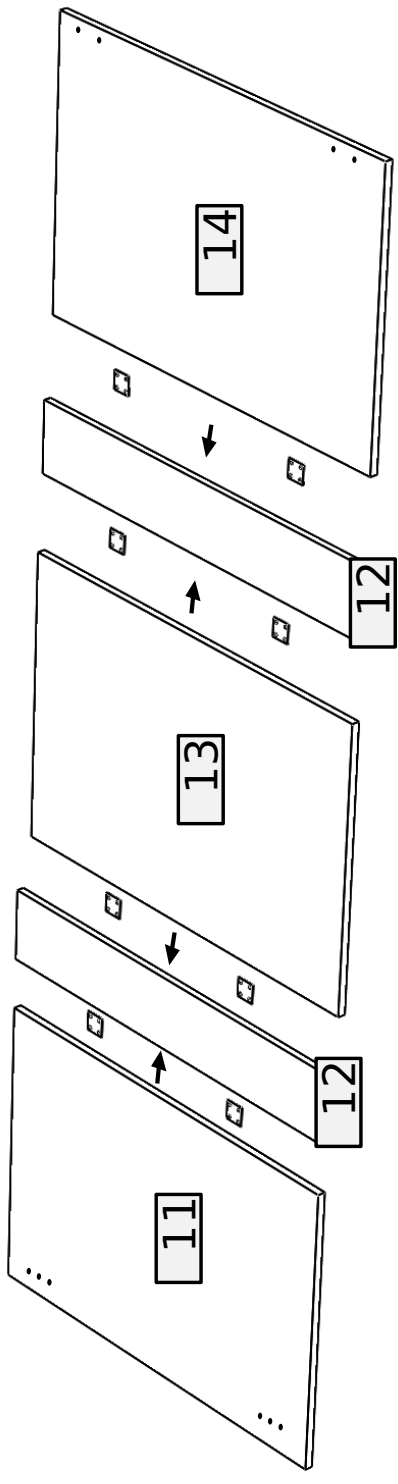

32	8
6.3x13	R3

F



23

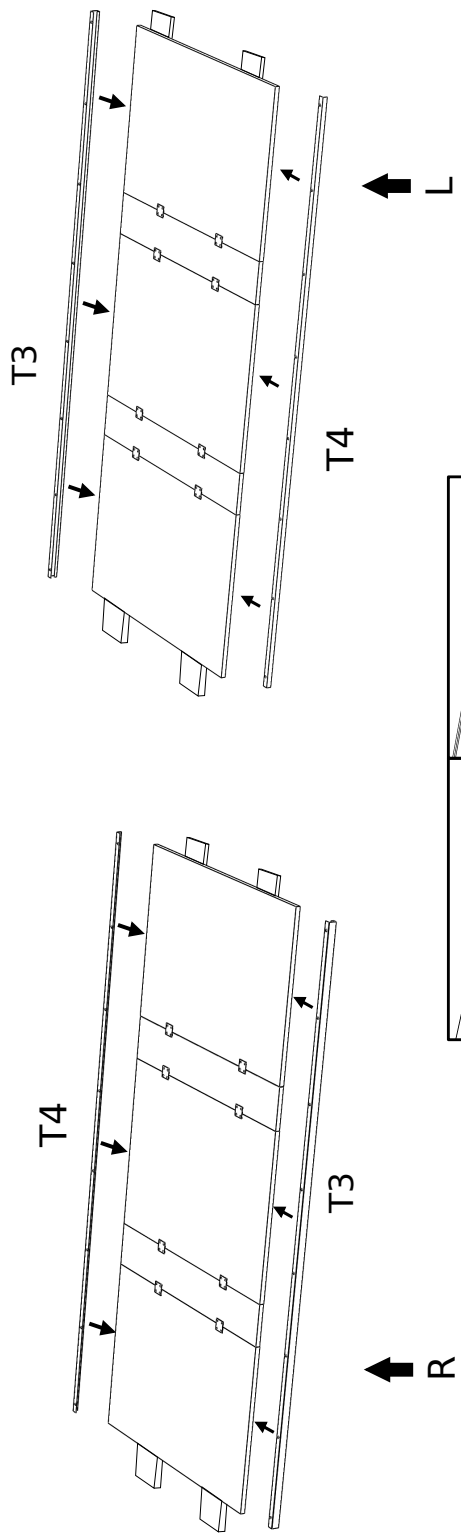

R

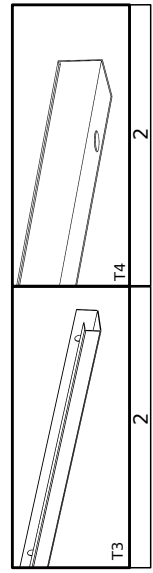

24 x2

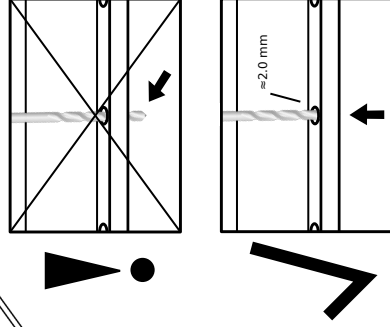
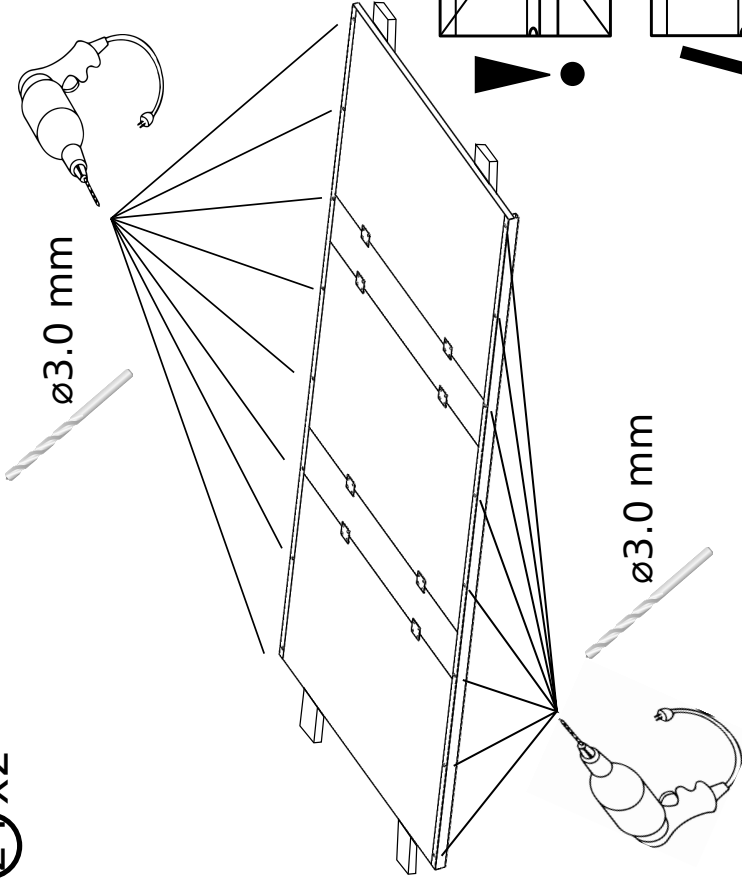

25 x2

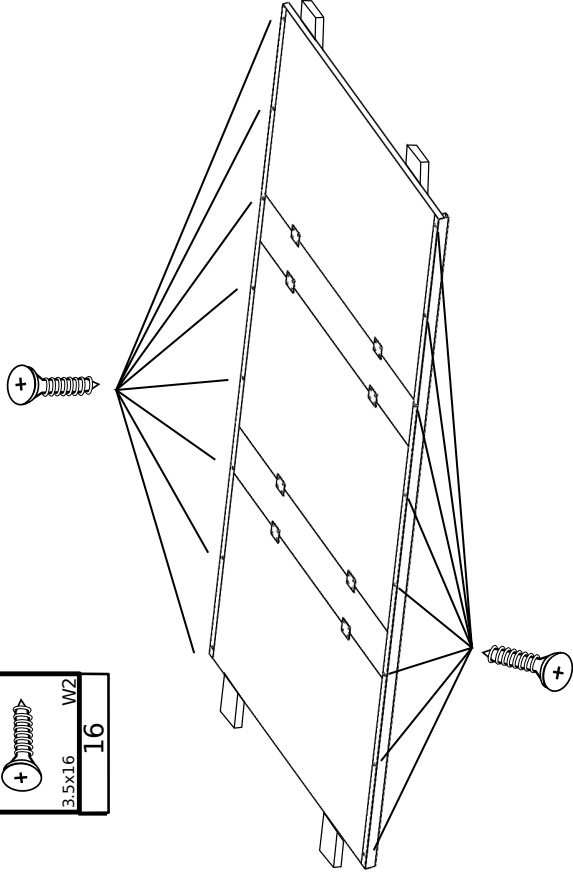
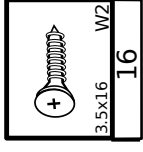

26

	F	20		D1	2		D2	2		D3	1		D4	1		D5	2
6.3x13																	

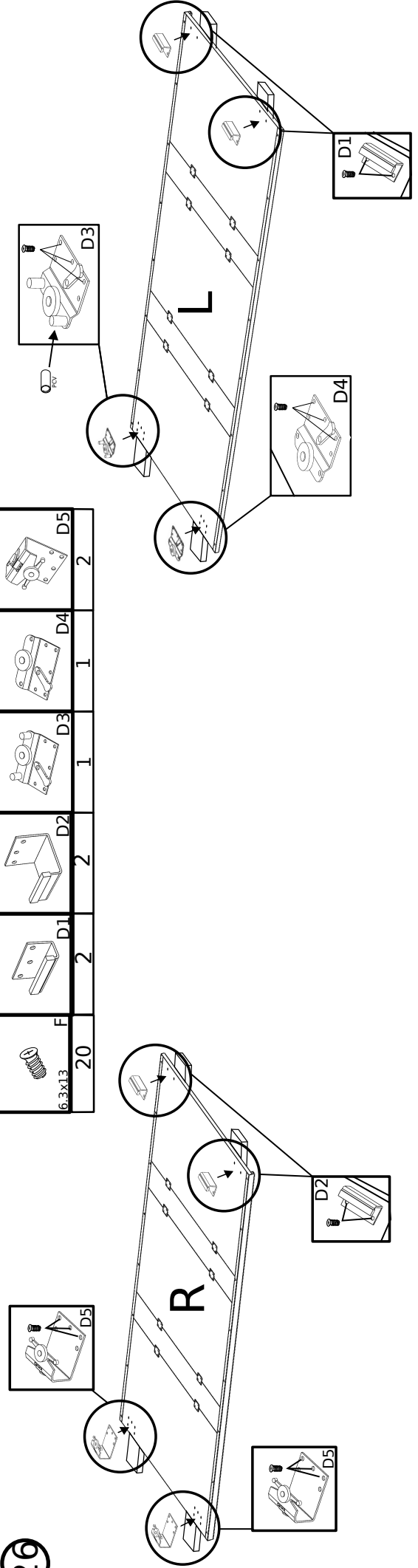

27

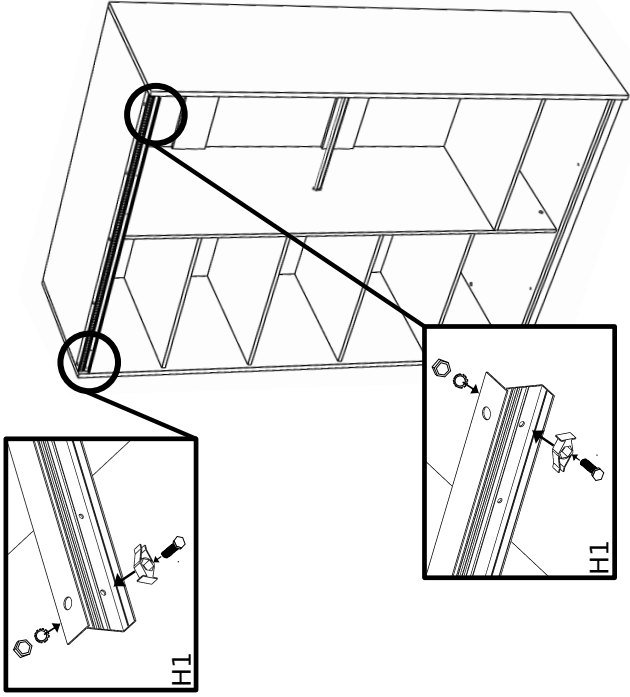

2	2	+	W2
2	H1	3.5x16	



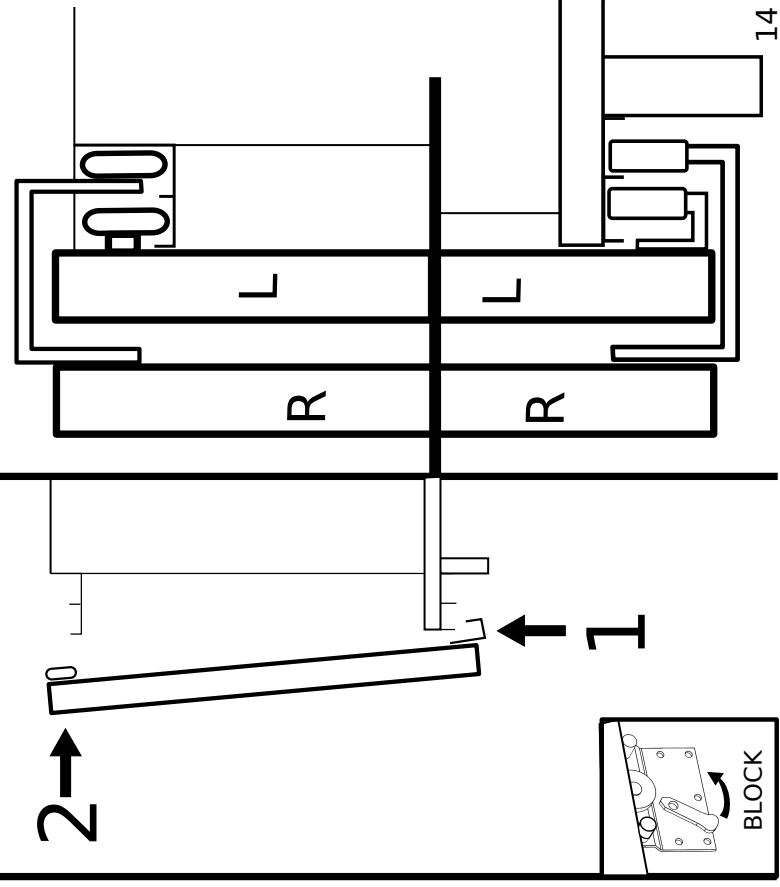
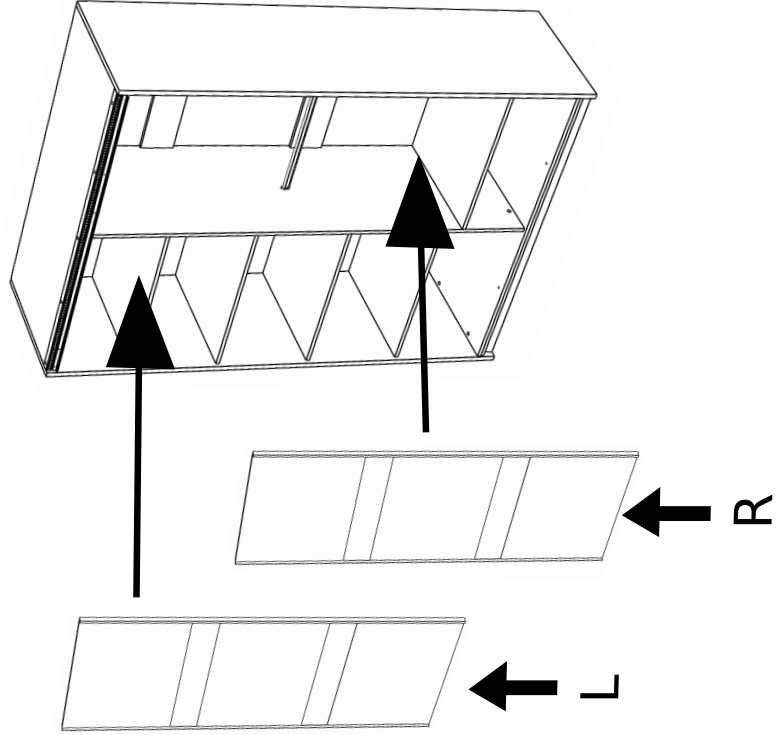















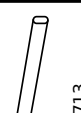
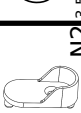

28



Formularz reklamacyjny • Complaint Form • Beschwerdeformular



- Zaznacz brakujący lub uszkodzony element.
- Mark the missing or damaged element.
- Markieren Sie das fehlenden oder beschädigten element.

										
										
L-713	N2 3.5x16	W2 3.0x16	W3 3.0x16	W5G 3.5x25	D3	D4	D5	R3 6.3x13	F	H1

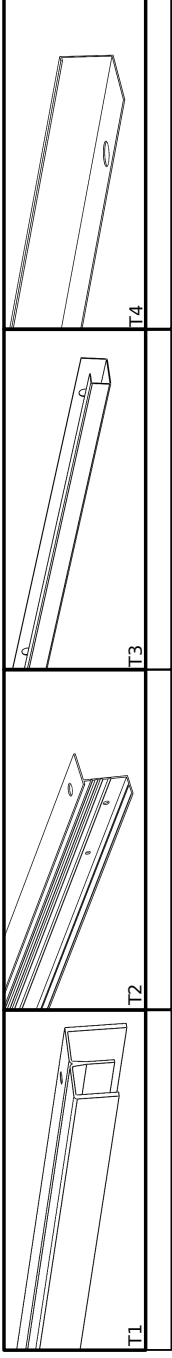

No.	Pcs.	L	W	D	Pac
1	1	1456	606	22	3/6
2	1	1456	617	16	3/6
3	1	2150	622	22	1/6
4	1	2042	603	16	2/6
5	1	2150	650	22	1/6
6	2	720	603	16	2/6
7	2	720	150	16	4/6
8	2	1456	70	22	3/6
9	2	2067	742	3	2/6
10	3	720	603	16	4/6

No.	Pcs.	L	W	T	T (polysk)	Pac
11	2	770	600	16	-	5/6
12	4	770	149	-	15	6/6
13	2	770	600	16	-	5/6
14	2	770	600	16	-	5/6

