

SN 108 S42 W41 G33

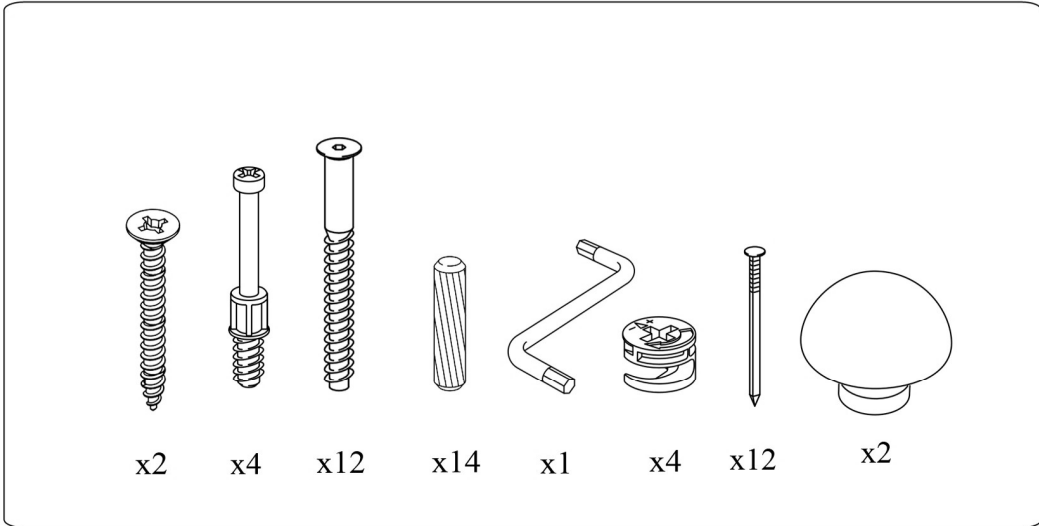

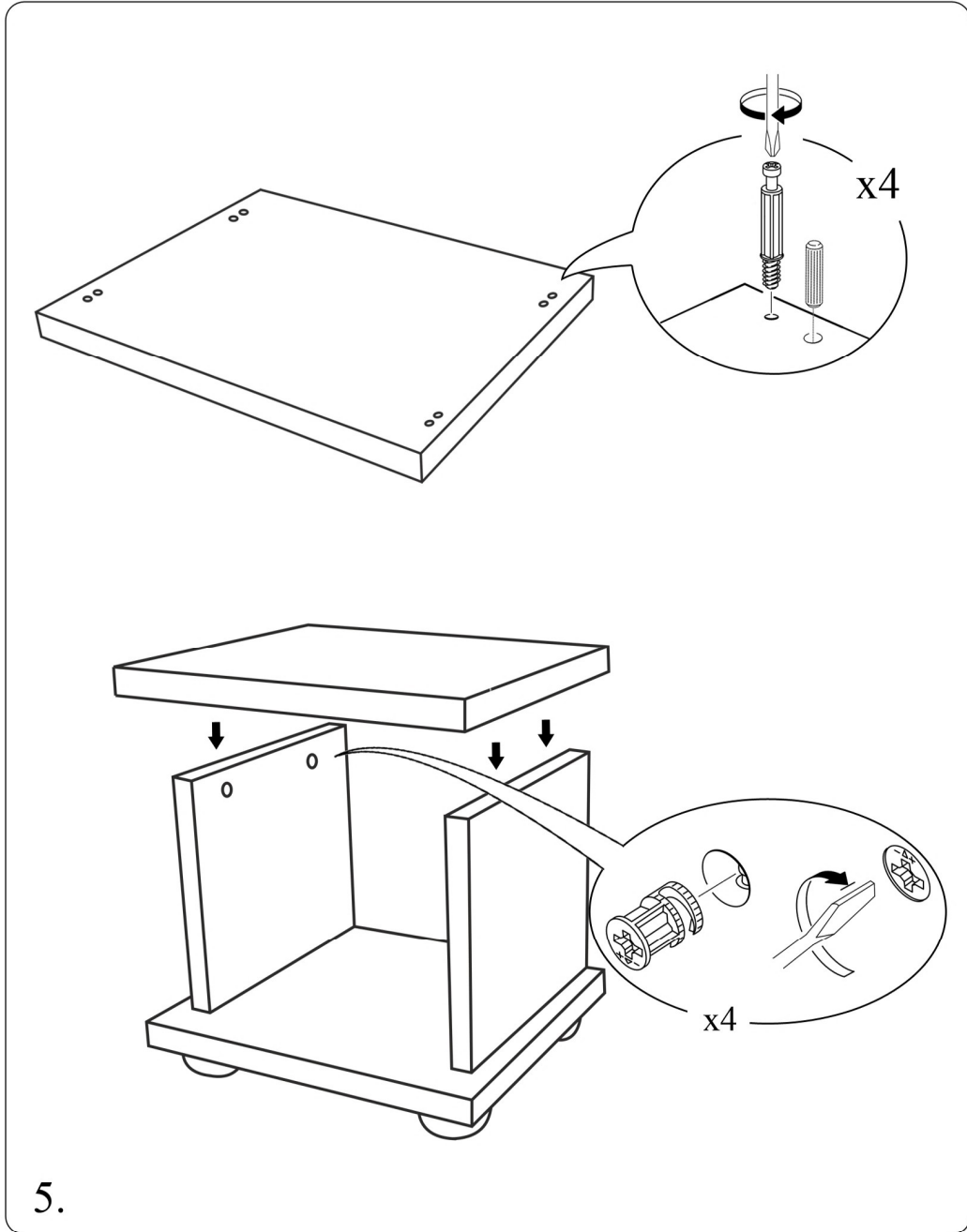

SN SZUFLADA

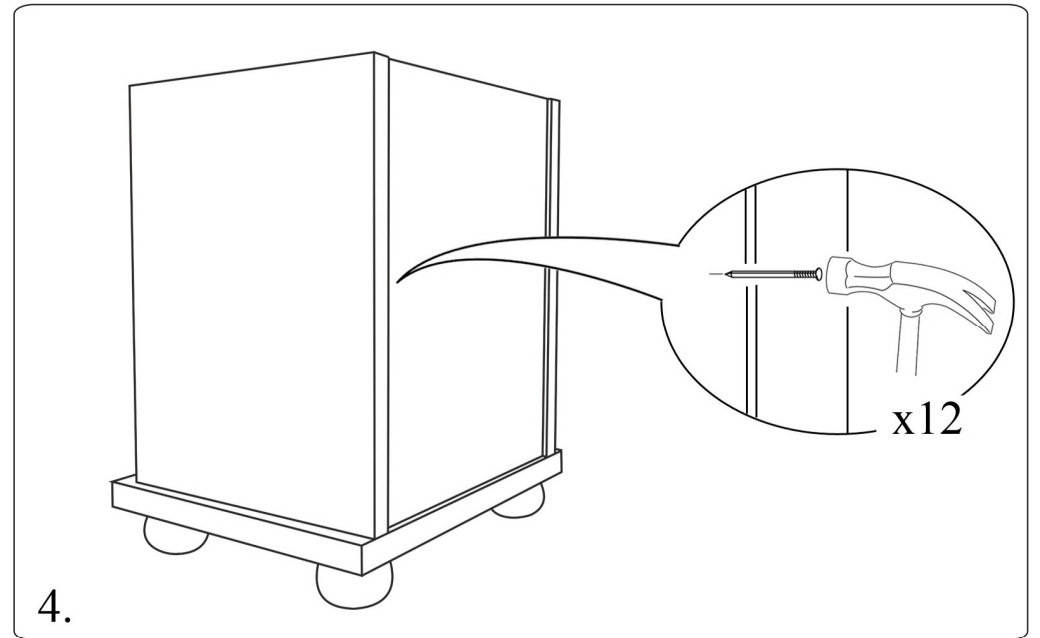
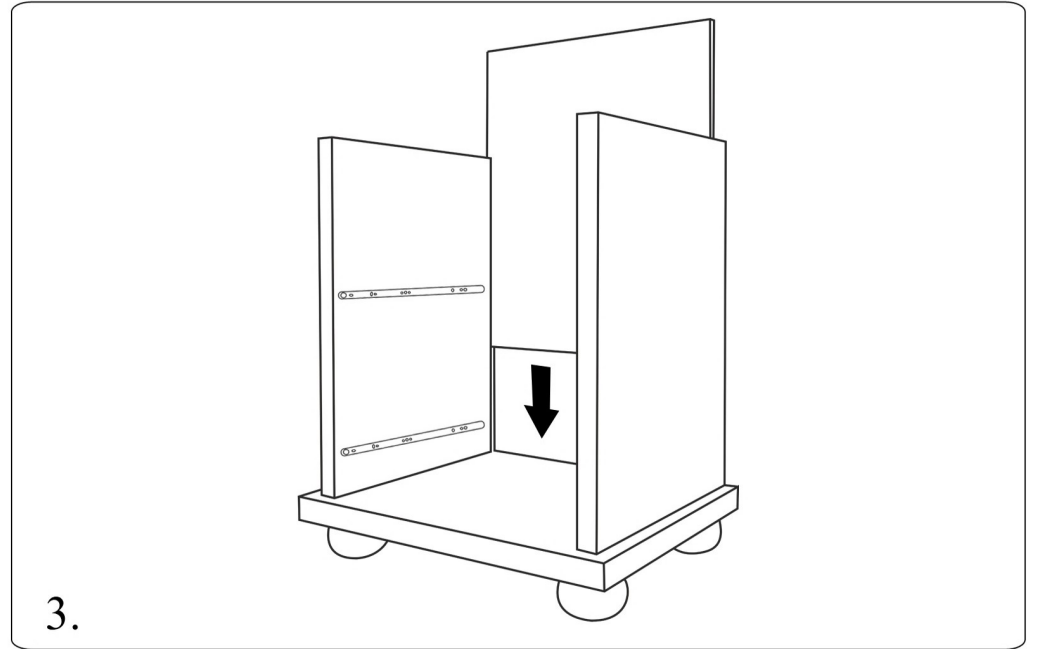
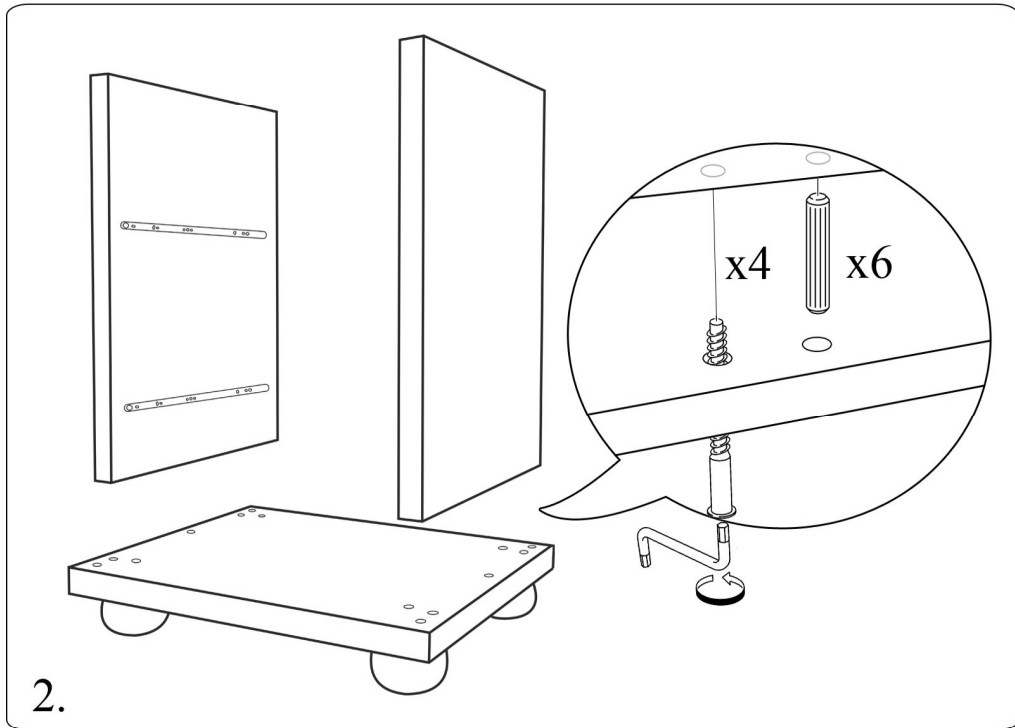
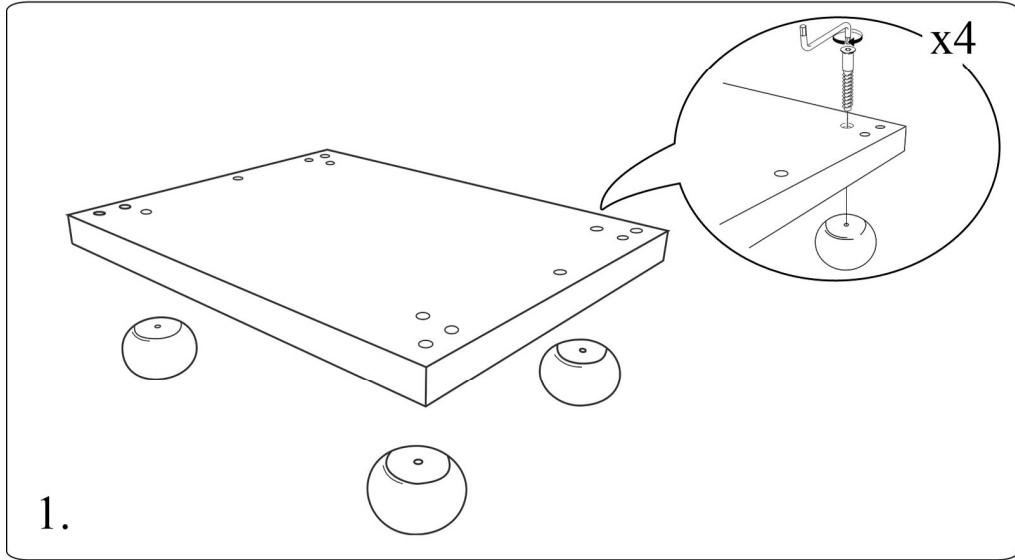