

SN 101 S42 W55 G35

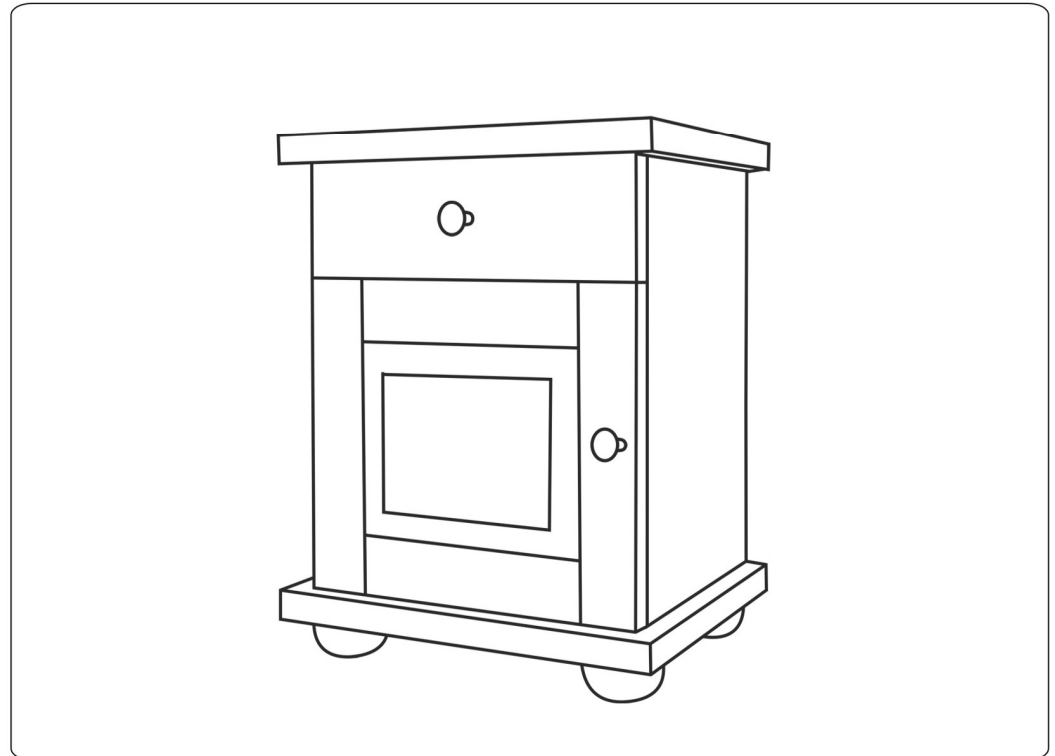

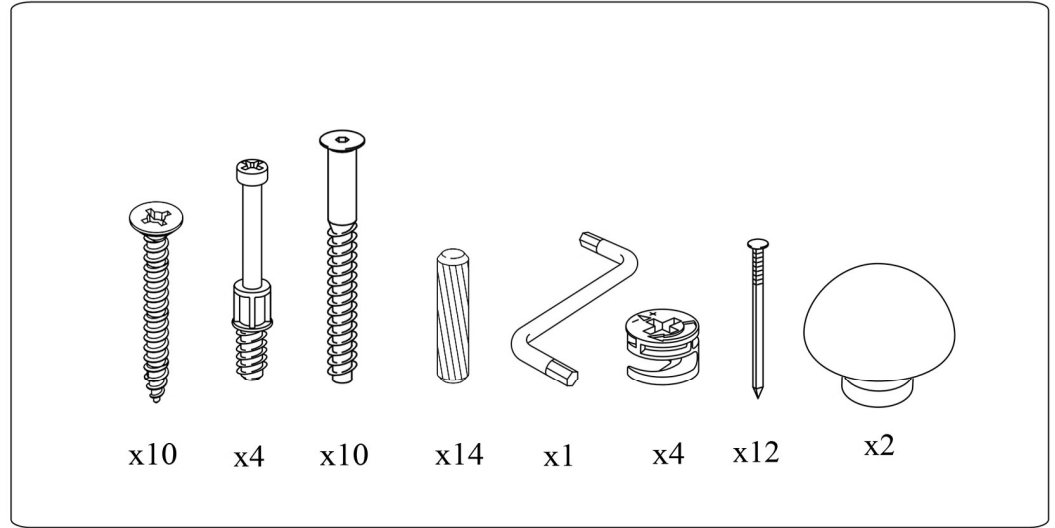

SN SZUFLADA

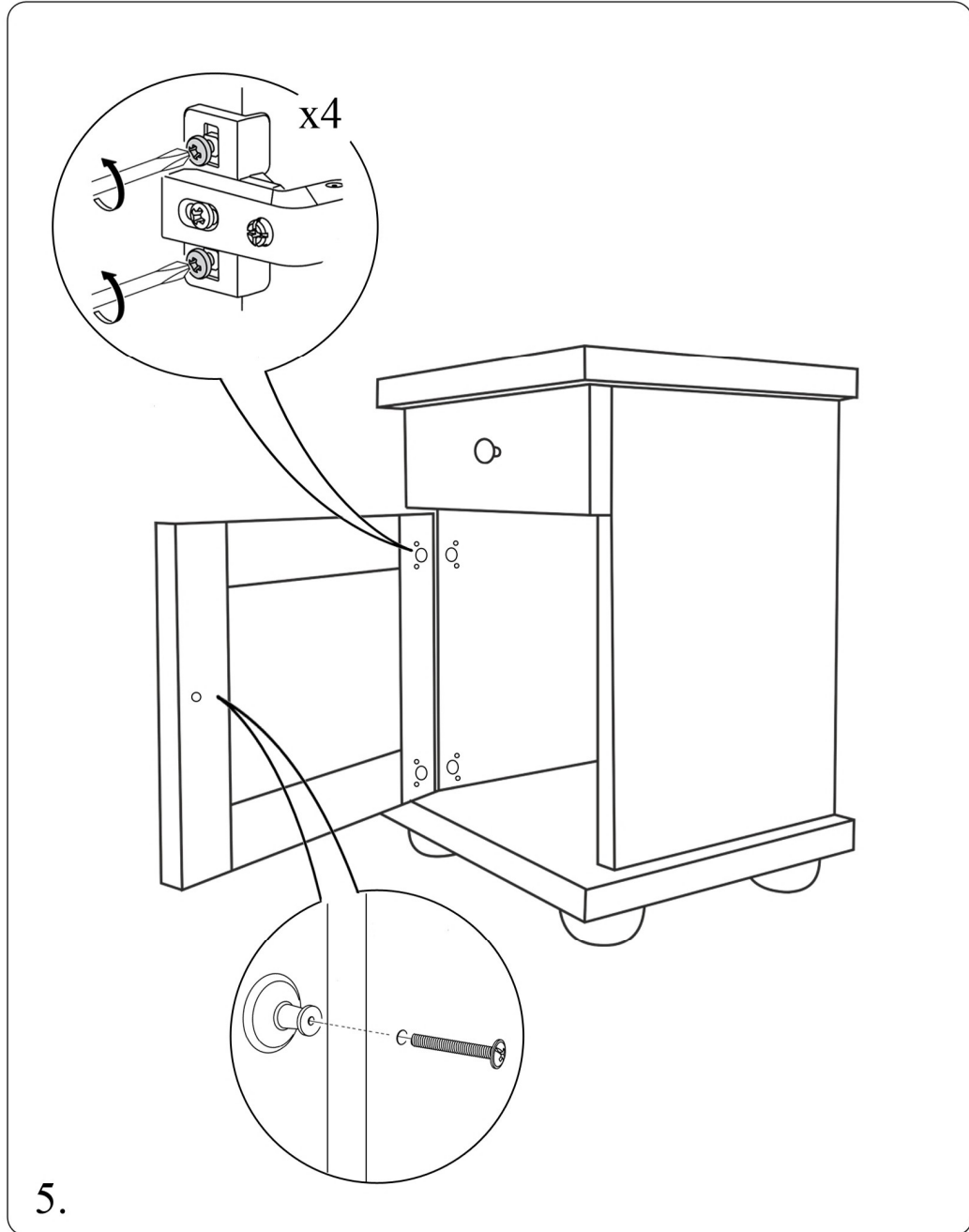
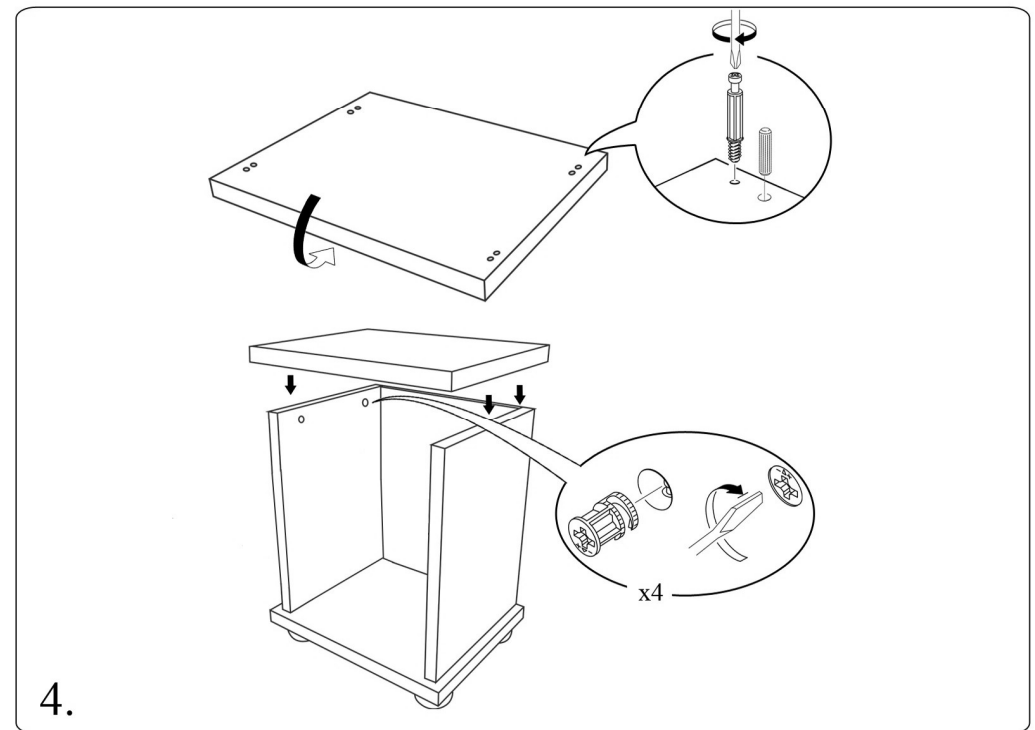
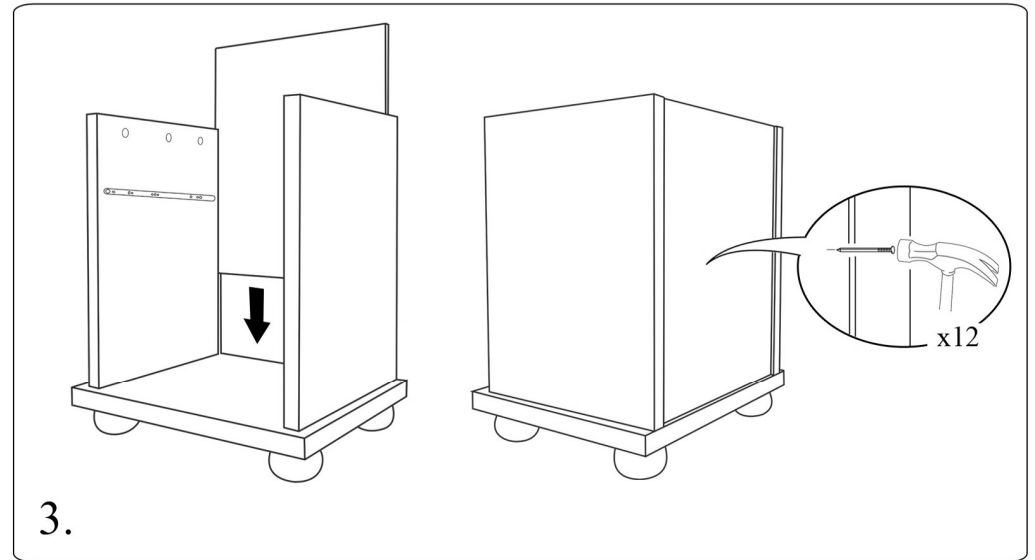
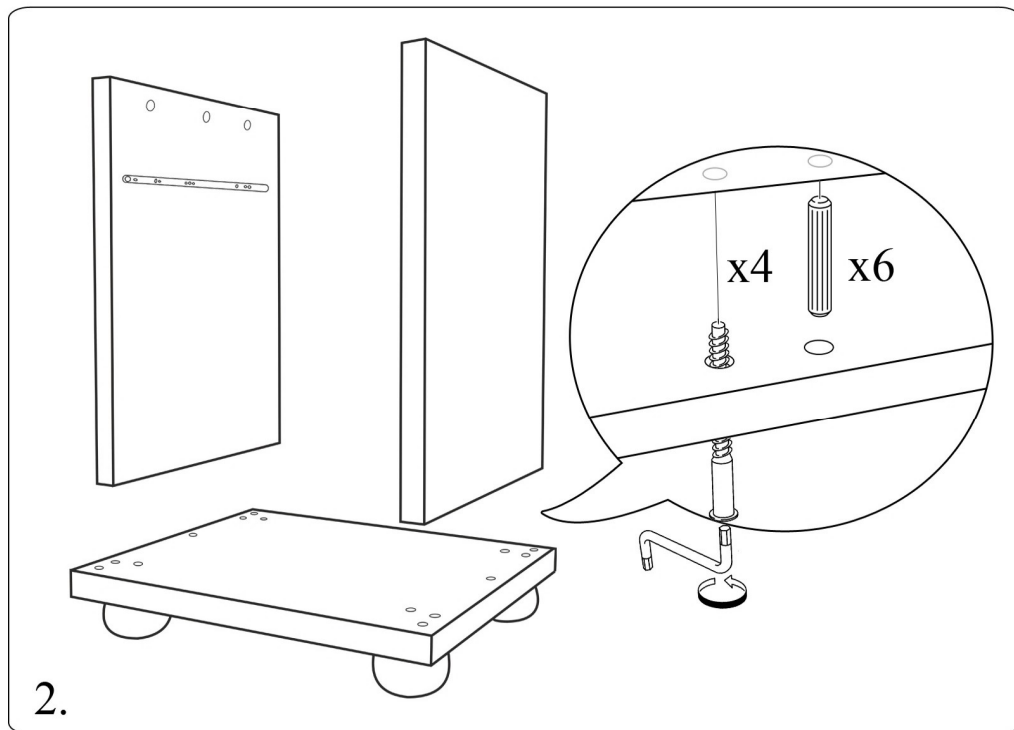
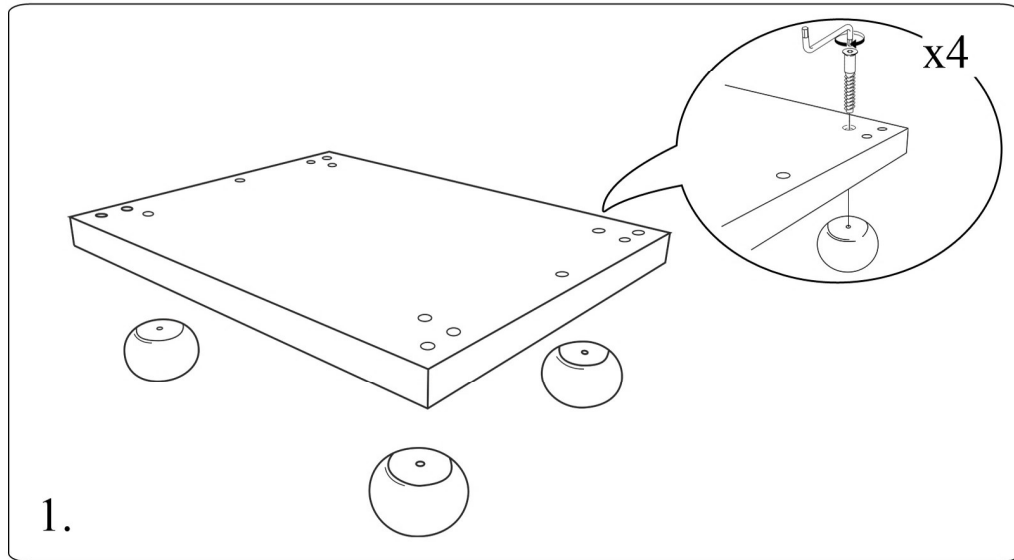