

BR 108 S130 W75 G90

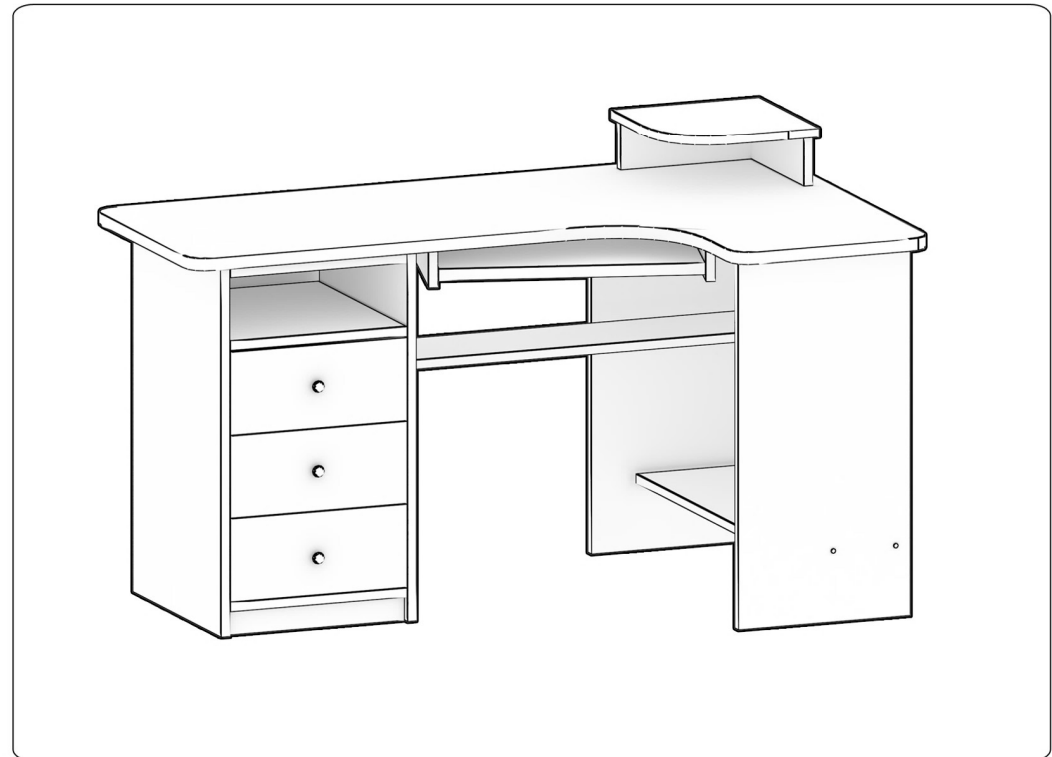

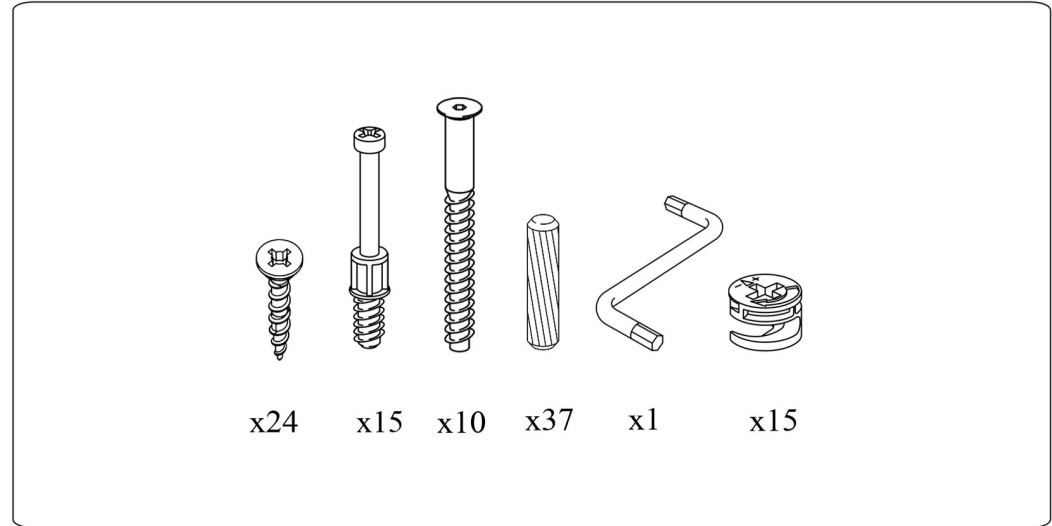

SZUFLADA

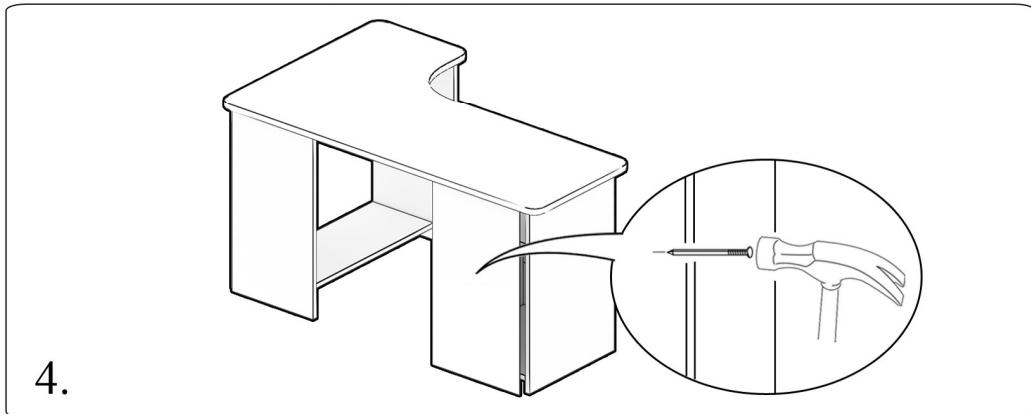
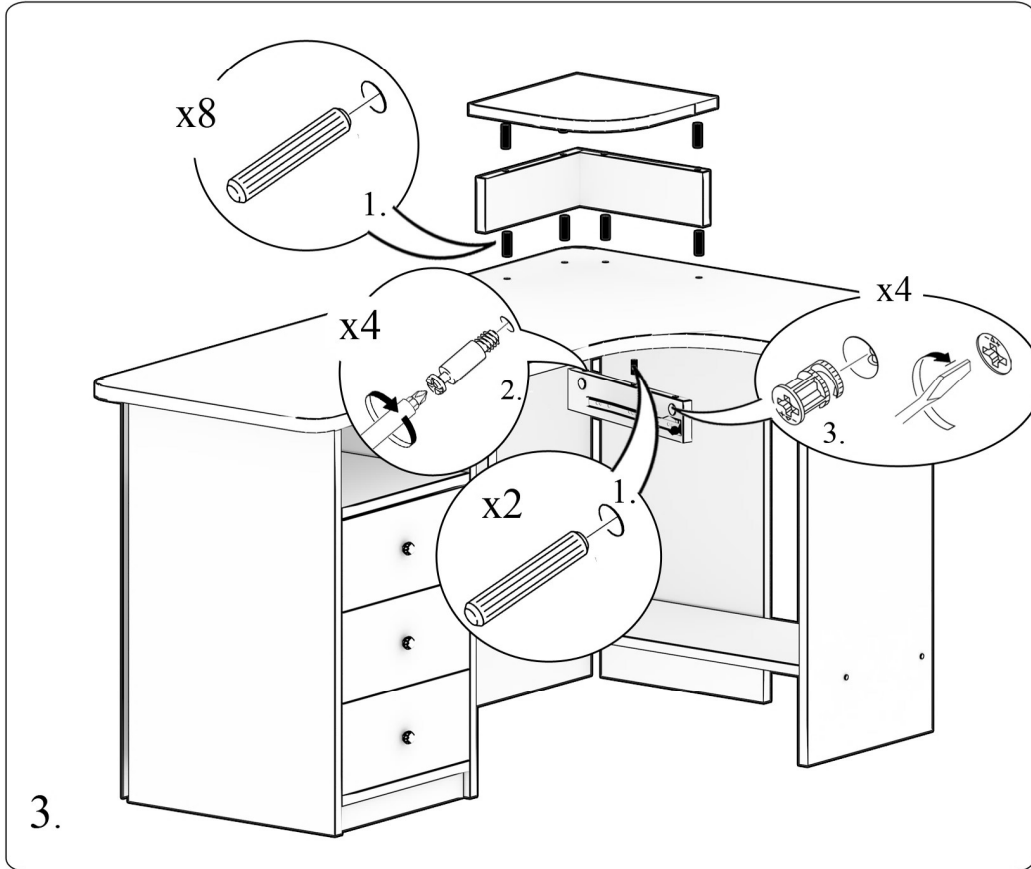
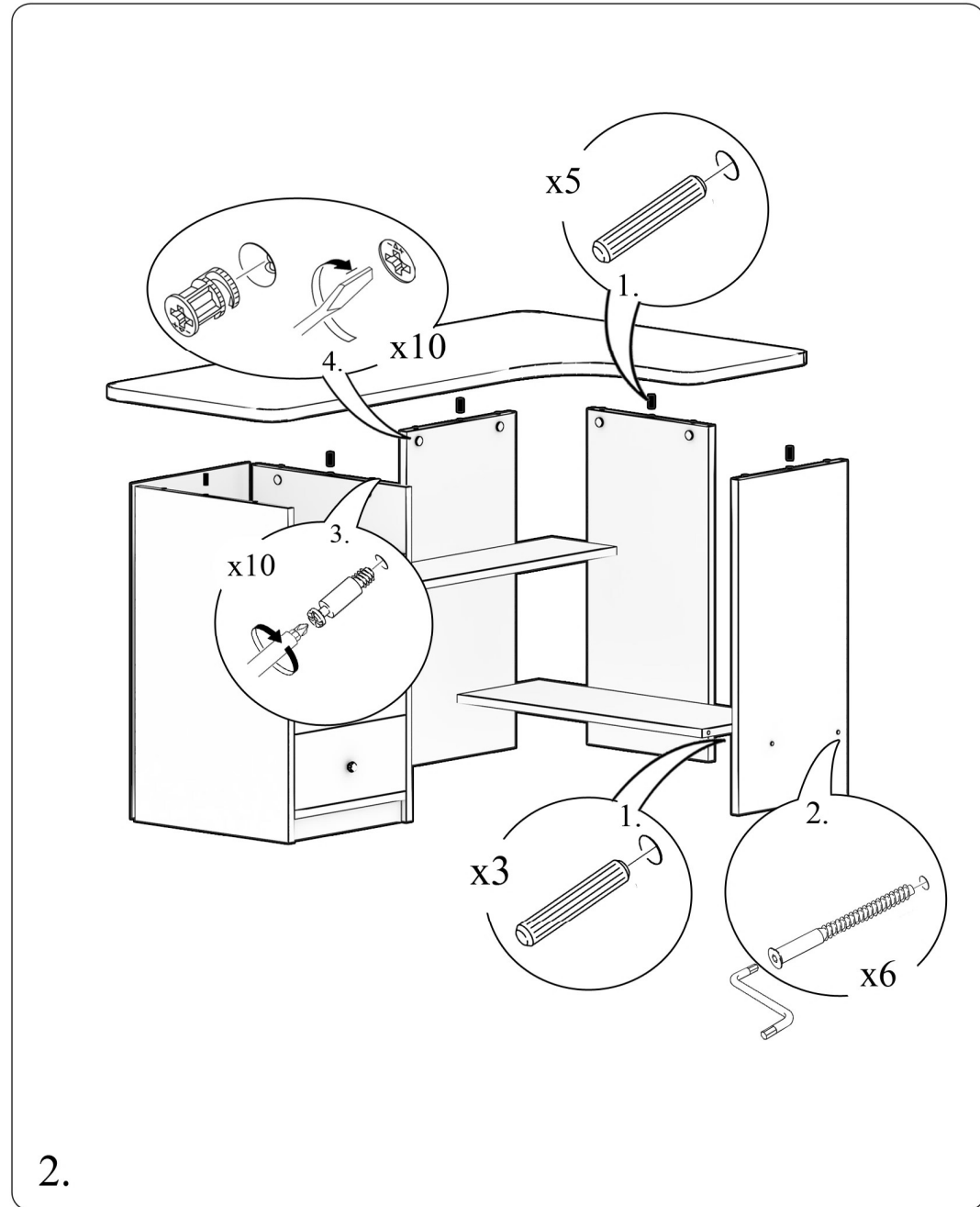
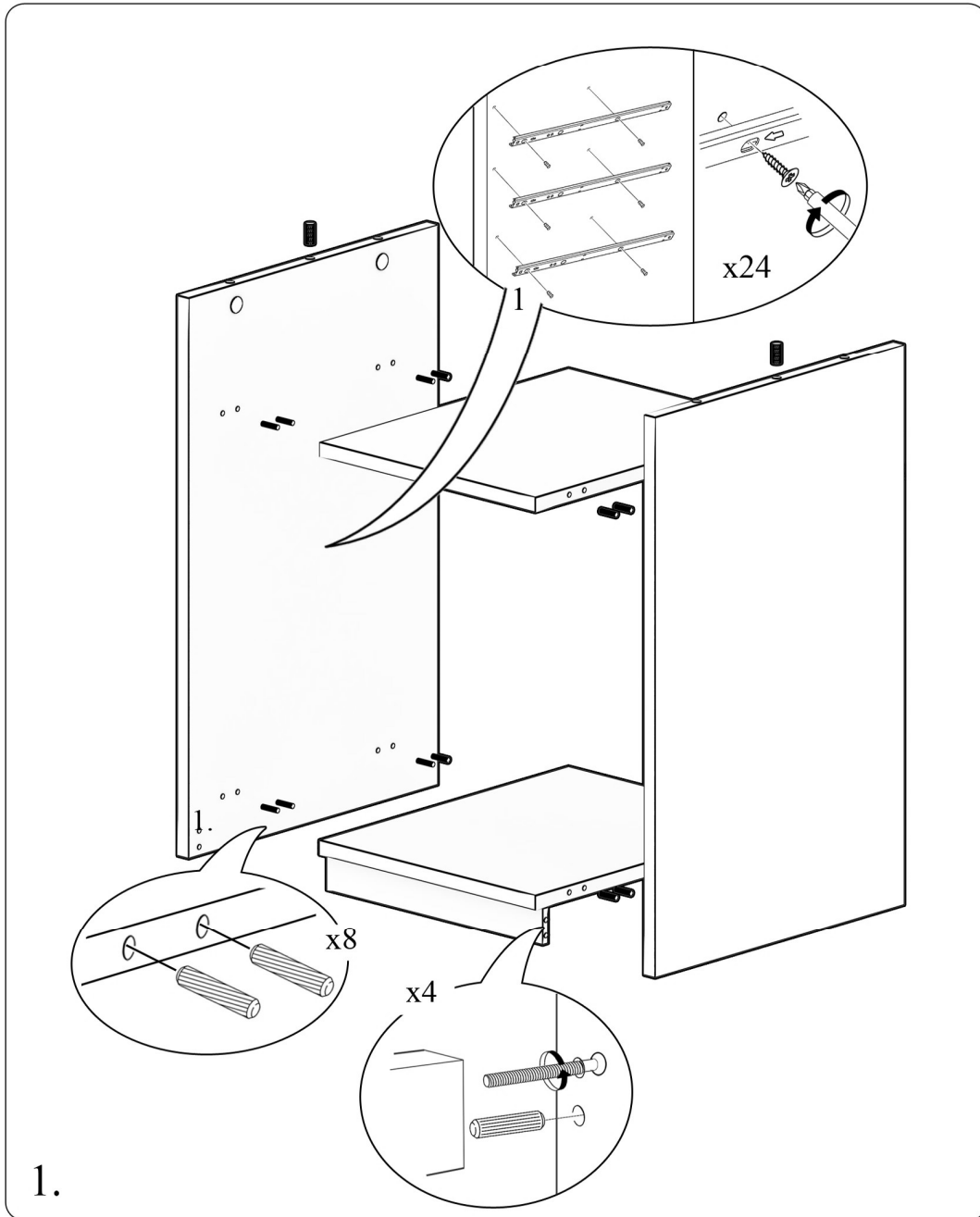