

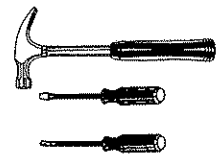









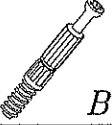

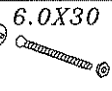
# PIK-POK PP-10

**DIG-NET**®  
Dan Lenart  
**meble**



						
30	30	30	1KPL	6	54	8
<p>Szanowny kliencie, gdyby brakowało jakiegś części, lub byłaby uszkodzona proszę to oznaczyć na instrukcji montażowej i przesać razem z reklamacją.                  UWAGA! Jeżeli uszkodzony element będzie zamontowany na stałe reklamacja nie będzie uznana.                  Proszę czyścić tylko suchą lub lekko wilgotną szmatką do kurzu.                  Nie używać żadnych środków szorstkich!</p>						
				1 KPL	2	1
				<b>KLEJ</b>	3.5X16	3.5X45
						
2	8	4				

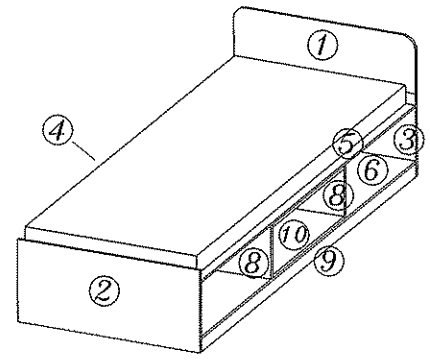

1

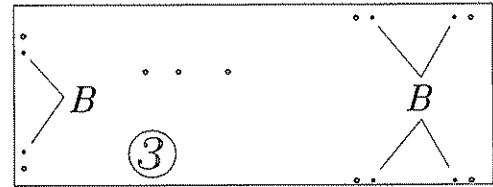
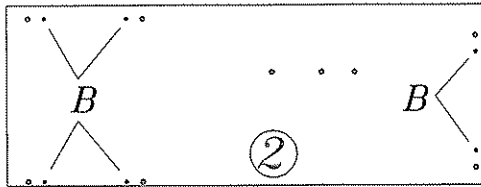

2

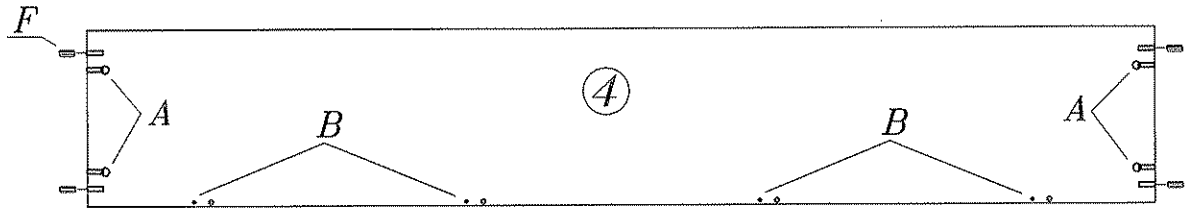

3

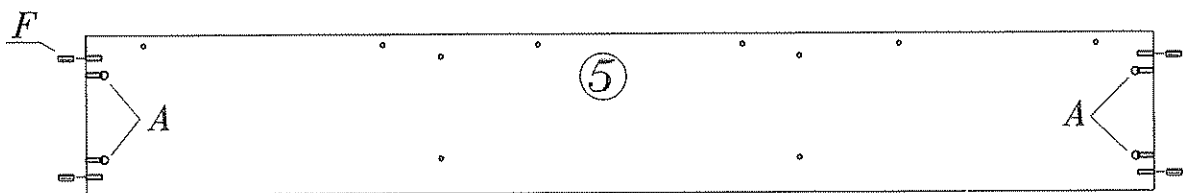

4

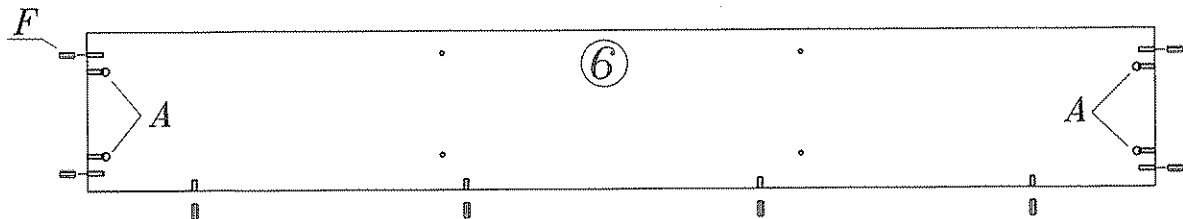

5

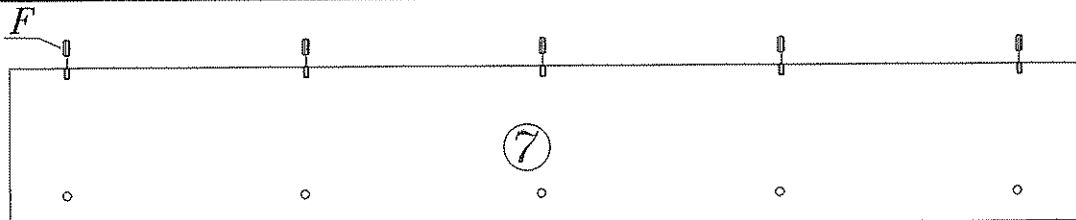

6

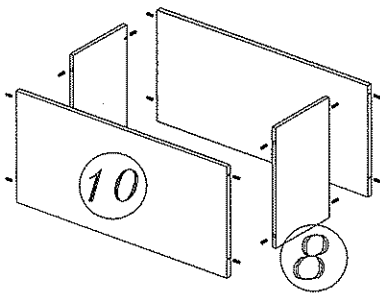

6

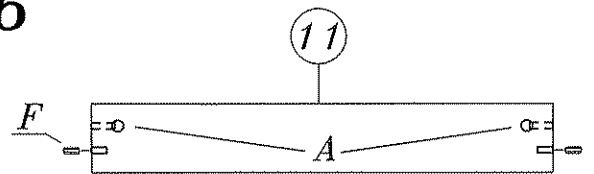

7

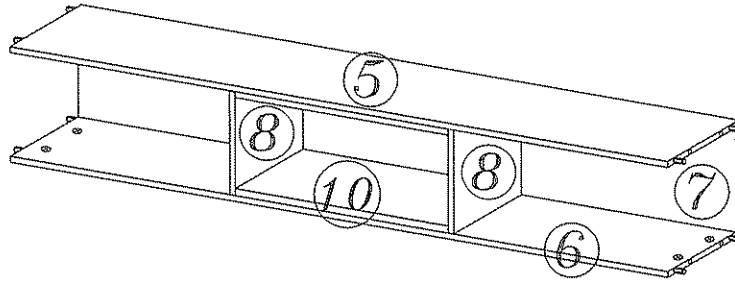
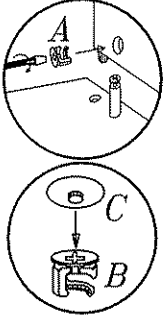

8

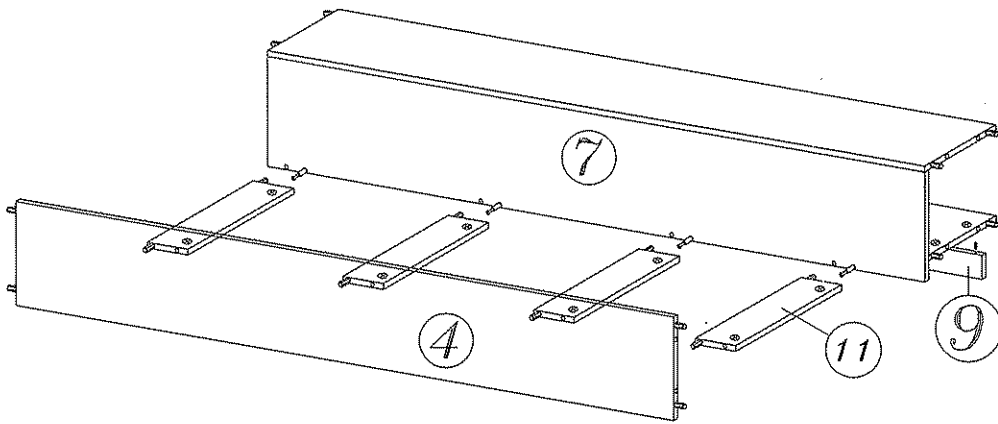
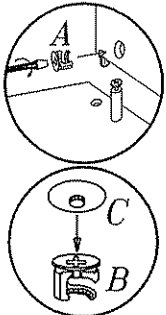

9

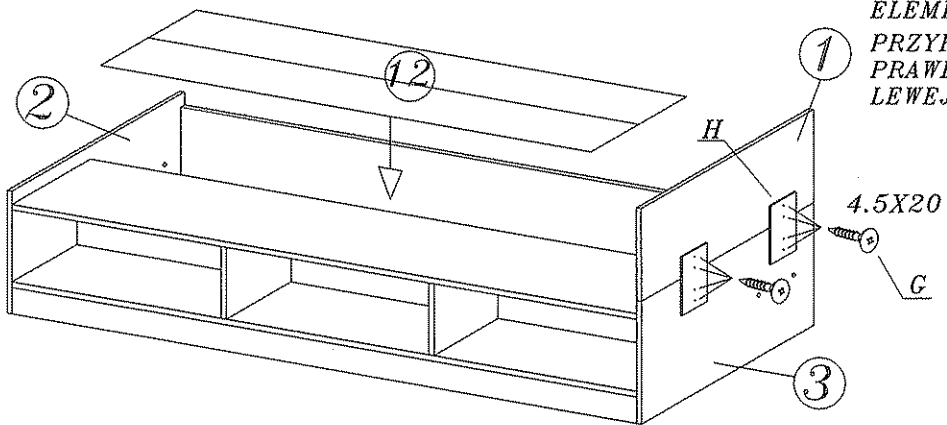
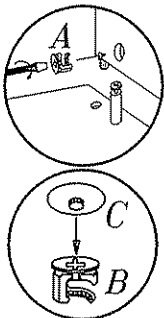

ELEMENT ① MOŻNA  
PRZYKRĘCIĆ Z  
PRAWYJ, LUB Z  
LEWEJ STRONY

10

