

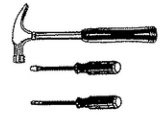











# MARIO M-7

**DIG-NET**®  
Dan Lenart  
**meble**



 A	3.5X16  B	4.0X30  C	 H	 I	
56	20	8	2	4	
 D	450  E	 F	 G	4.0X16  J	5.0x13  K
40	4kpl	4	2	8	16

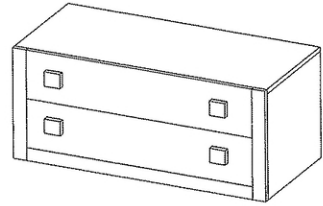

1

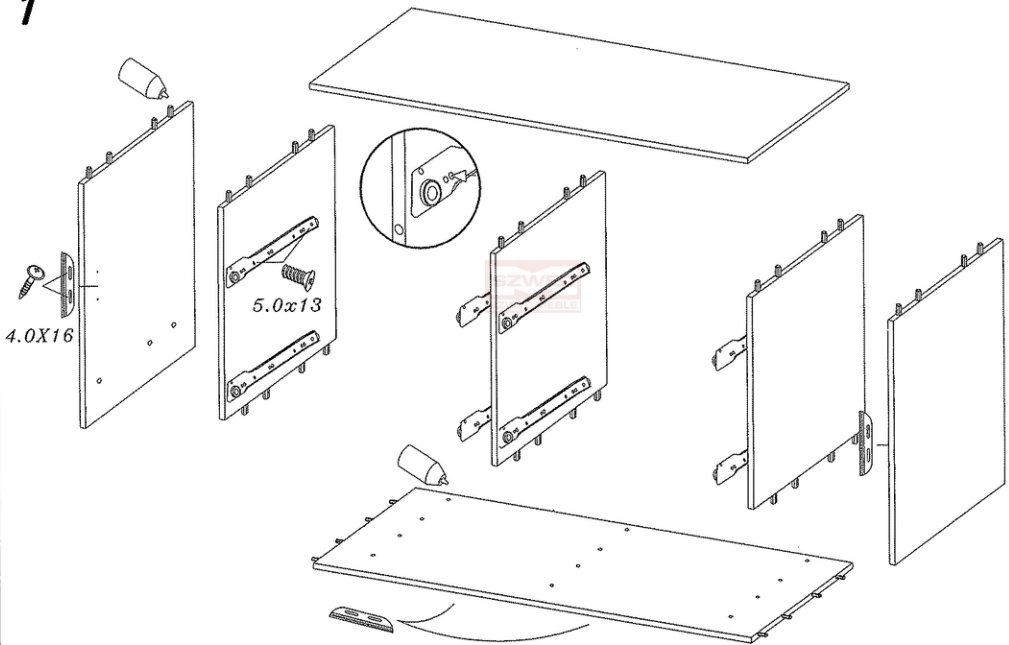

2 3

