

A**ZELE****S383-POL/135**

| A | B | C | D |
|---|-----------|------|-----|
| 1 | S383-3014 | 1348 | 170 |
| 2 | S383-4003 | 1350 | 200 |

1 §2

2

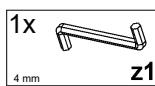
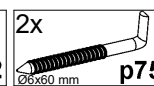
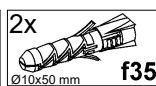
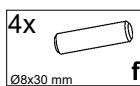
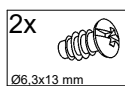
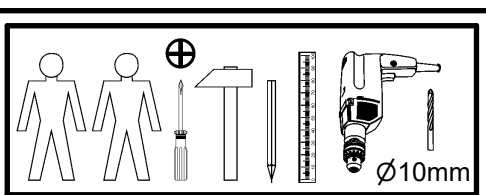
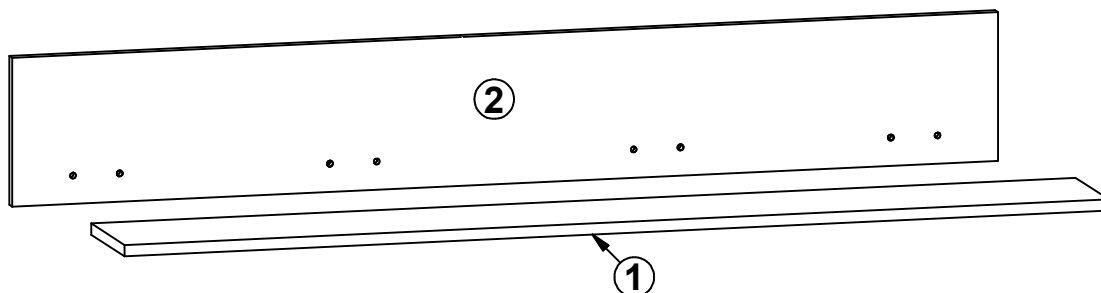
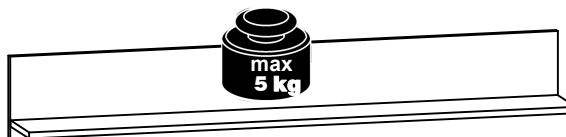
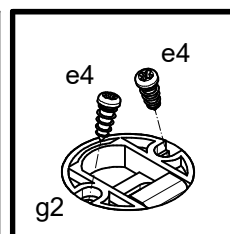
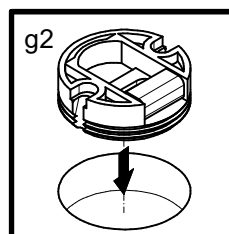
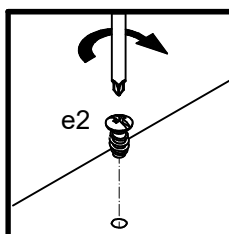
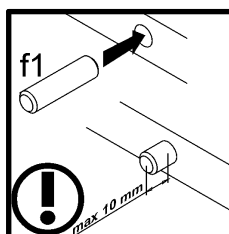
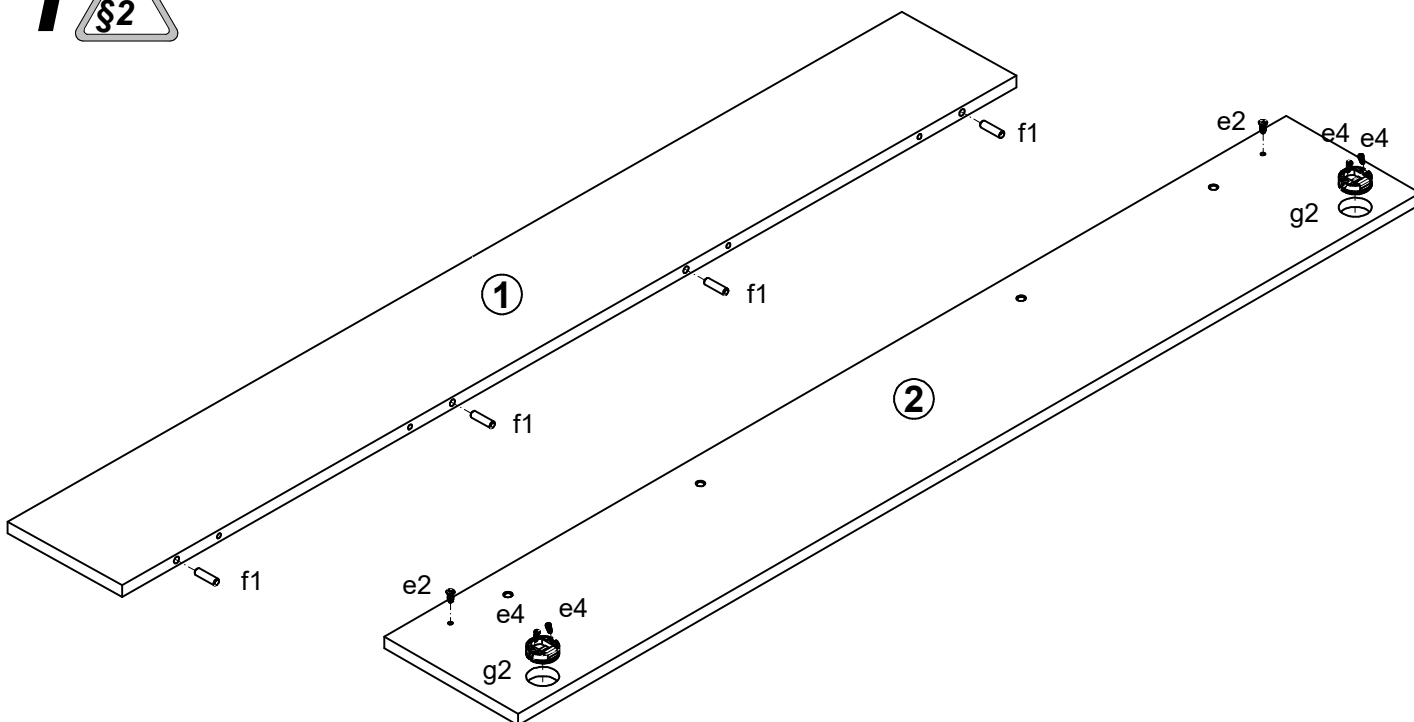
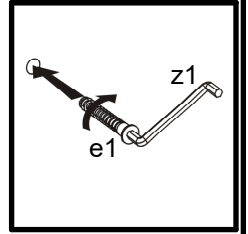
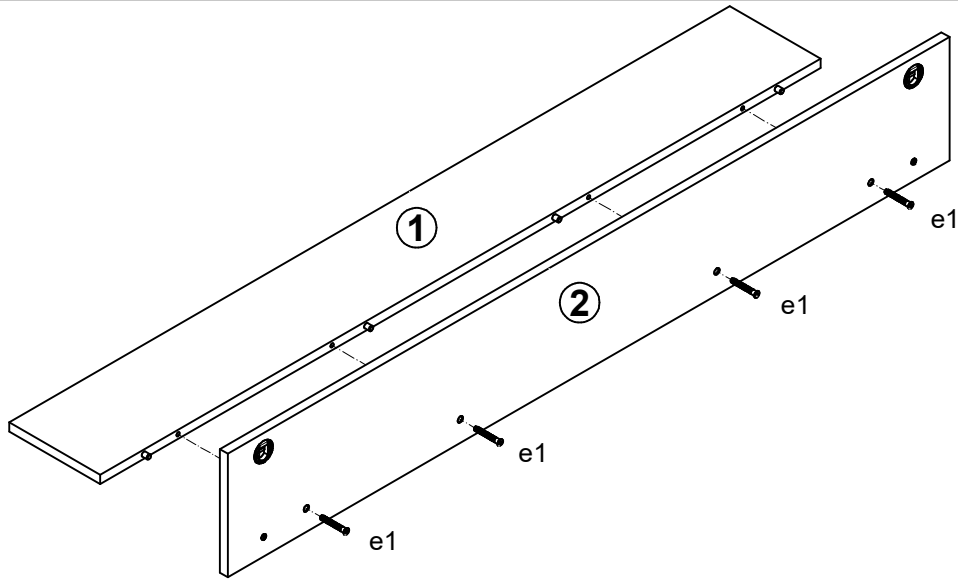

3



φ10 mm

