

**A**

# HAREN

**S400-SZF4D**

A	B	C	D	
1	S400-0005	602	446	3/3
2	S400-0006	602	446	3/3
3	S400-0007	1296	446	3/3
4	S400-1005	1908	560	1/3
5	S400-1006	1908	560	1/3
6	S400-2002	933	561	2/3
7	S400-3005	900	542	2/3
8	S400-3006	900	526	2/3
9	S400-3007	899	514	2/3
10	S400-4001	900	65	2/3
11	S400-9302	1902	909	1/3
12	S332-5001	120	50	2/3
13	S332-5002	120	50	2/3
14	S332-5003	120	50	2/3
15	dr-897x30	897,	30	2/3

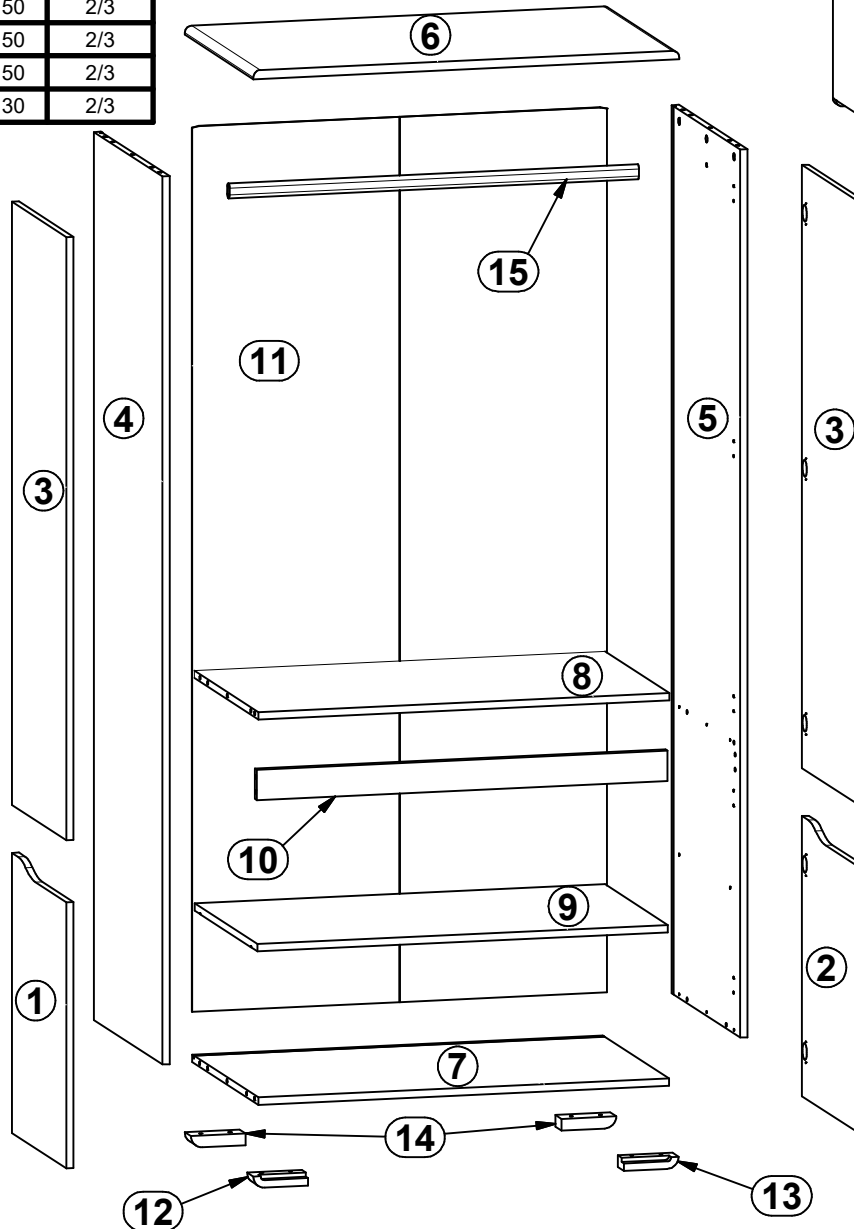
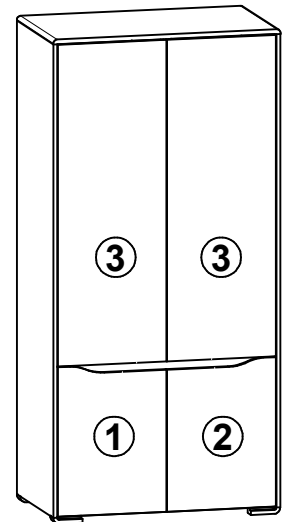
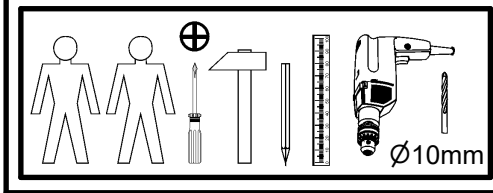

10x K 16 90°, Ø35 <b>a160</b>	10x <b>b43</b>	4x Ø5x17 mm <b>d1</b>	2x Ø6.3x15 mm <b>d5</b>	20x Ø6.3x13 mm <b>e2</b>	8x Ø6x22 mm <b>e31</b>	16x Ø8x30 mm <b>f1</b>	10x 1.4x20 mm <b>l1</b>	18x <b>l2</b>
2x <b>n158</b>	4x silikon <b>o21</b>	2x Ø3.5x13 mm <b>p1</b>	20x Ø3.5x15 mm <b>p51</b>	18x Ø15x12 mm #16 <b>r1</b>	18x 20/11 <b>r42</b>	6x Ø16 <b>s2</b>		
							1x <b>n2611</b>	1x Ø3.5x16 mm <b>p38</b>

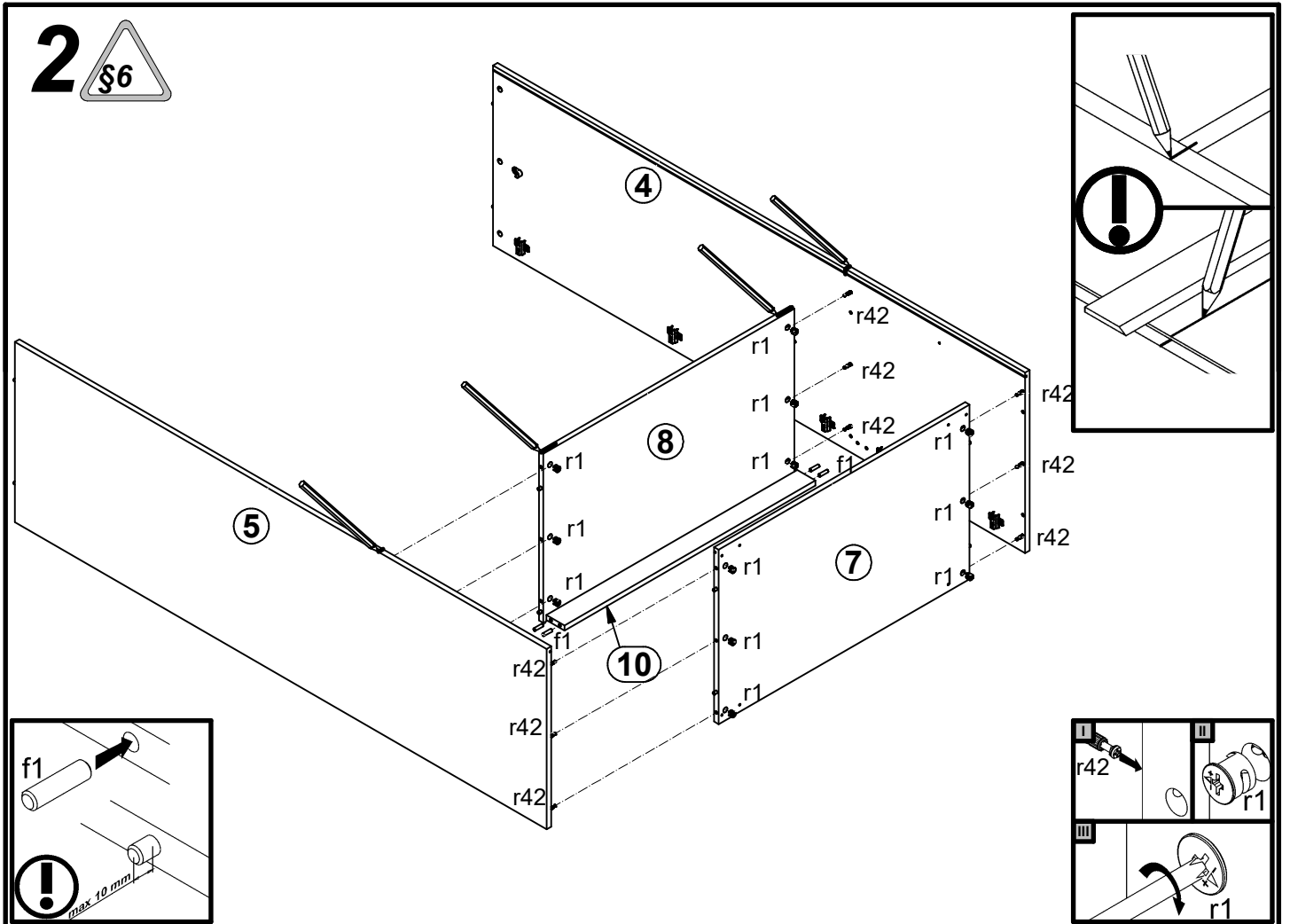
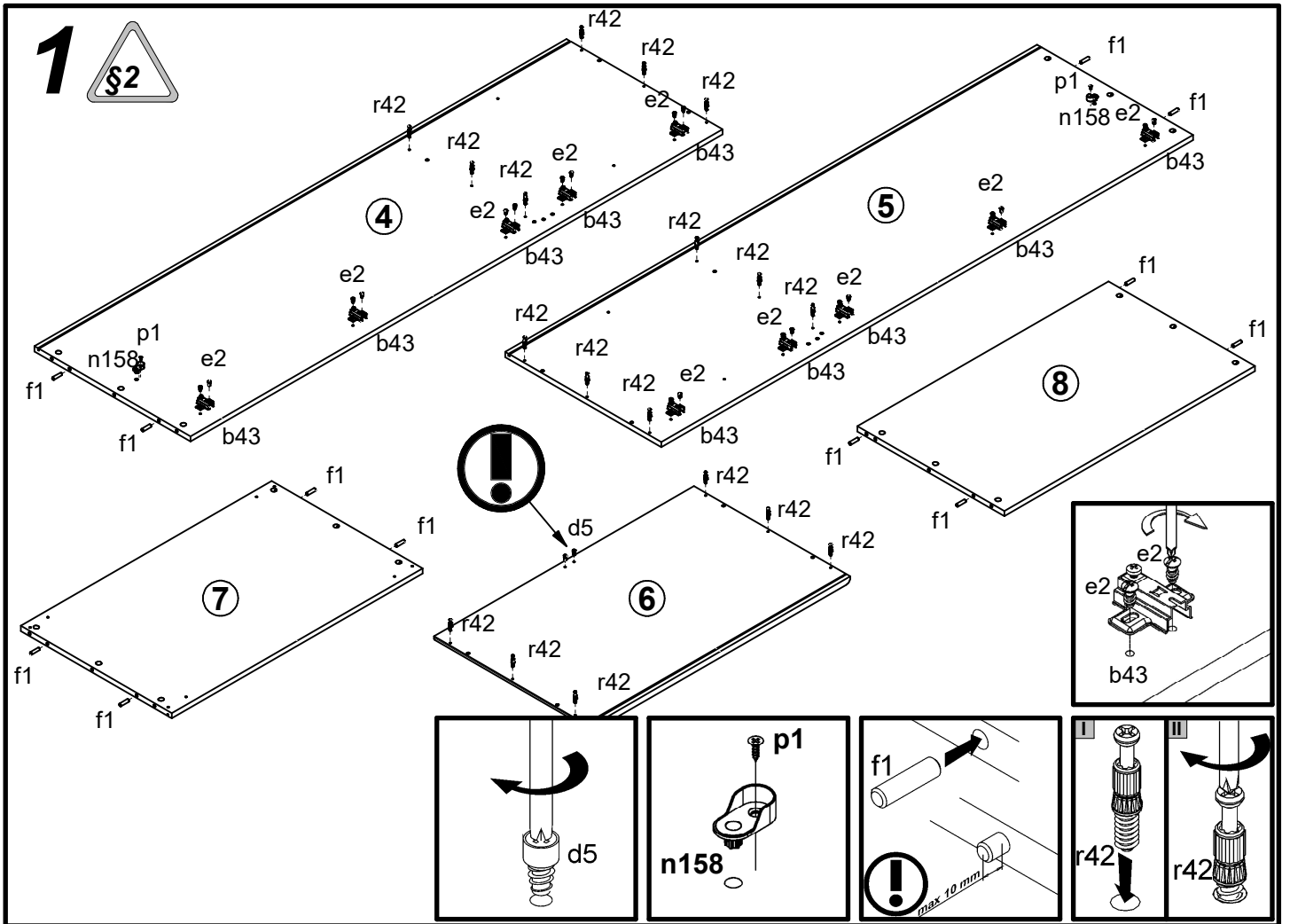

# 3

## I

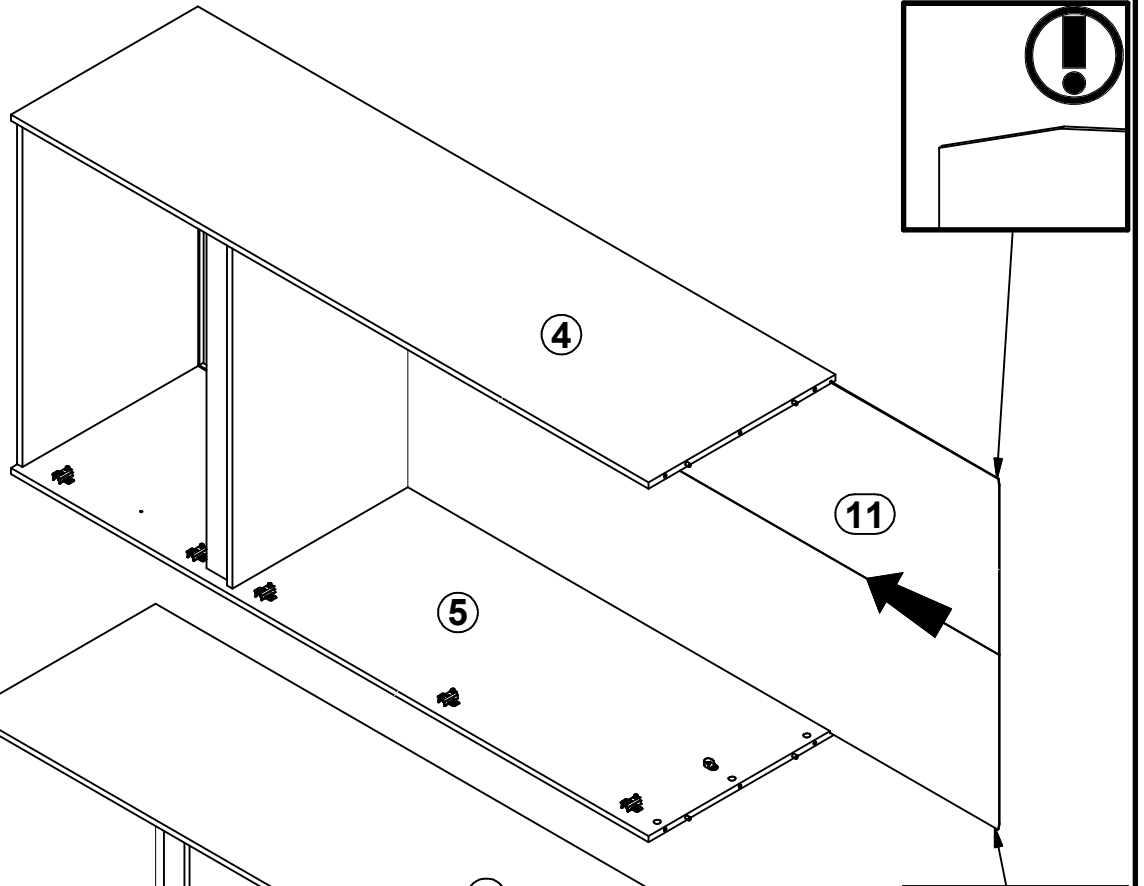

## II

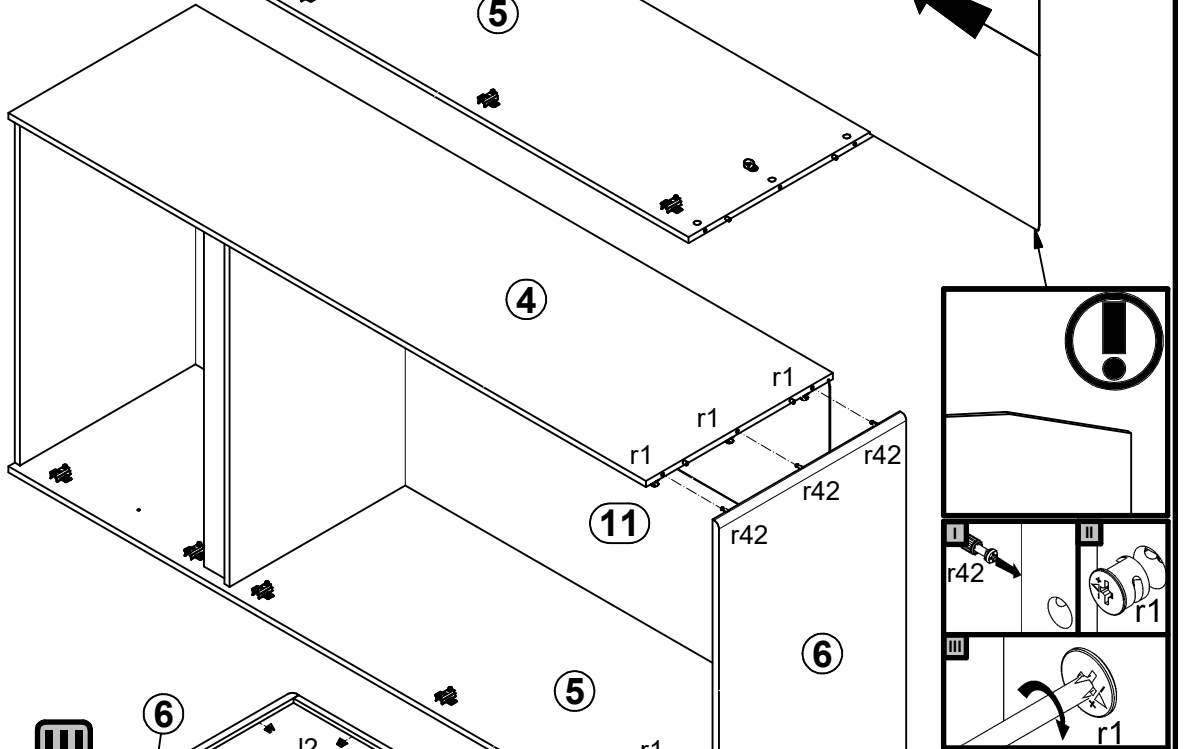

## III

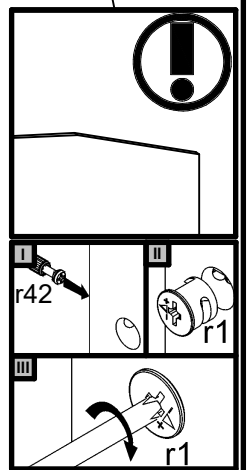
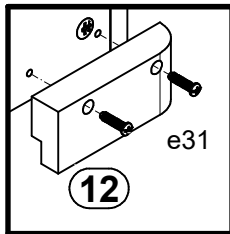
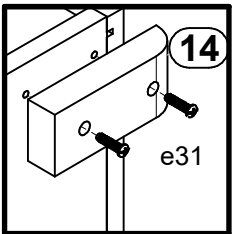
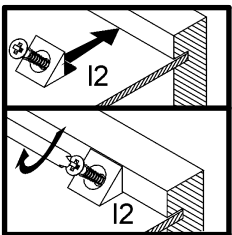
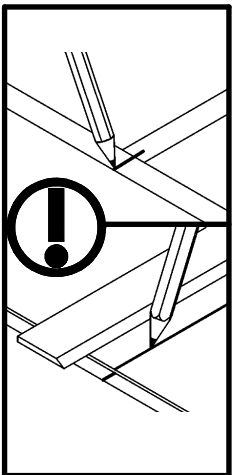
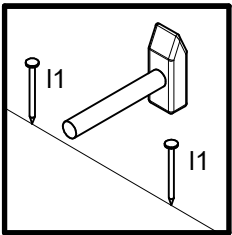
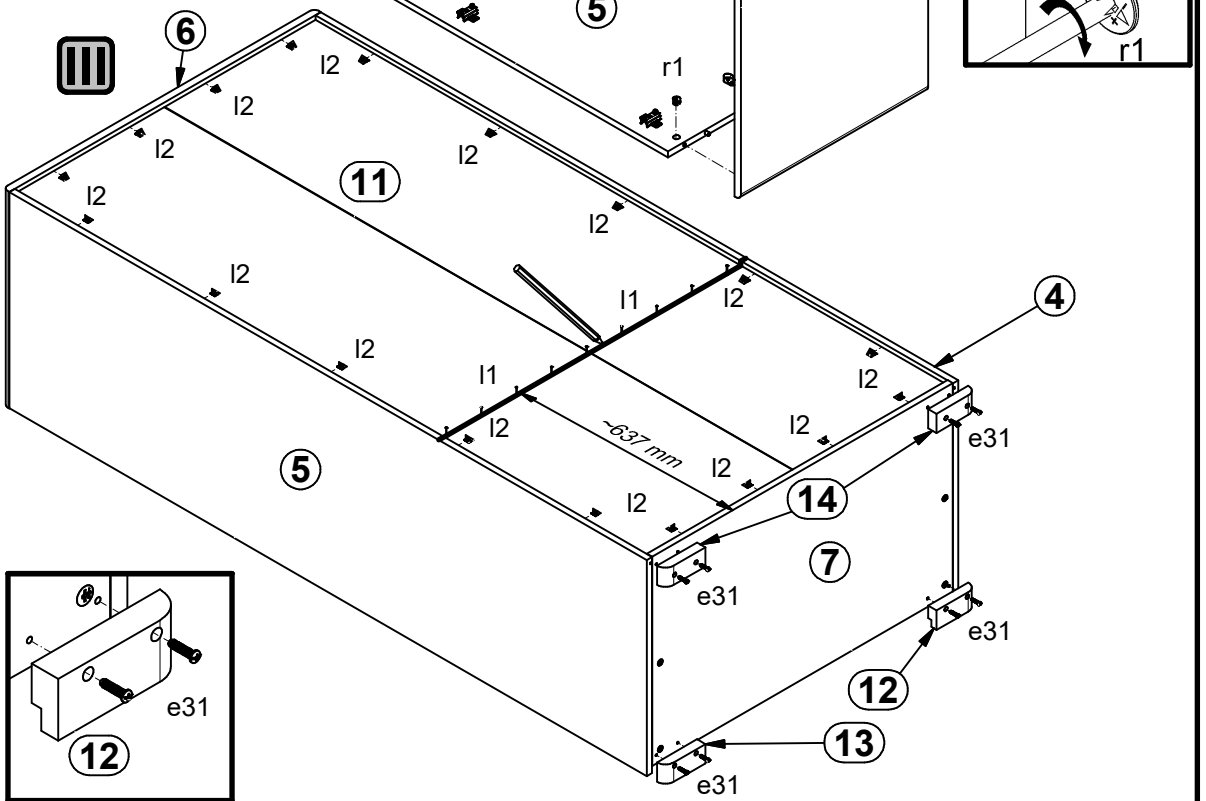

# 4

