

A

HAREN

S400-REG1W3D

A	B	C	D	A	B	C	D		
1	S400-0001	546	602	3/3	13	S400-3003	332	331	1/3
2	S400-0002	346	602	3/3	14	S400-3017	550	354	1/3
3	S400-0003	346	600	3/3	15	S400-3019	550	331	1/3
4	S400-0004	546	198	3/3	16	S400-3020	332	354	1/3
5	S400-0022	546	198	3/3	17	S400-4001	900	65	1/3
6	S400-1001	1212	400	1/3	18	S400-5002	545	284	3/3
7	S400-1002	1212	400	1/3	19	S400-9001	1206	346	1/3
8	S400-1003	601	335	1/3	20	S400-9301	1206	563	1/3
9	S400-1004	579	365	1/3	21	S332-5001	120	50	3/3
10	S400-2001	933	401	2/3	22	S332-5002	120	50	3/3
11	S400-3001	900	382	2/3	23	S332-5003	120	50	3/3
12	S400-3002	900	366	2/3					

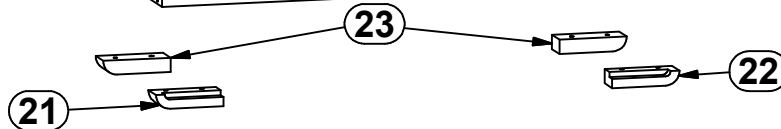
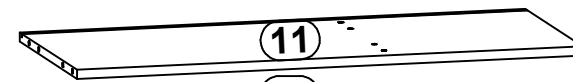
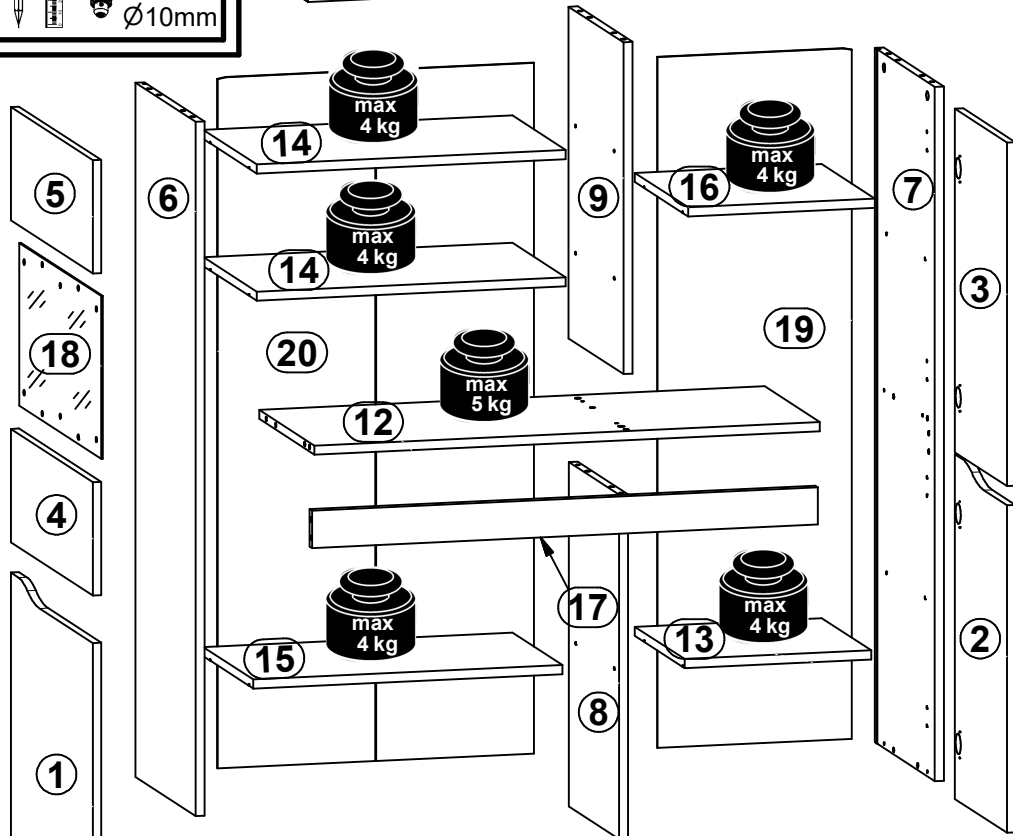
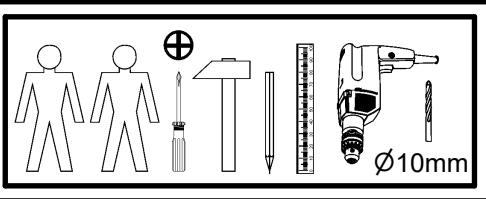
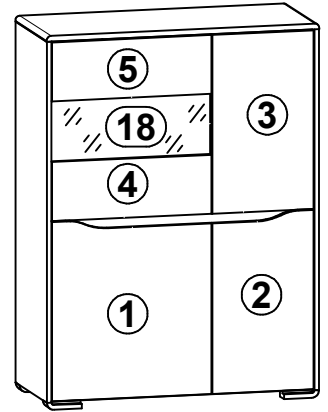

8x K 16 90°, Ø35 a160	8x b43	20x Ø5x17 mm d1	4x Ø7x50 mm e1	16x Ø6,3x13 mm e2	8x Ø6x22 mm e31	10x Ø5x12 mm e41	24x Ø8x30 mm f1	1x 84x40/25 mm k77
10x 1,4x20 mm l1	16x l2	5x 22x9,5x20,7 mm n108	5x silikon o21	10x Ø5,3/Ø8,3x4,8 mm o54	2x Ø4x25 mm p36	16x Ø3,5x15 mm p51	5x Ø2,9x16 mm p55	16x Ø15x12 mm #16 r1
16x 20/11 r42	8x Ø16 s2	1x 4 mm z1						
							1x n26/1	1x Ø3,5x16 mm p38

1 

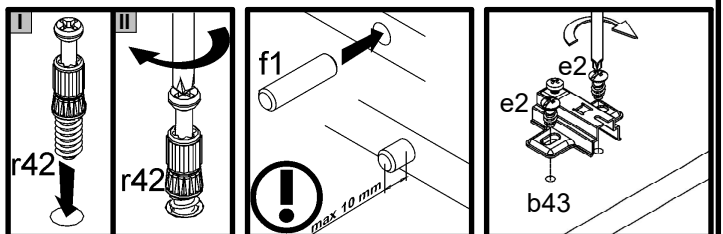
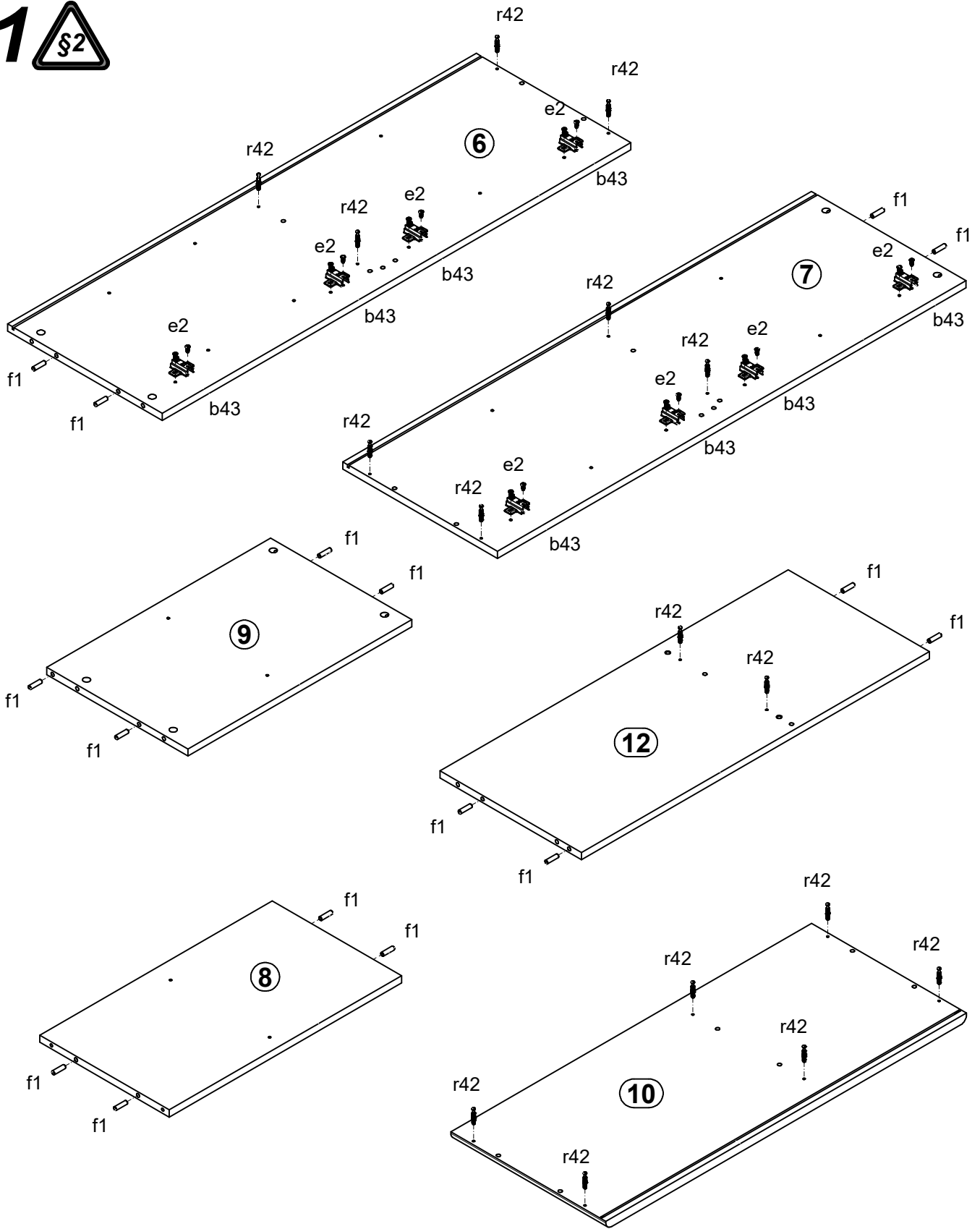

2

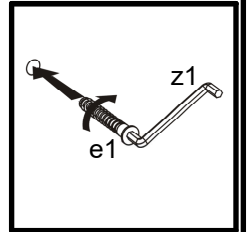
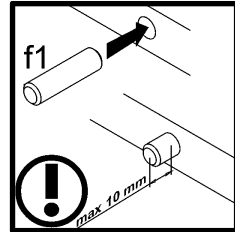
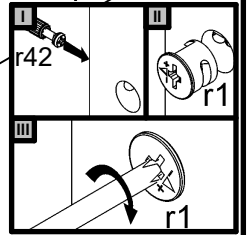
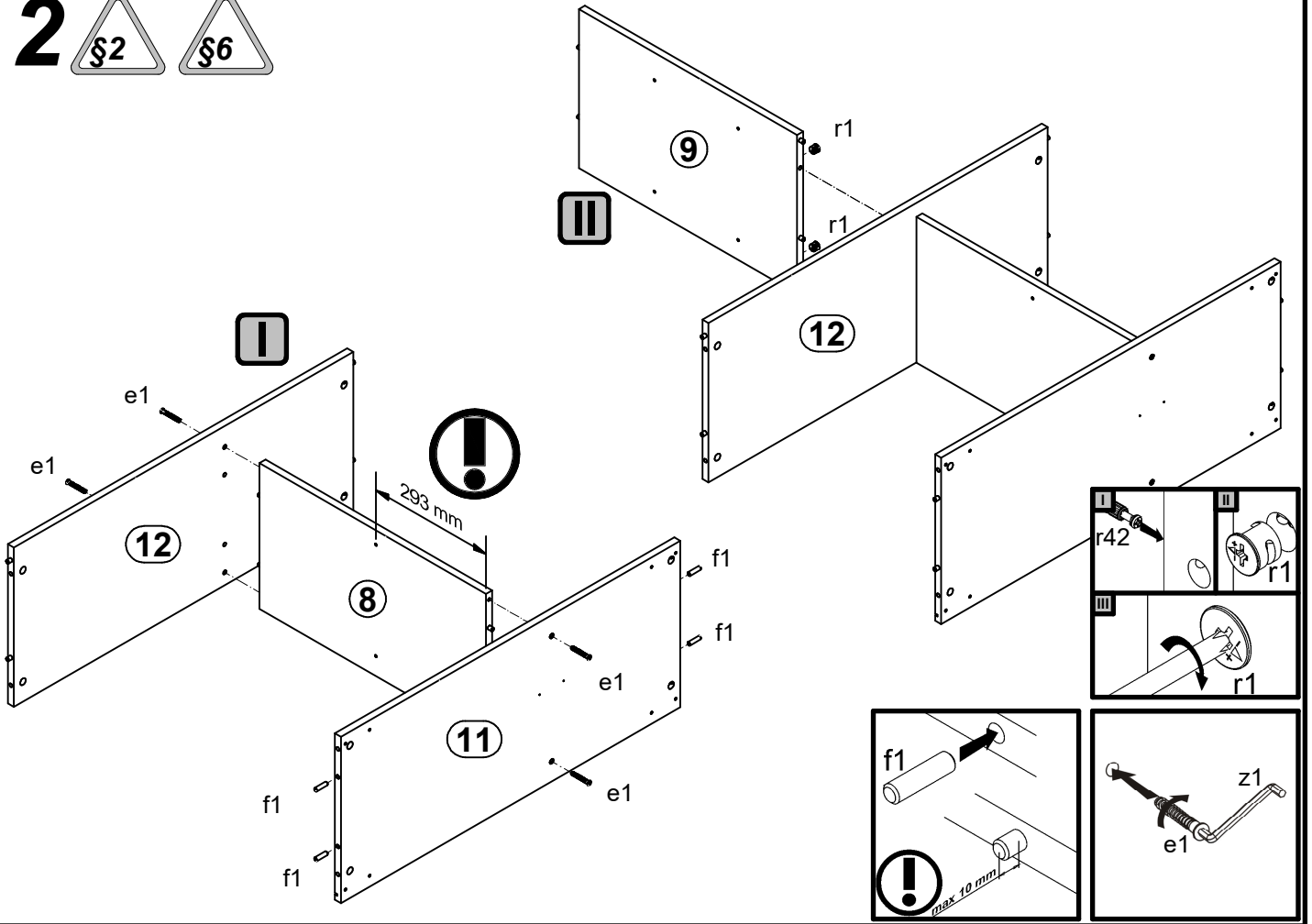

3

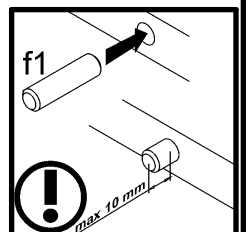
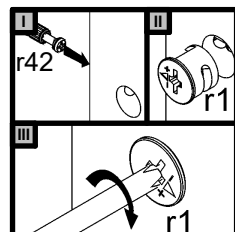
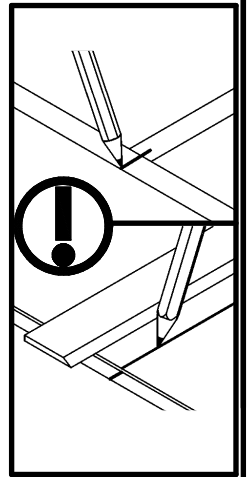
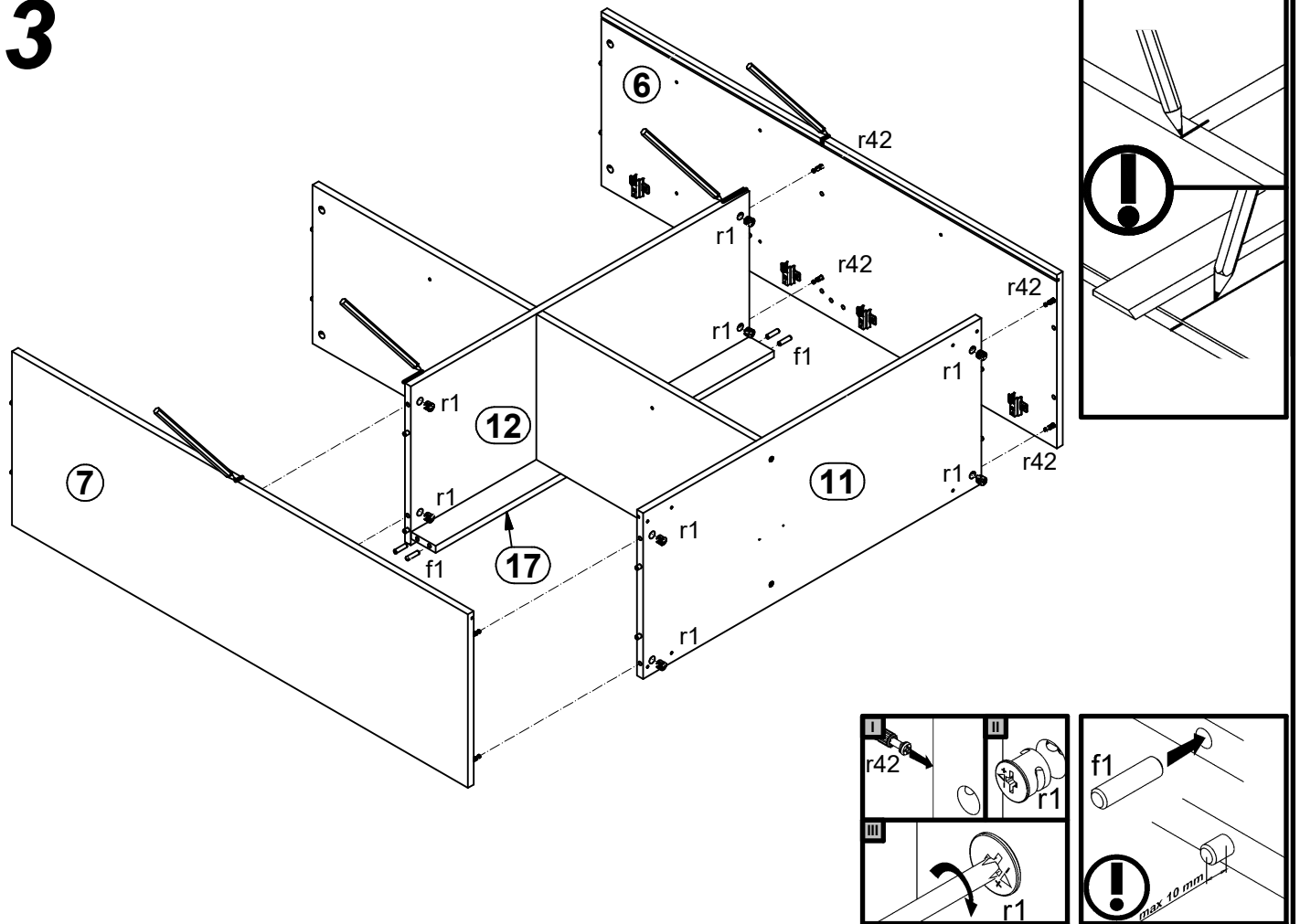

4

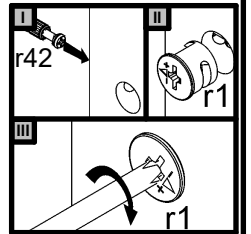
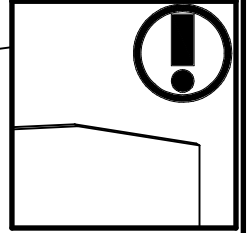
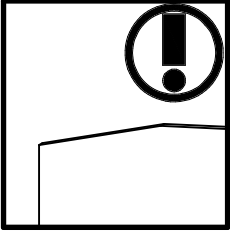
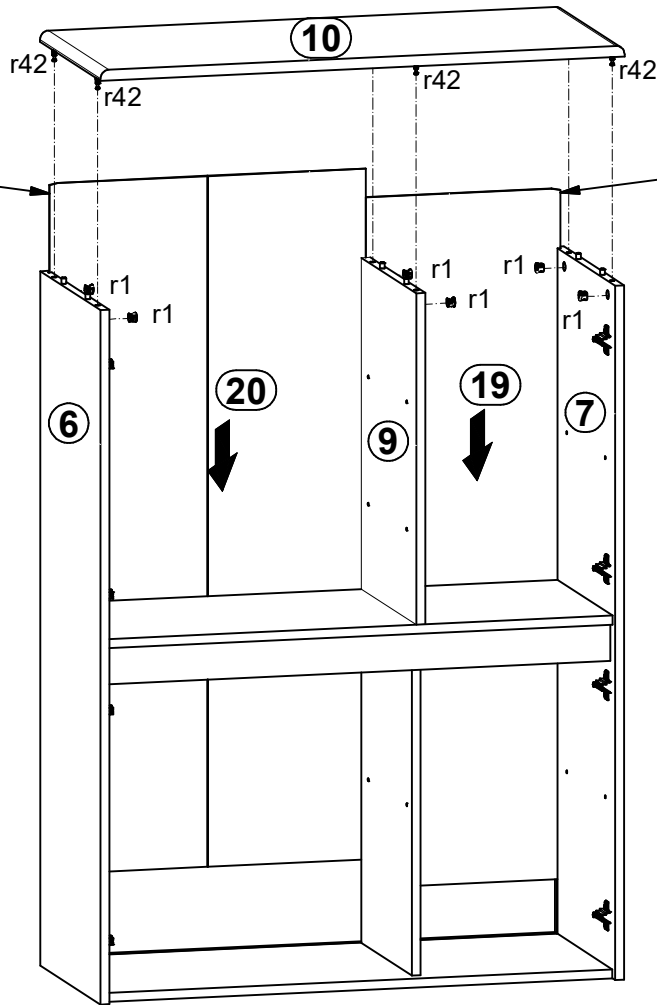

5

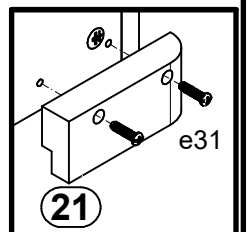
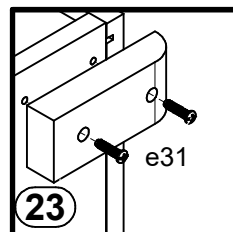
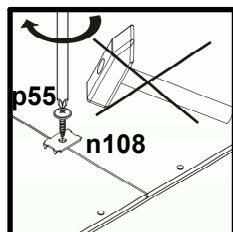
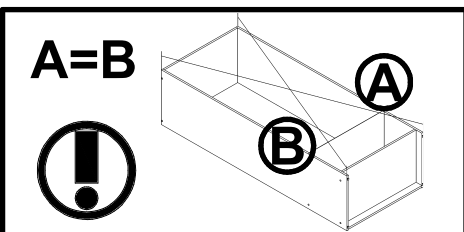
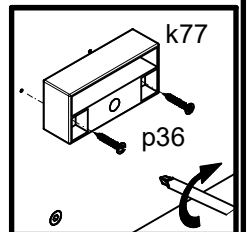
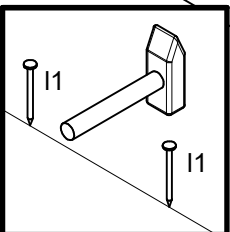
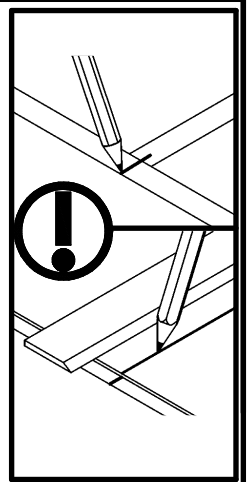
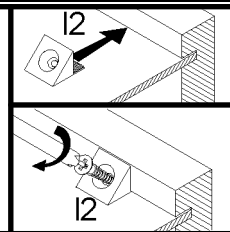
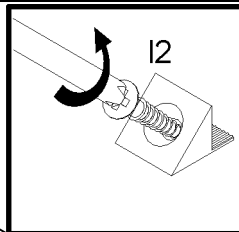
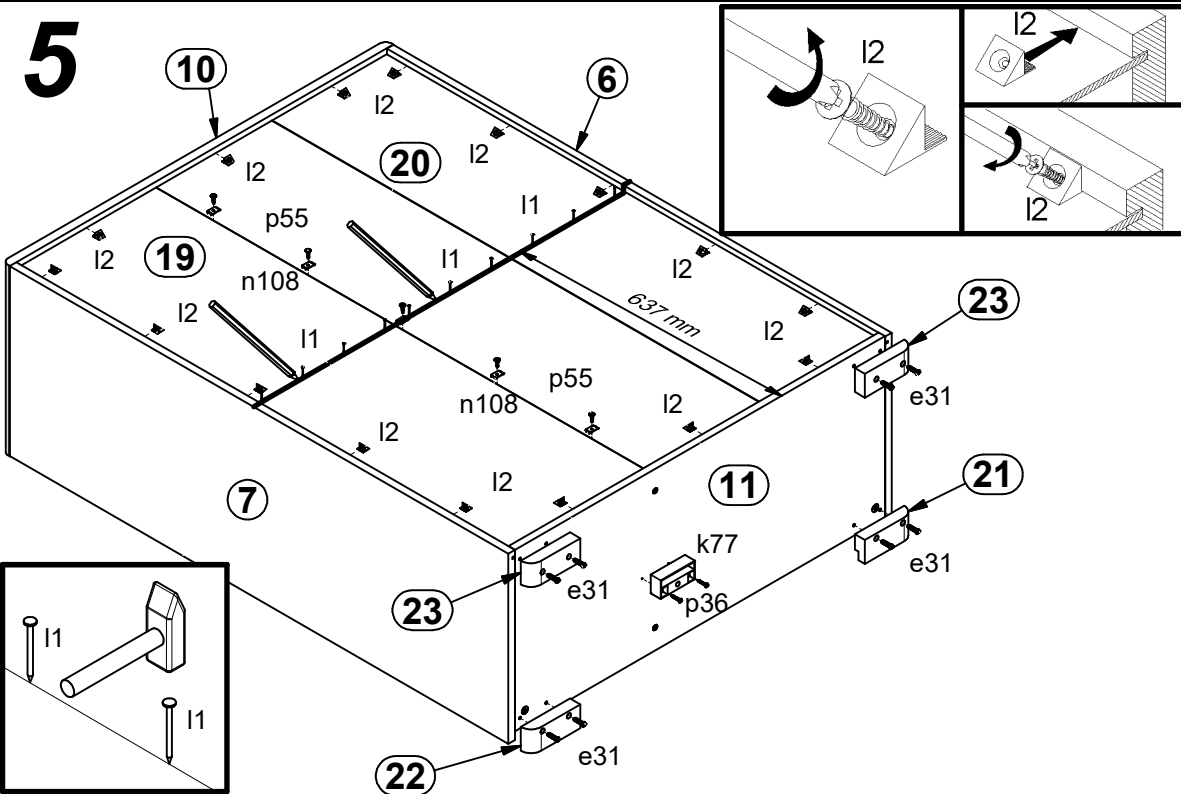

6

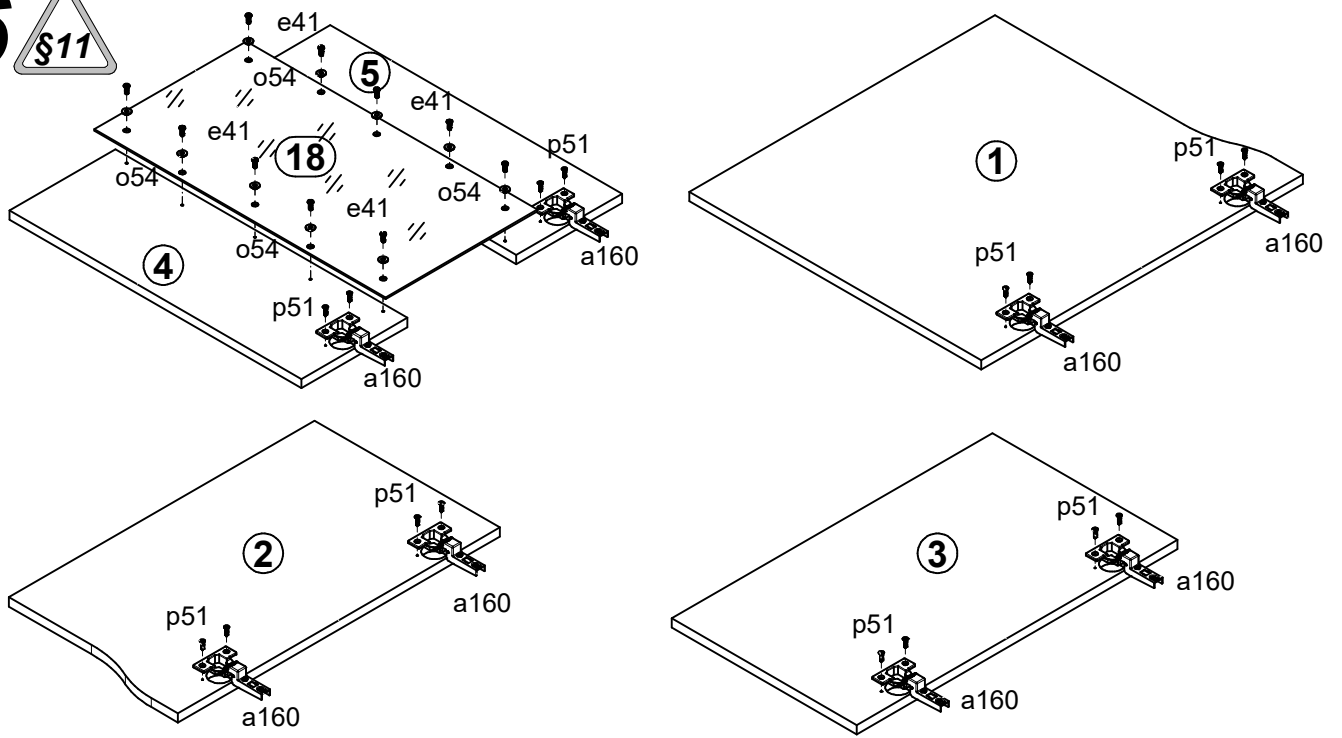

A=B

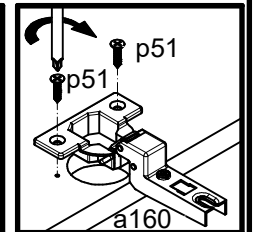
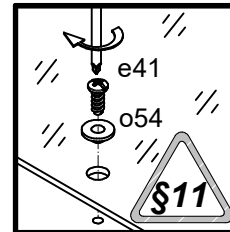

7

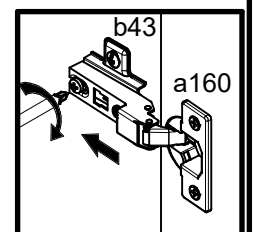
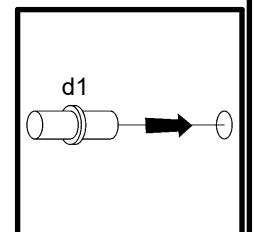
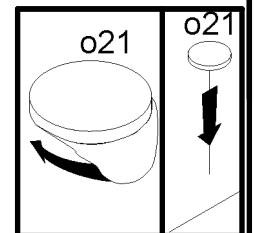
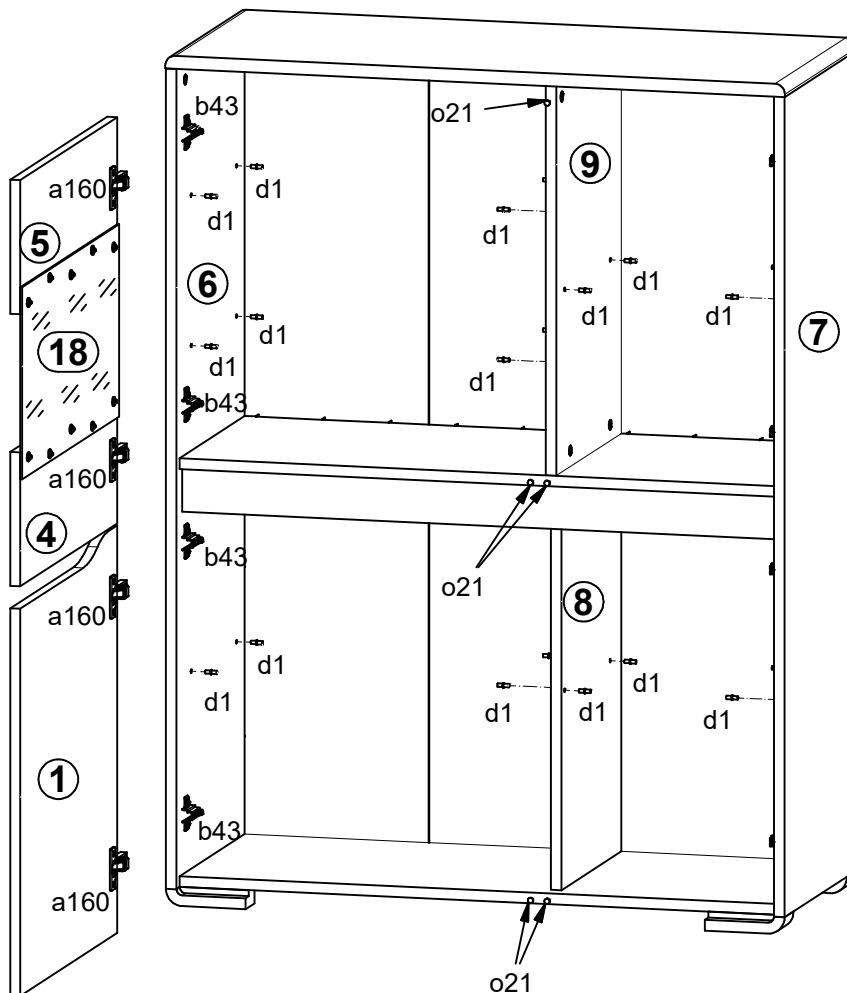

8

