

# FRAZA

A	B	C	D	
1	F13-111	1691	540	1/3
2	F13-112	1691	540	1/3
3	F13-310	991	536	2/3
4	F13-311	991	536	2/3
5	F13-403	991	70	2/3
6	F13-906	1615	1021	1/3
7	dr-984	984	30	2/3

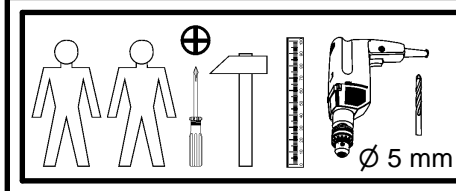

## F13-SZF2DL

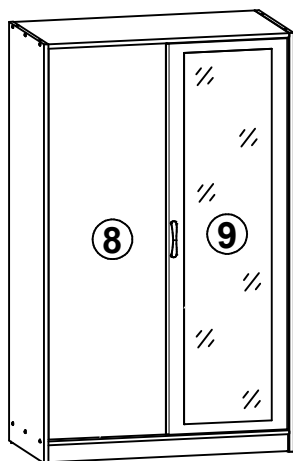

A	B	C	D	
8	F13-001	1580	500	3/3
9	F13-007	1580	500	3/3

## F13-SZF2D

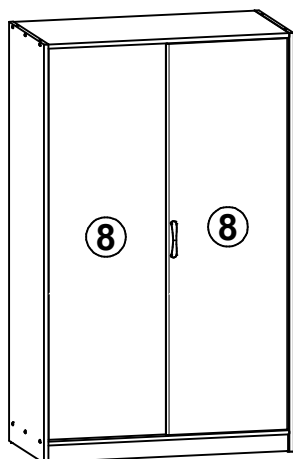

A	B	C	D	
8	F13-001	1580	500	3/3

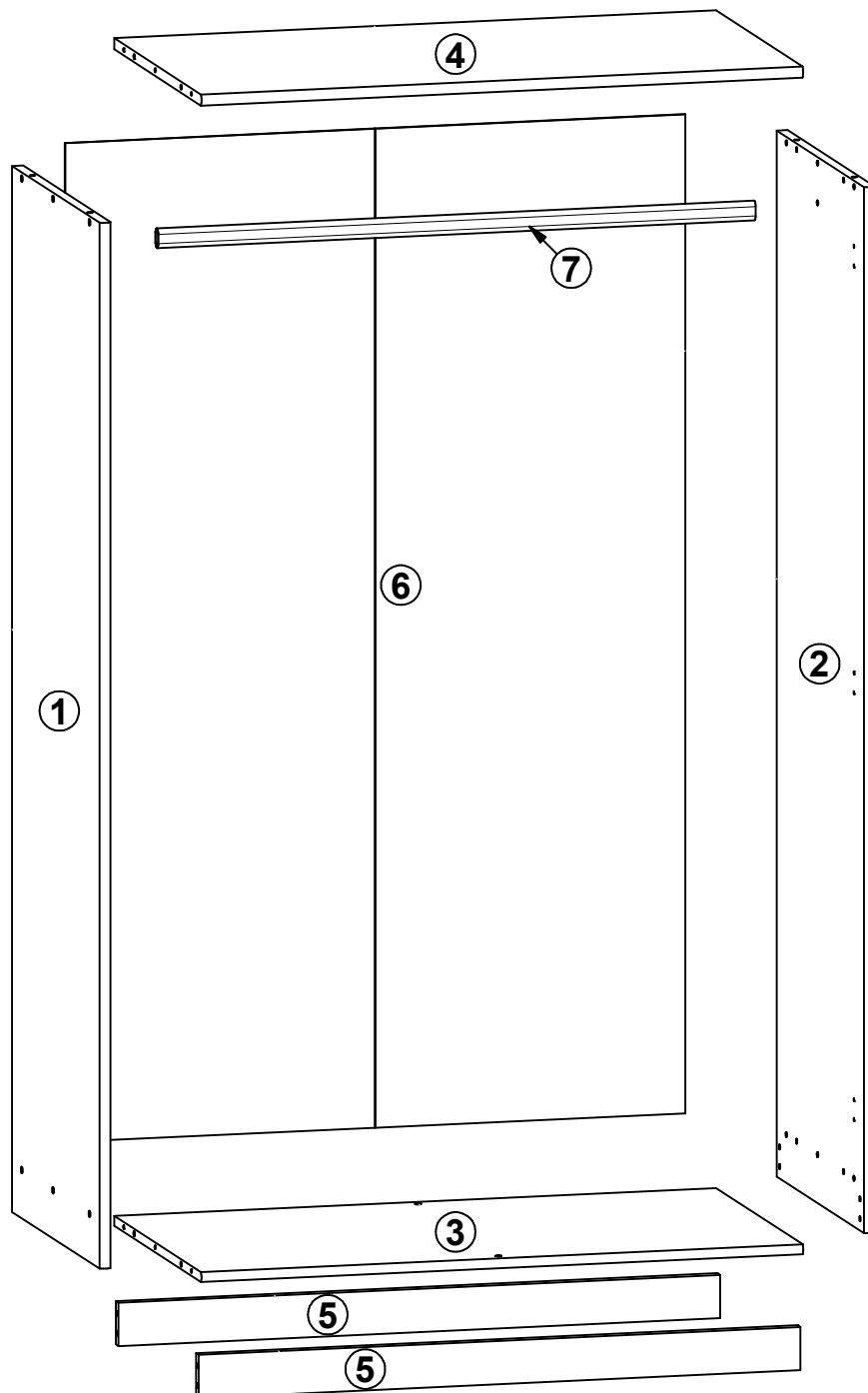

6x  a43	6x  b19	1x  c284	2x  d4 φ6,3x15 mm	14x  e1 φ7x50 mm	12x  e2 φ6,3x13 mm	16x  f1 φ8x30 mm	4x  k1	55x  l1
2x  n1	2x  p1 φ3,5x13 mm	12x  p51 φ3,5x15 mm	2x  p87 φ4x25 mm	14x  s1	1x  z1	1x  n26/1	1x  p38 φ3,5x16 mm	

1 

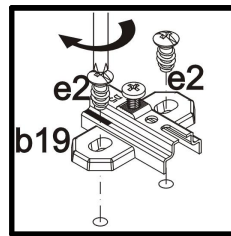
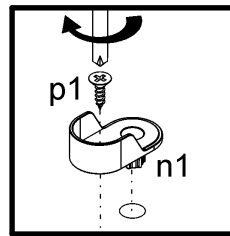
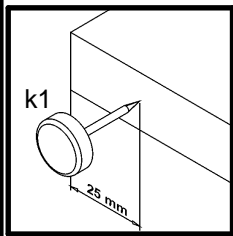
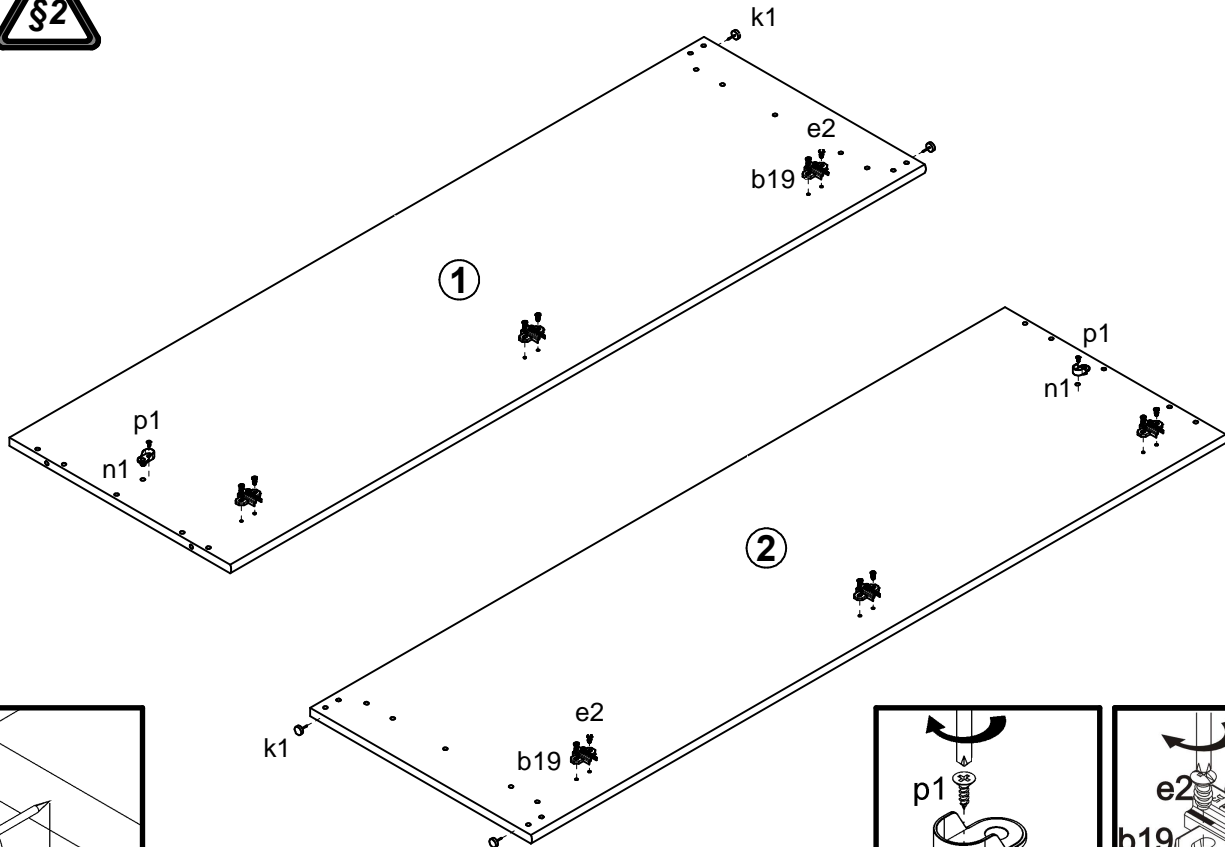

2 

