

A	B	C	D	
1	S68-006	220	978	3/3
2	S68-109	410	559	1/3
3	S68-110	410	559	1/3
4	S68-111	410	559	1/3
5	S68-205	2082	560	1/3
6	S68-409	984	539	2/3
7	S68-906	946	485	2/3
8	ZS1-1533	935	140	2/3
9	ZS1-1534	935	140	2/3
10	ZS1-1535	500	140	2/3
11	S68-902	448	1022	2/3

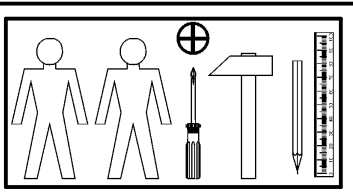

2x 928mm c223\4	12x φ6x13 mm e3	16x φ5x50 mm e32	20x φ8x30 mm f1	6x M4x20 mm j1	6x k1	75x l1	8x φ2,5x13 mm p15	4x φ3,5x16 mm p25
10x φ8x26 mm p97	30x φ1,5x12mm #16 r1	6x φ2,1x10mm r31	30x r42	9x ø15 s51	2x 475 mm t32	2x 500 mm w26\CL	2x 500 mm w26\CR	2x 500 mm w26\DL
2x 500 mm w26\DR								

1

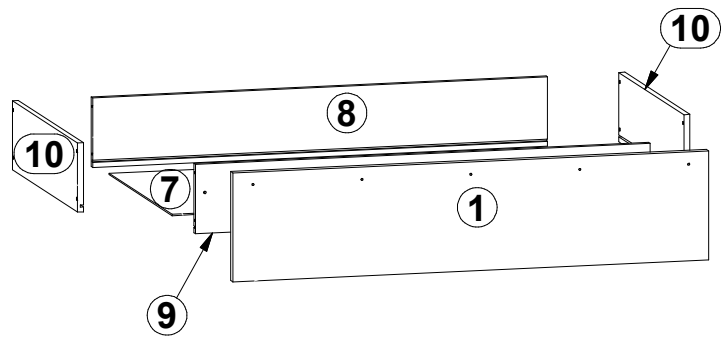
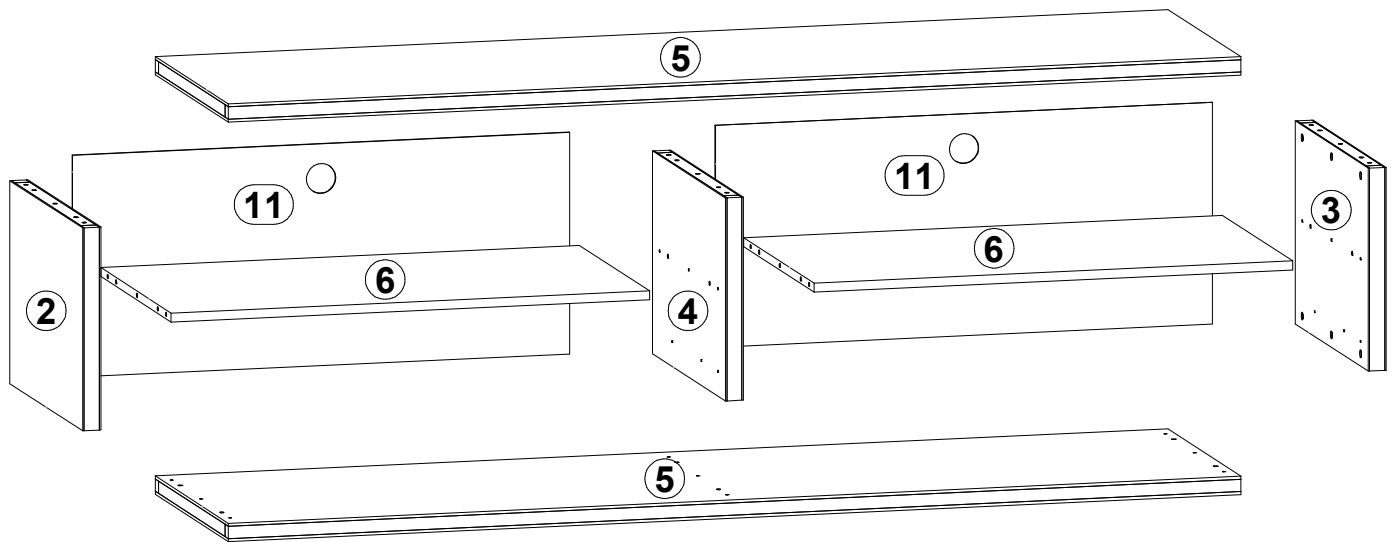
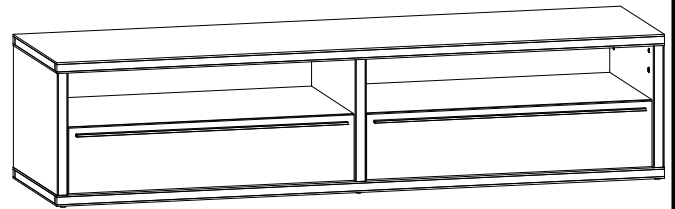
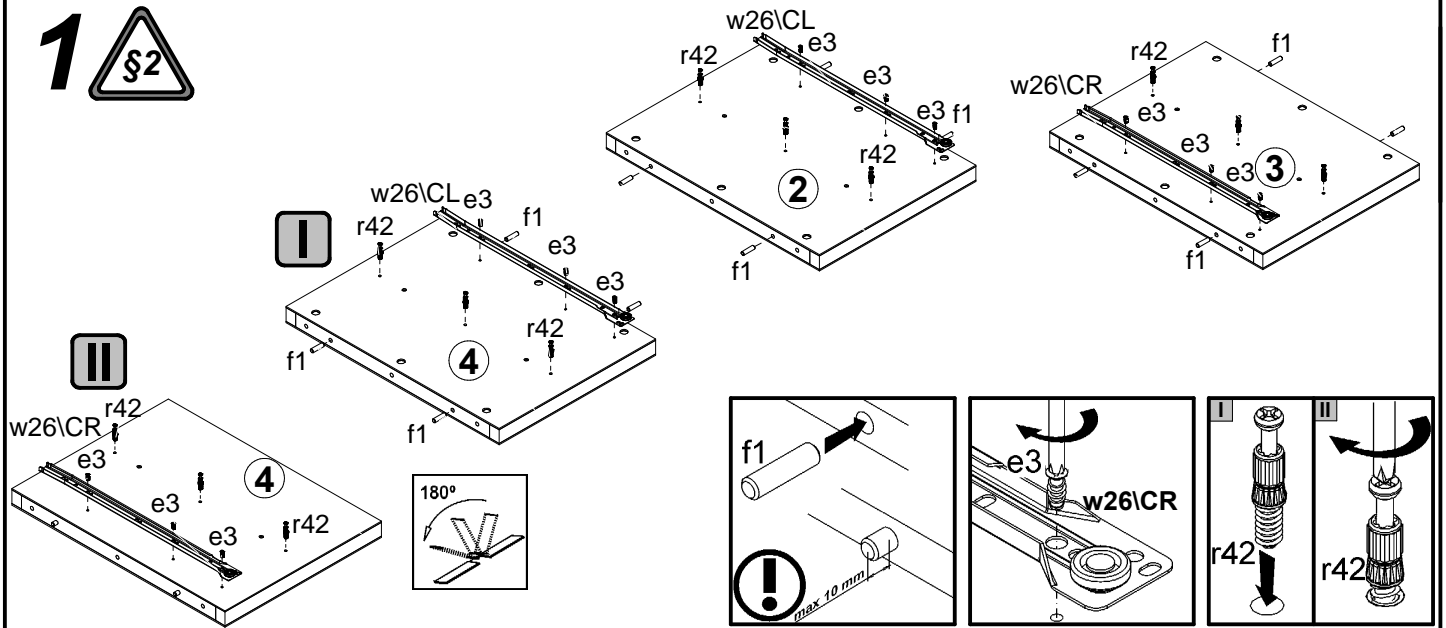

2

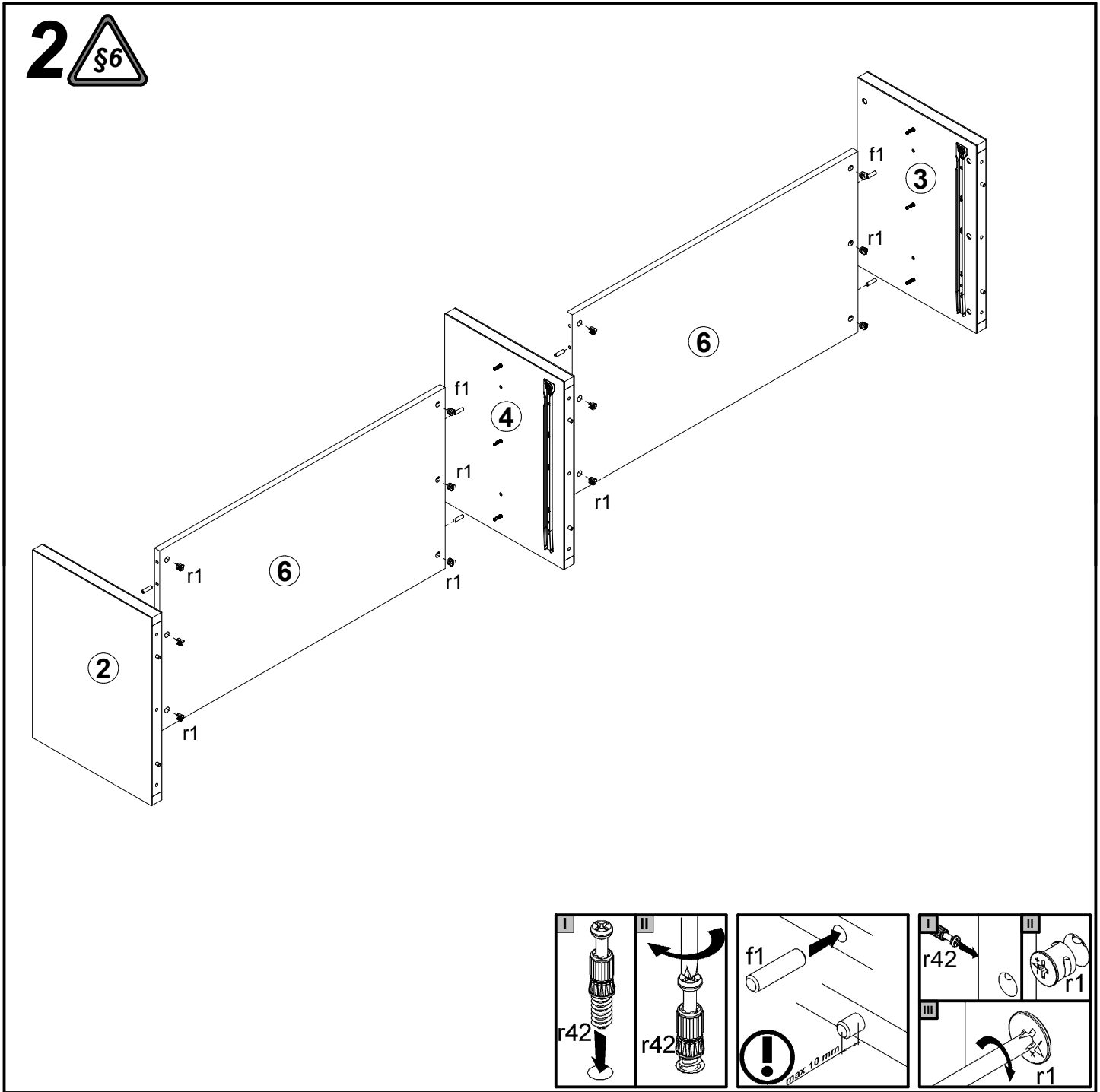

3

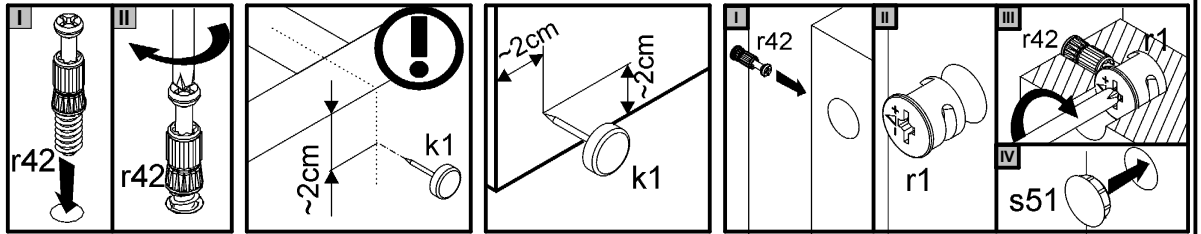
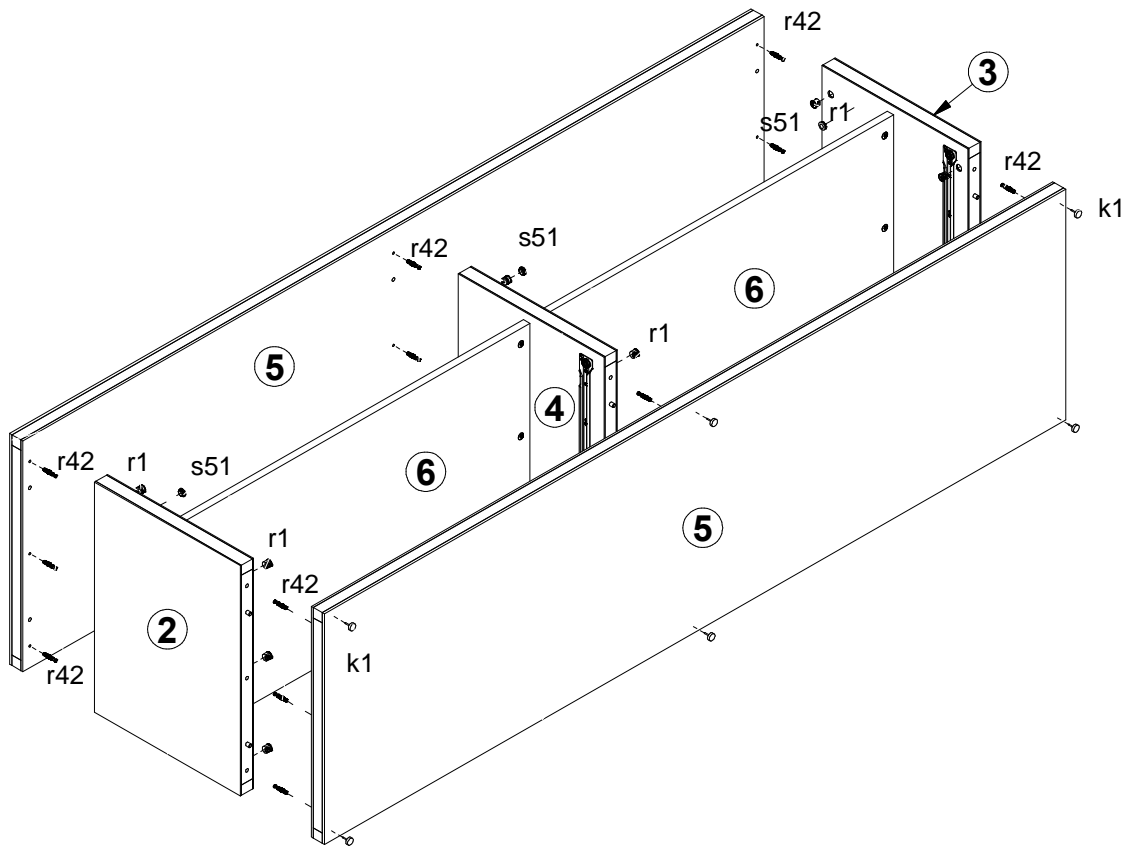

4

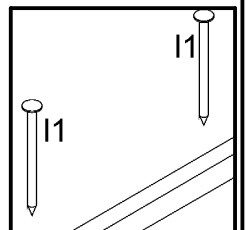
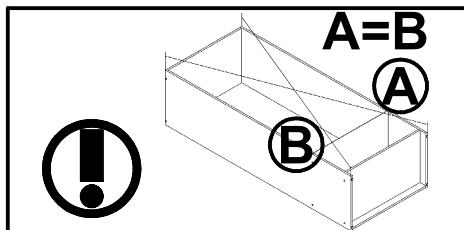
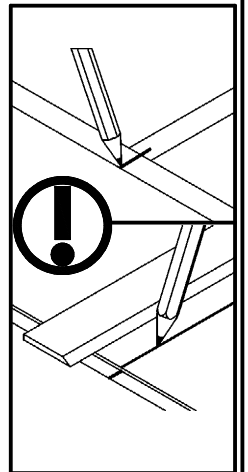
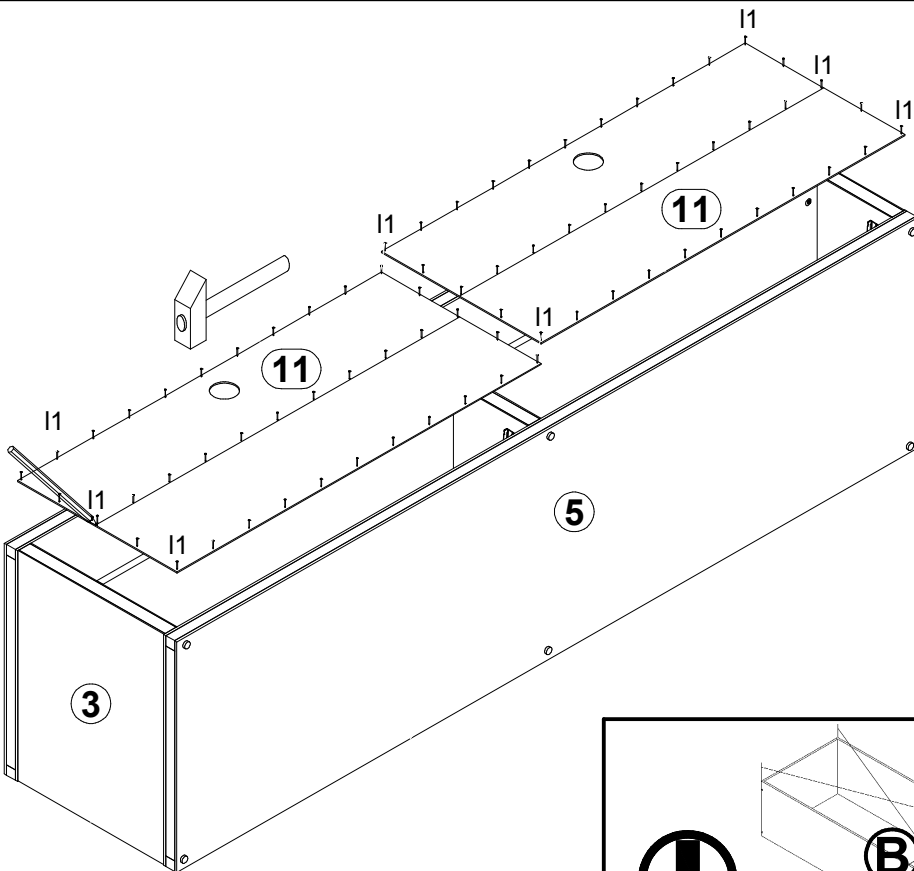

5

I

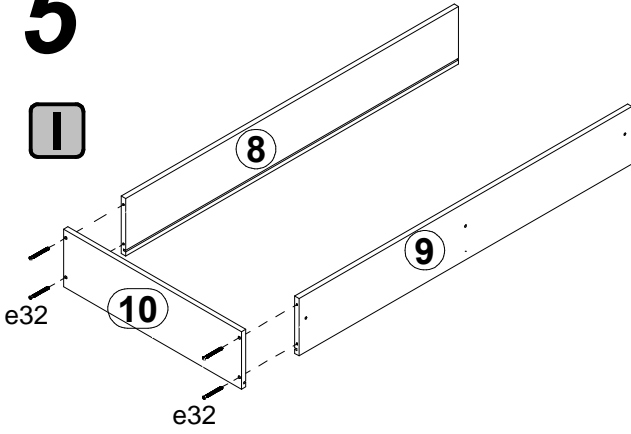

II

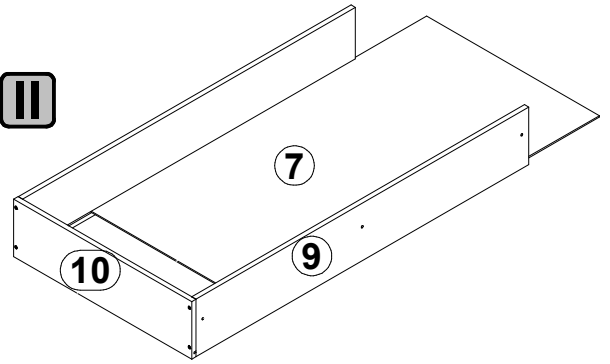

III

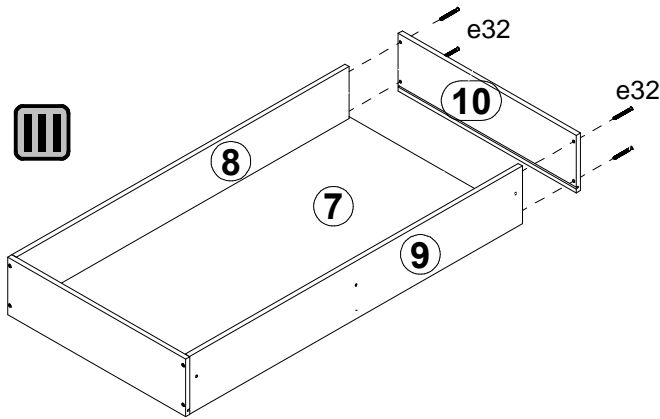

IV

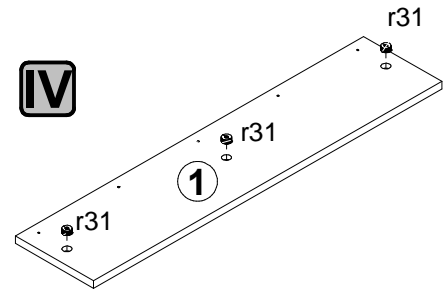

V

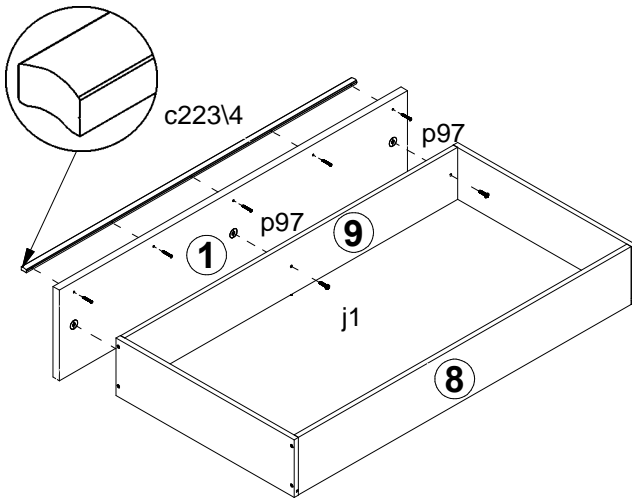

VI

