

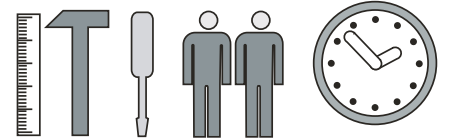

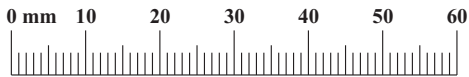

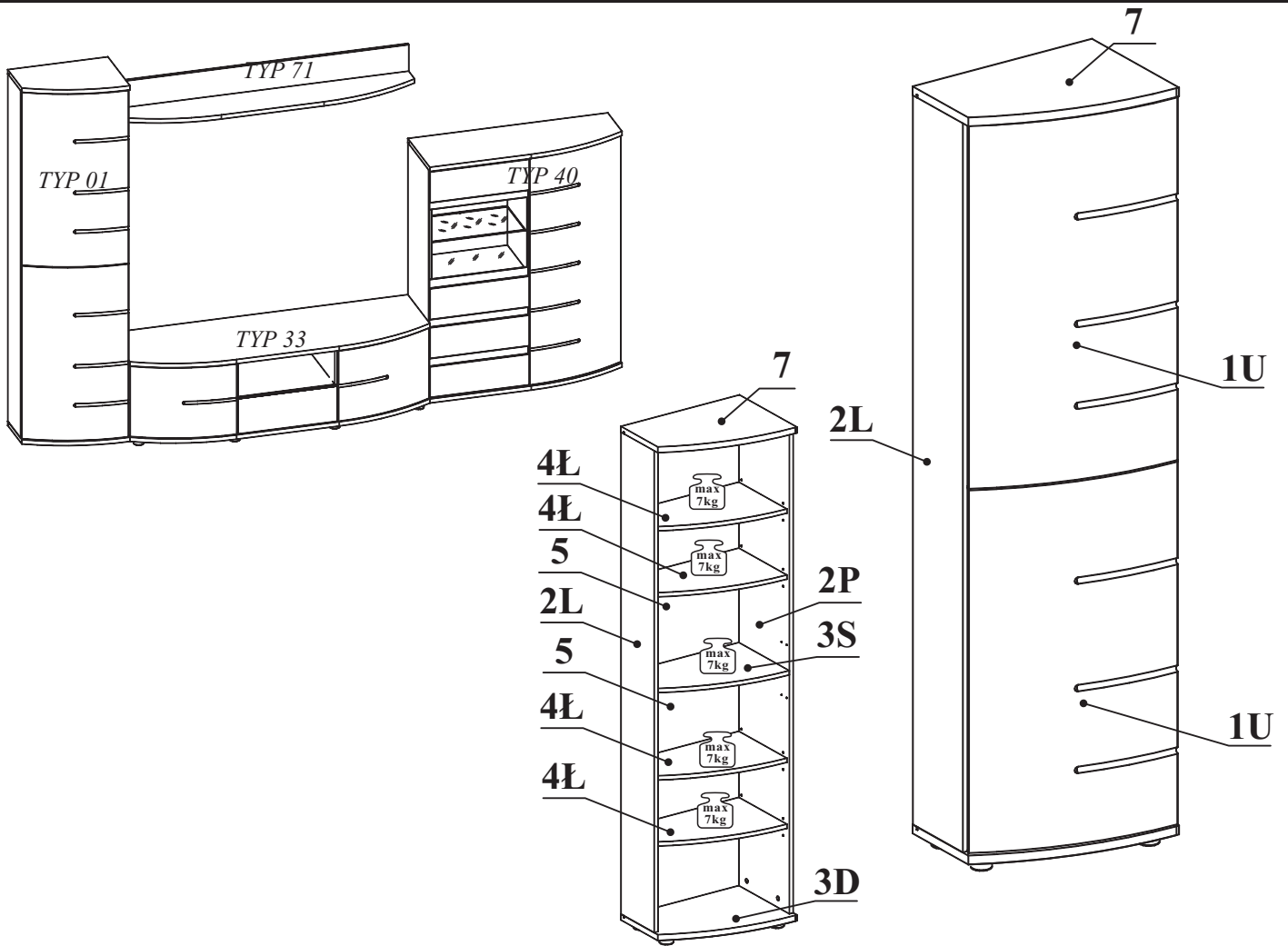

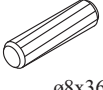

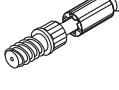

Olivia 24 SRW O1

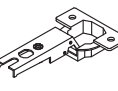
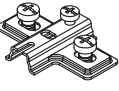

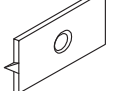
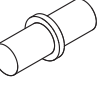
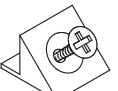
90 min

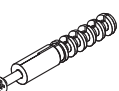
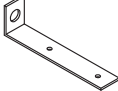
A1 X12  ø8x36	B4 X9 	B5 X9  ø15x12	G5 X9 	G2 X1 	D11 X4  USØ3,5x25
E1 X6  H=0	E2 X6  H=0	ST2 X4 	D9 X3  USØ3x20	G16 X3 	G7 X16 
S1 X14 	D10 X18  USØ3,5x13	KR1 X1 	L1 X1 	T2 X2  20x14	

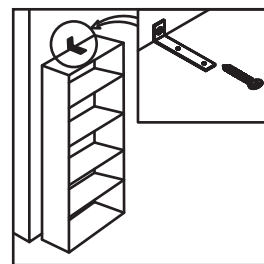
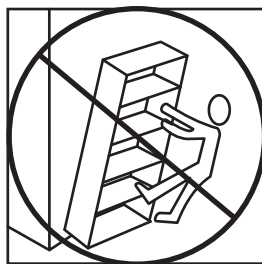
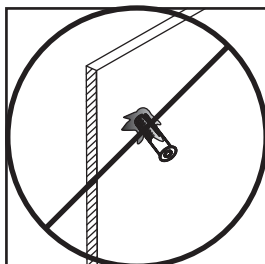
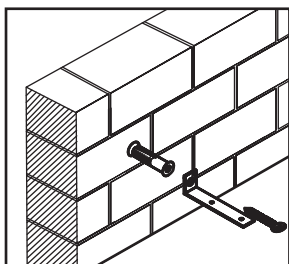
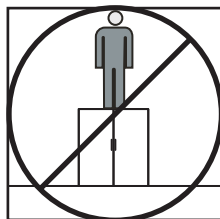
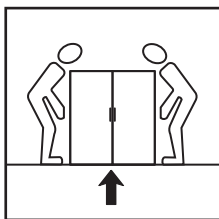
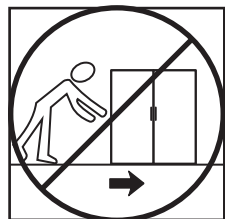
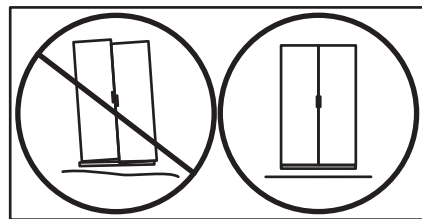
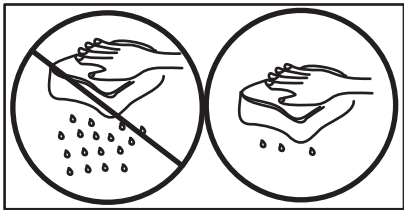
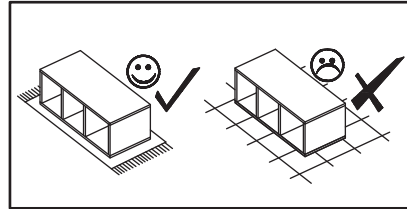
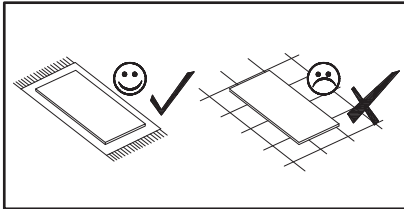
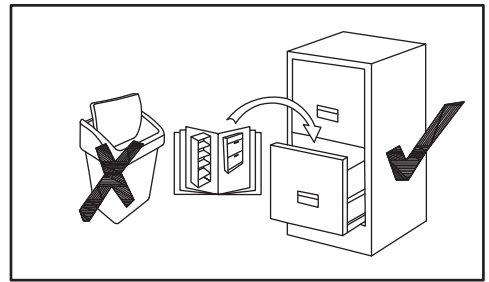
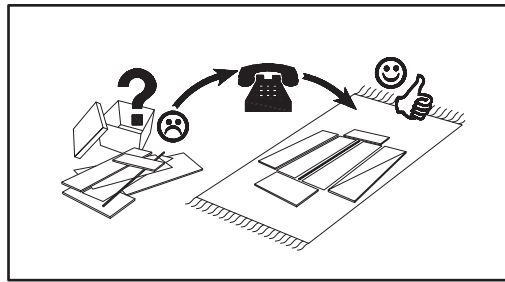
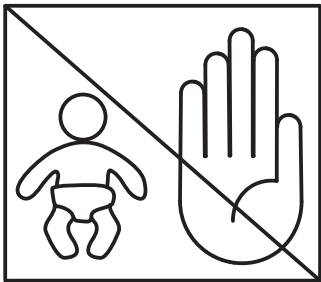

TYPE-01

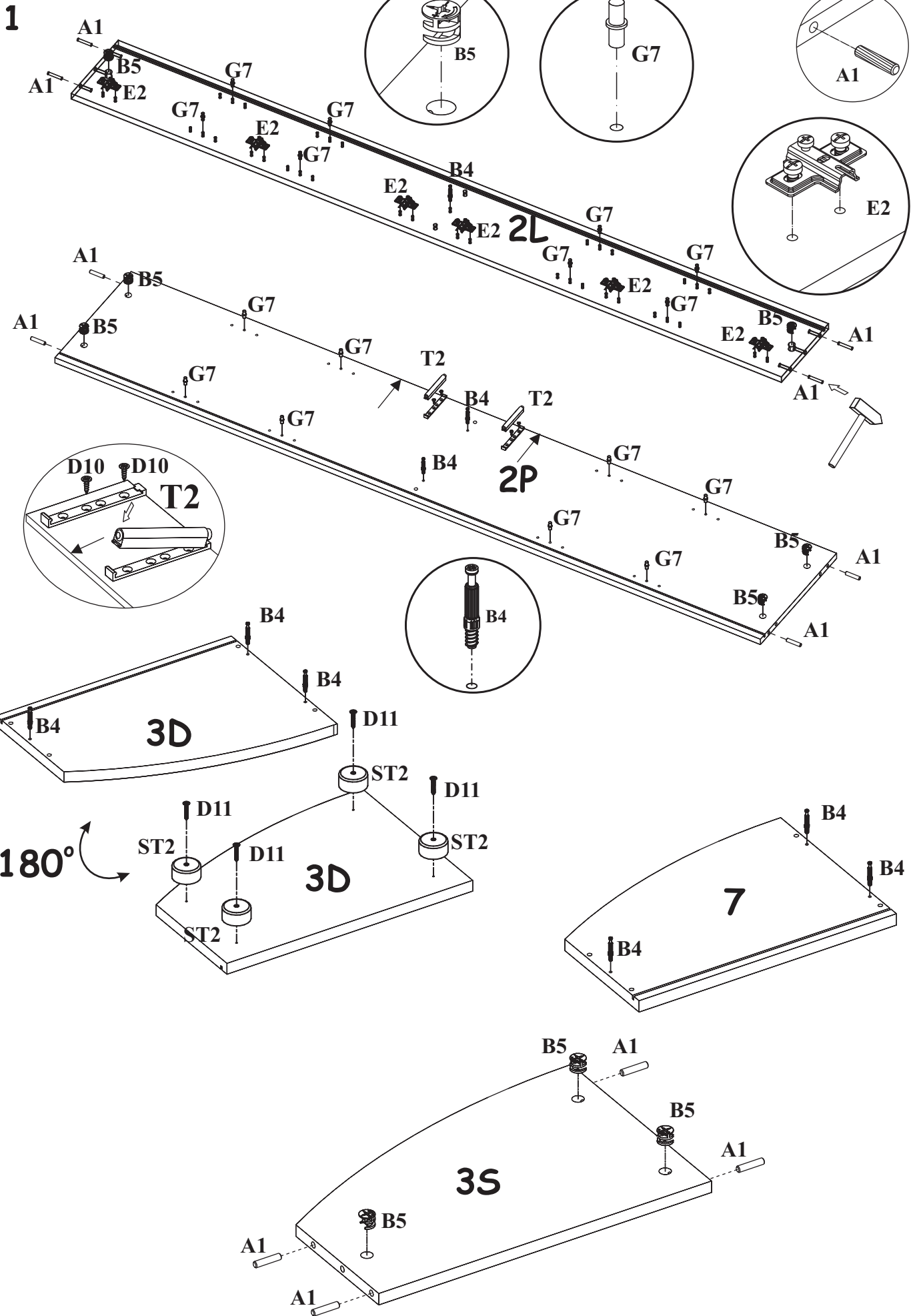

2

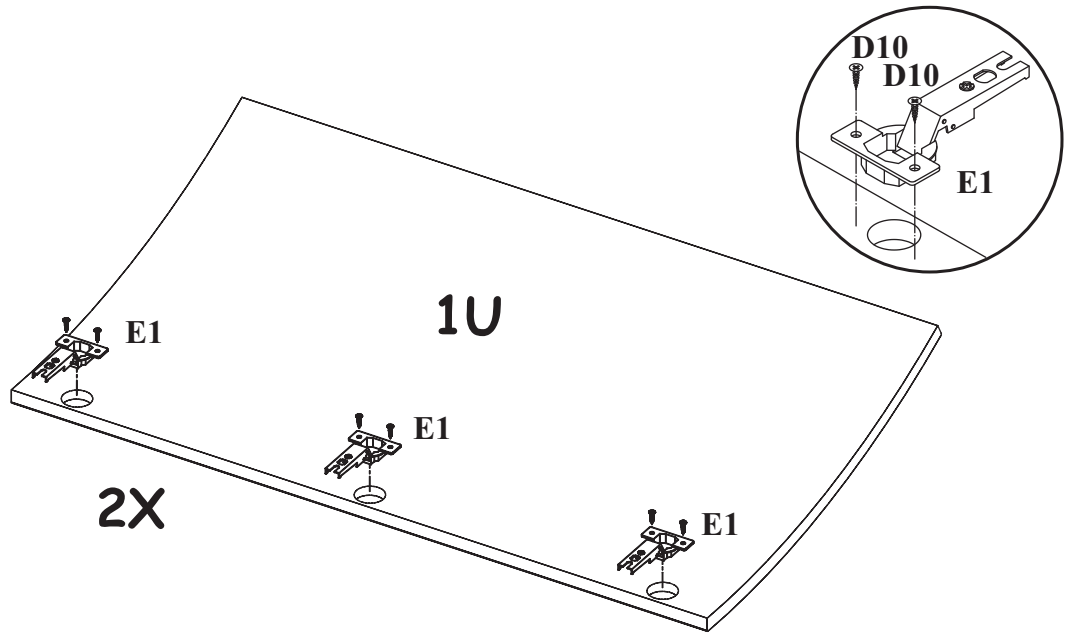

3

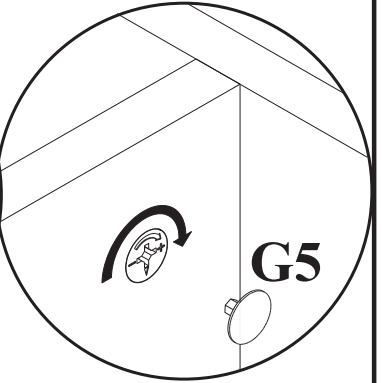
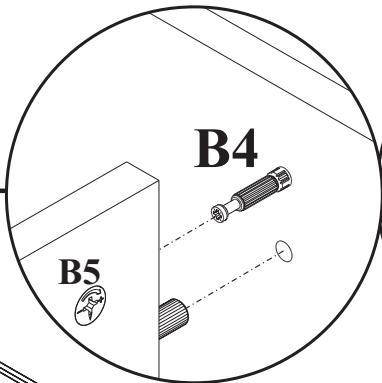
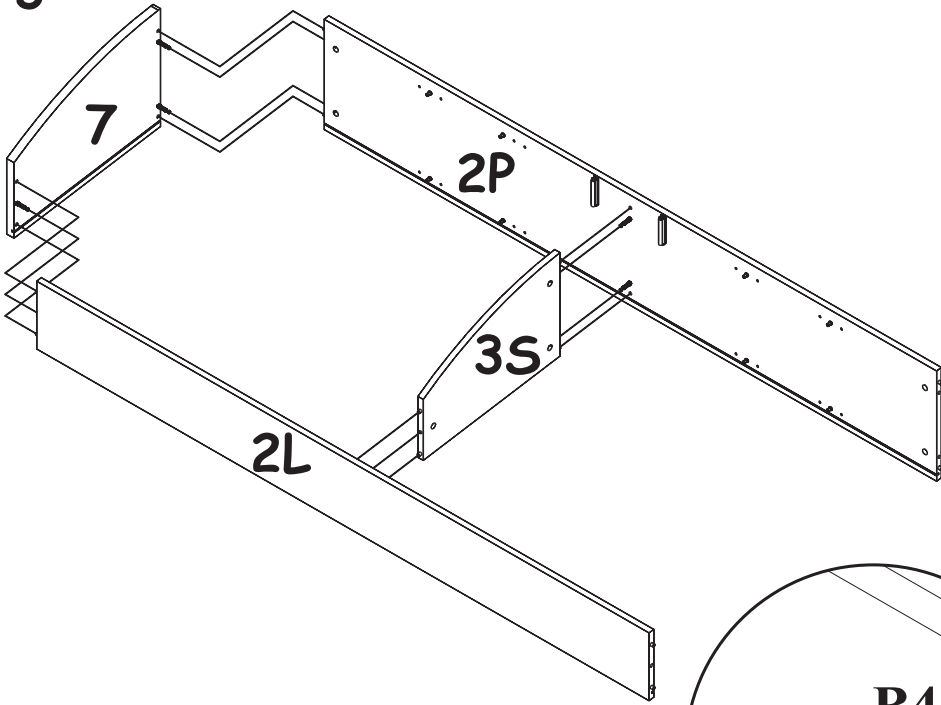

4

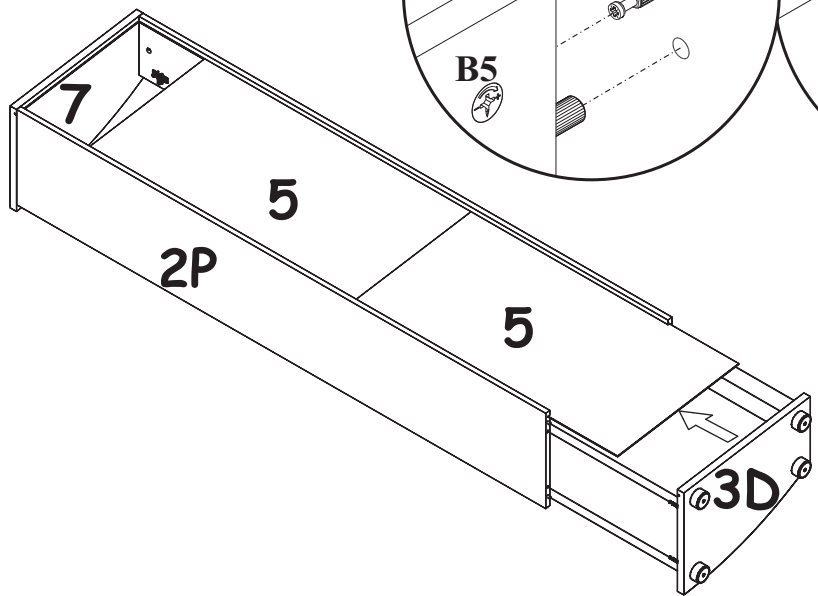

TYPE-01

5

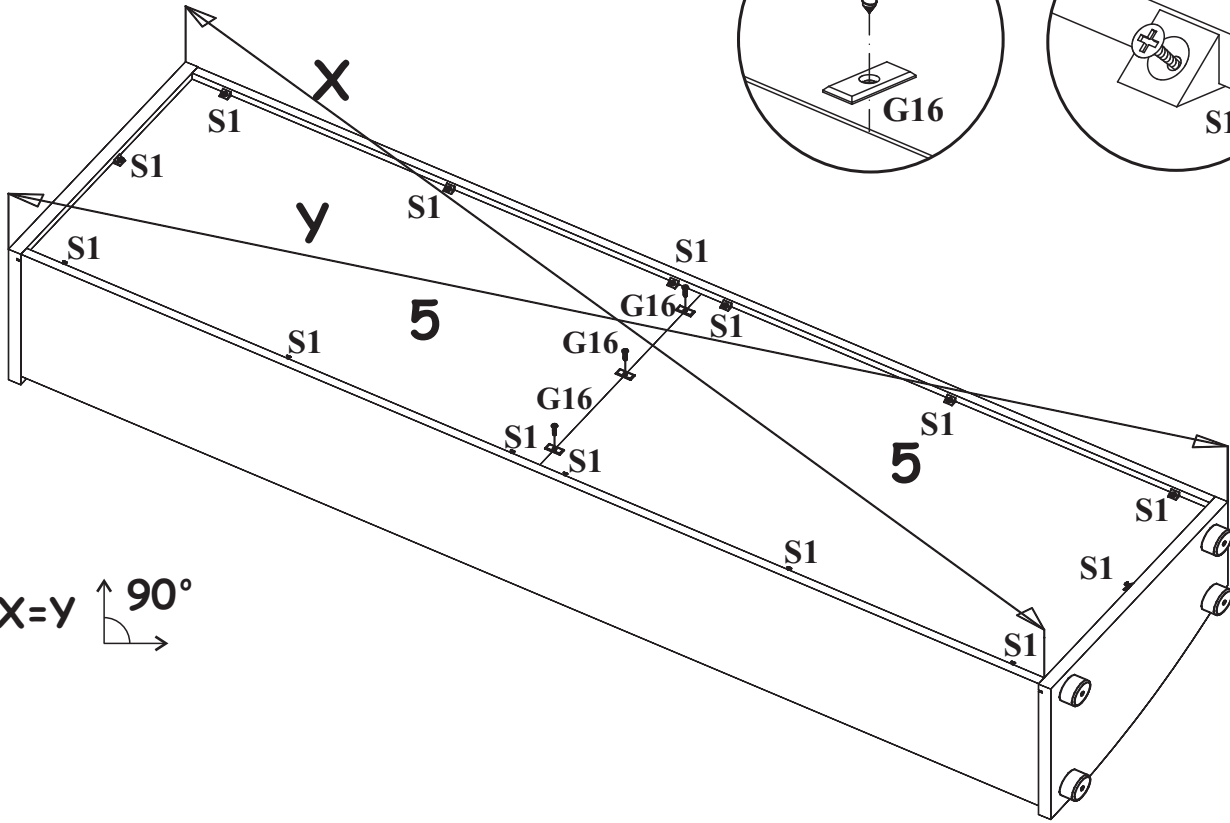

$X=y$ \uparrow 90°

6

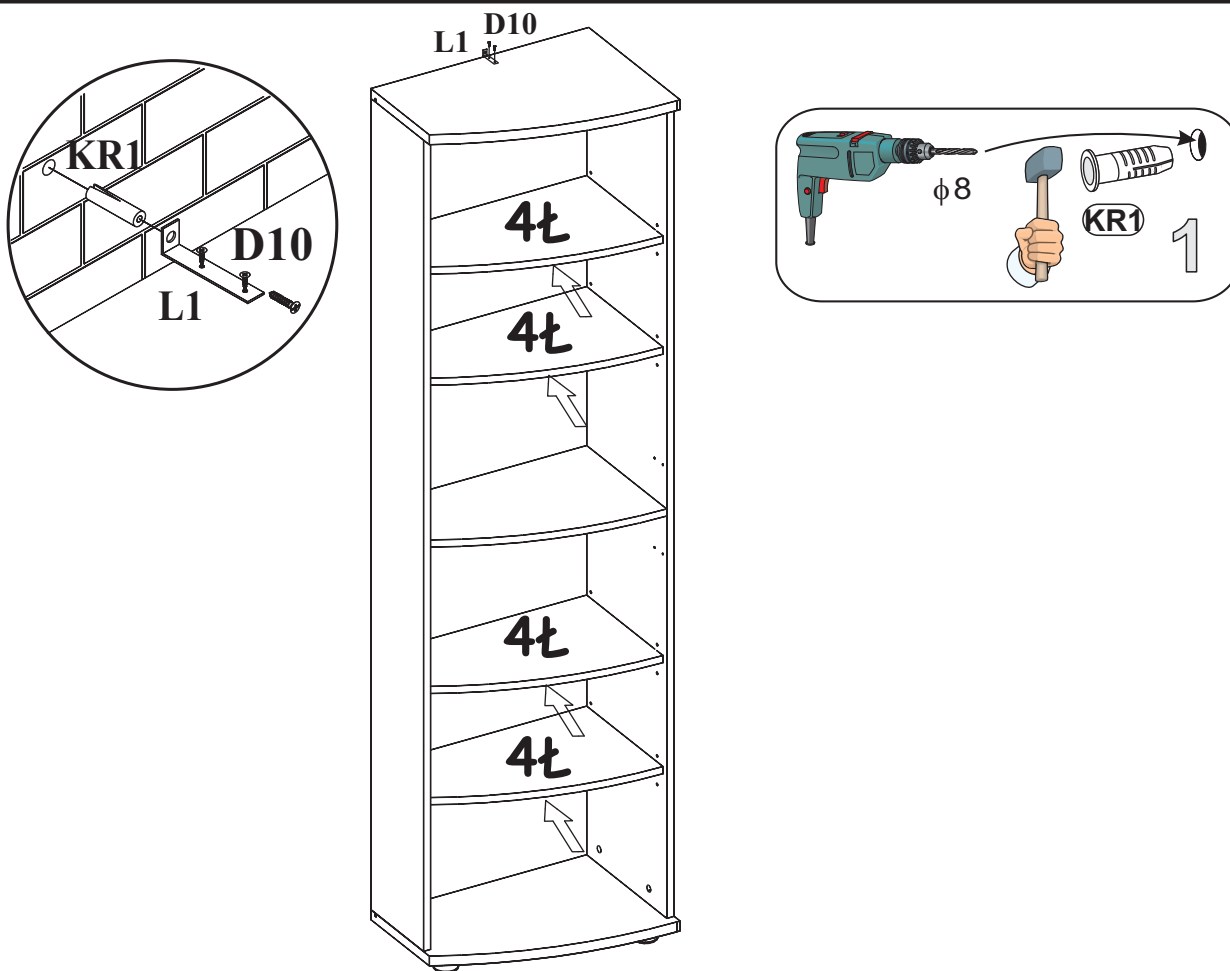

7

