



LE TRI + FACILE



FR

Pensez à donner ou recycler.



ou



ou



<https://quefairedemesdechets.fr>

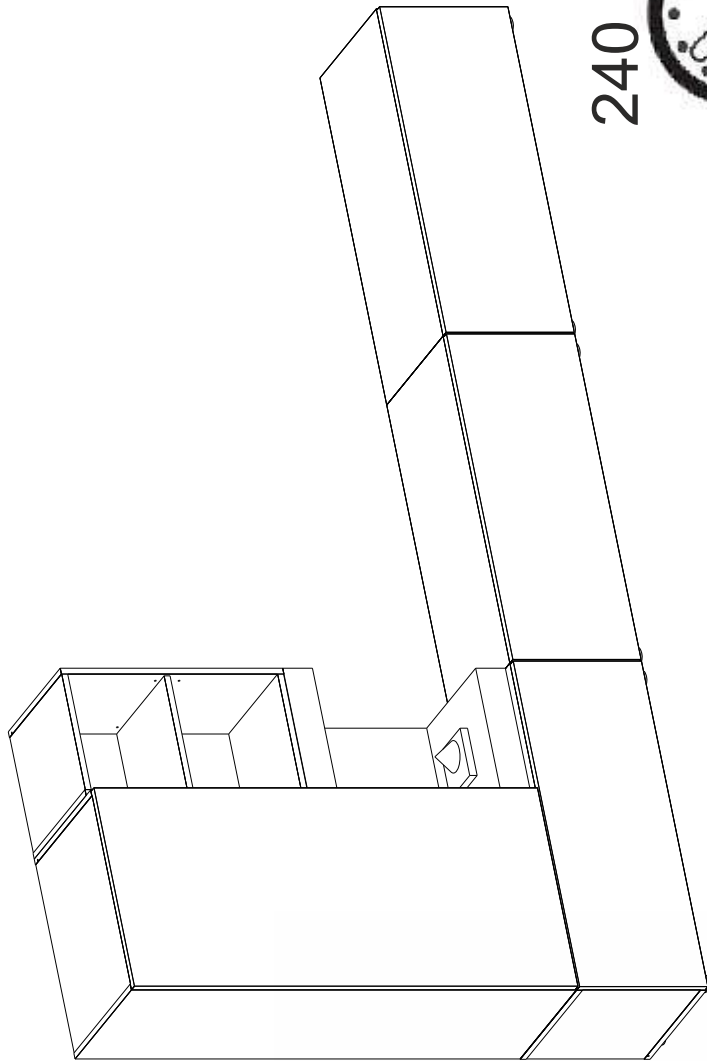
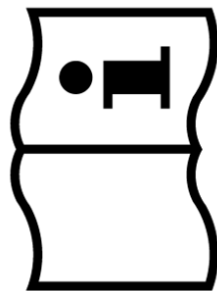

240 min

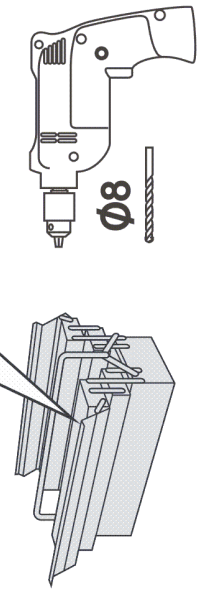
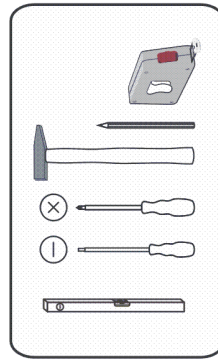
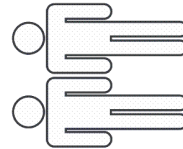
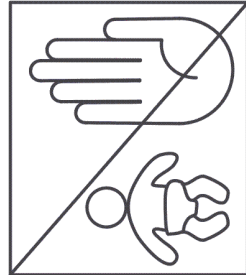
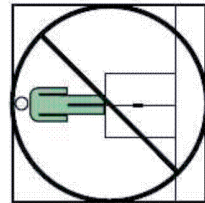
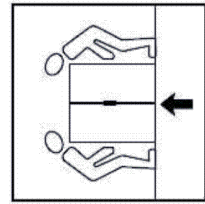
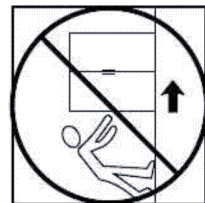
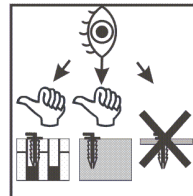
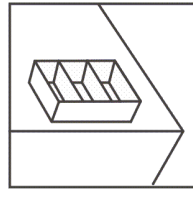
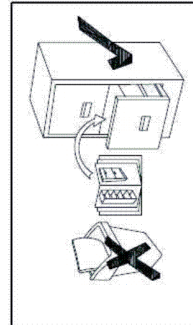
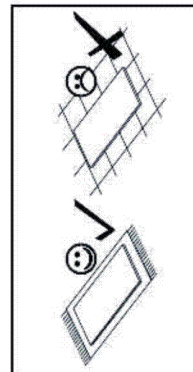

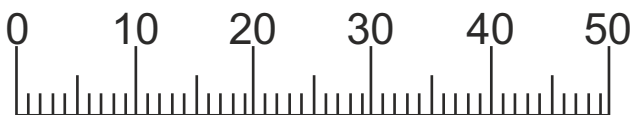
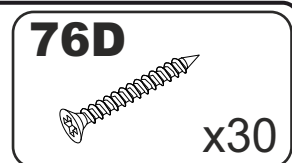
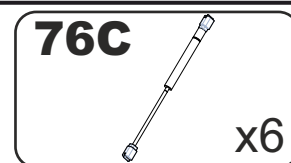
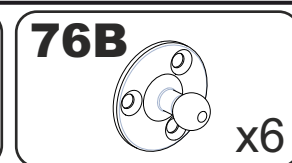
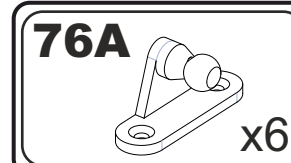
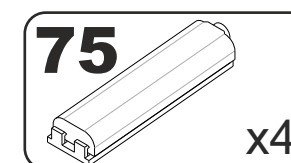
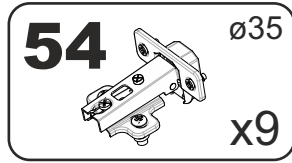
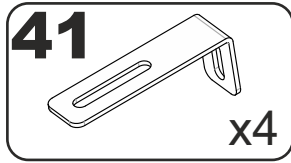
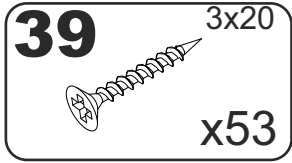
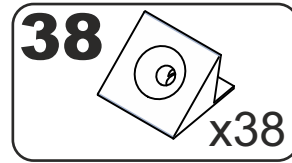
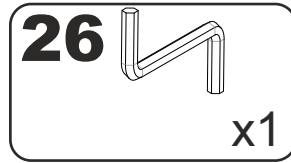
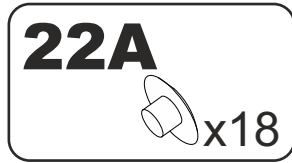
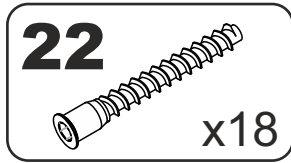
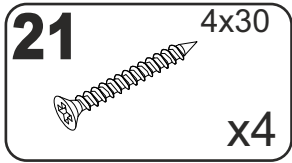
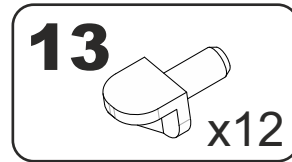
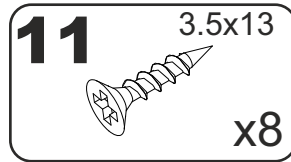
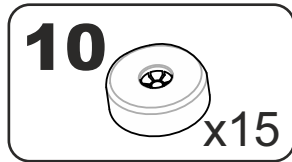
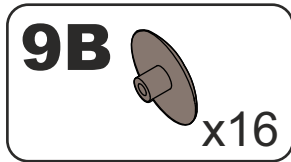
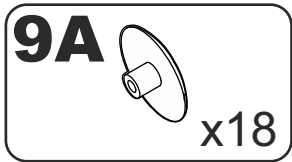
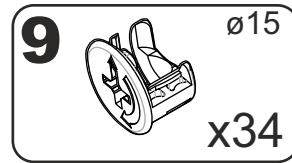
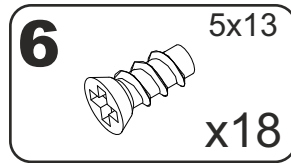
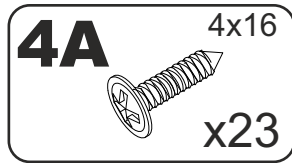
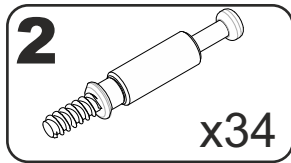
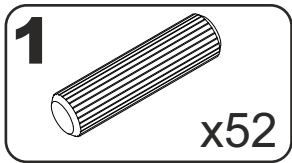
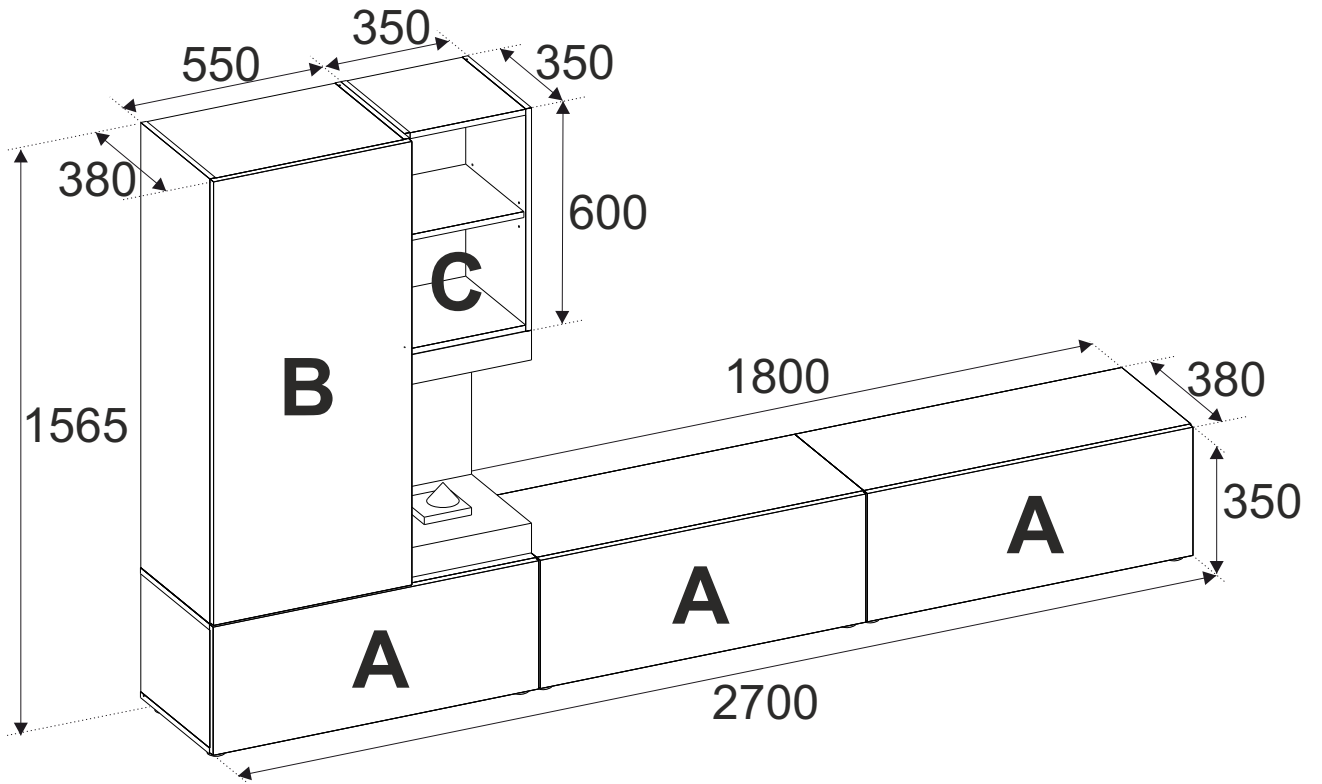
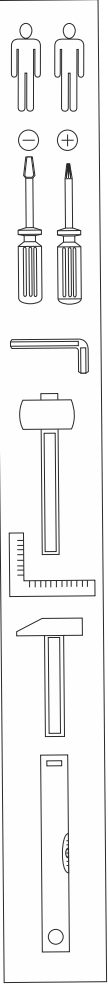

# A

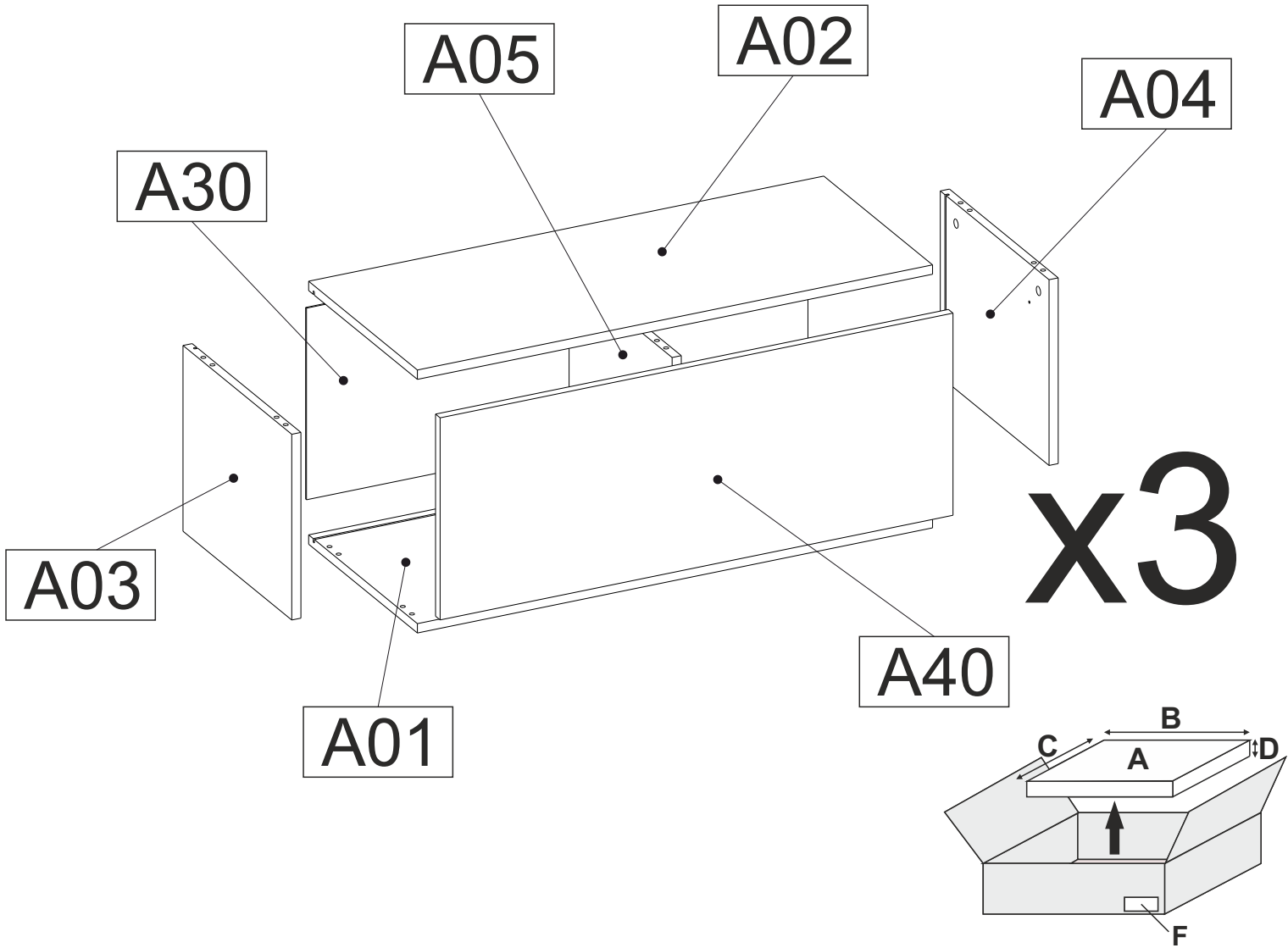

A	B_(mm)	C_(mm)	D_(mm)	E	F
A01	900	380	16	1	2 3
A02	900	380	16	1	3 3
A03	318	380	16	1	2 3
A04	318	380	16	1	2 3
A05	318	360	16	1	2 3
A30	876	328	3	1	2 3
A40	896	346	16	1	3 3

# 1

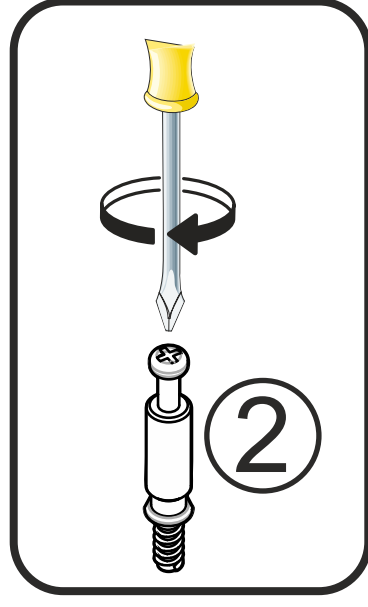
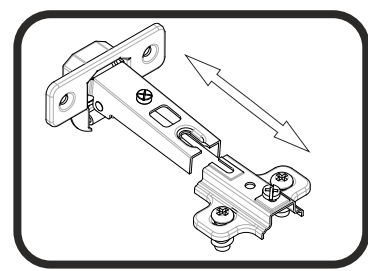
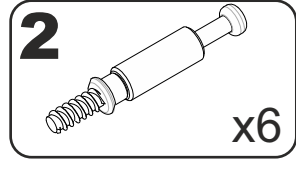
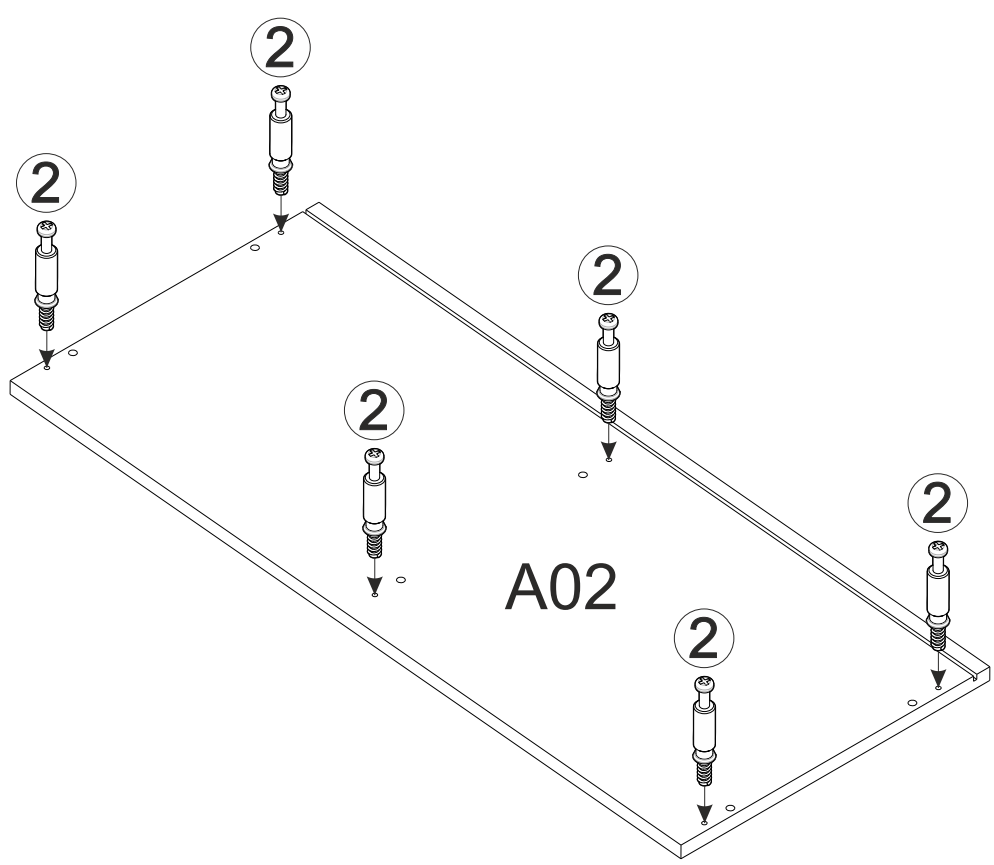

# 2

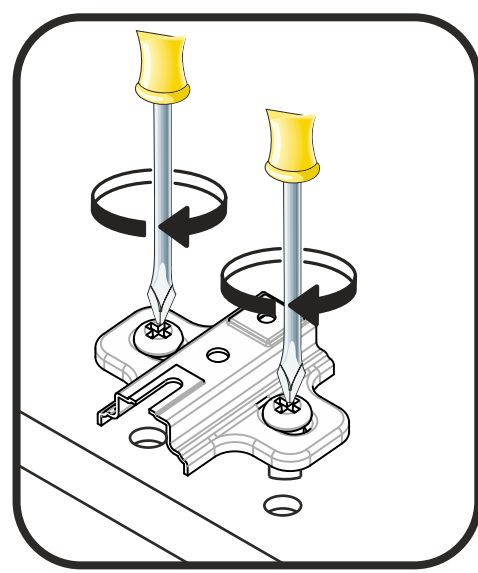
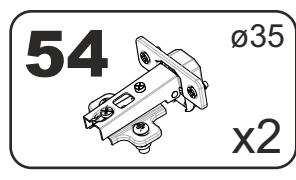
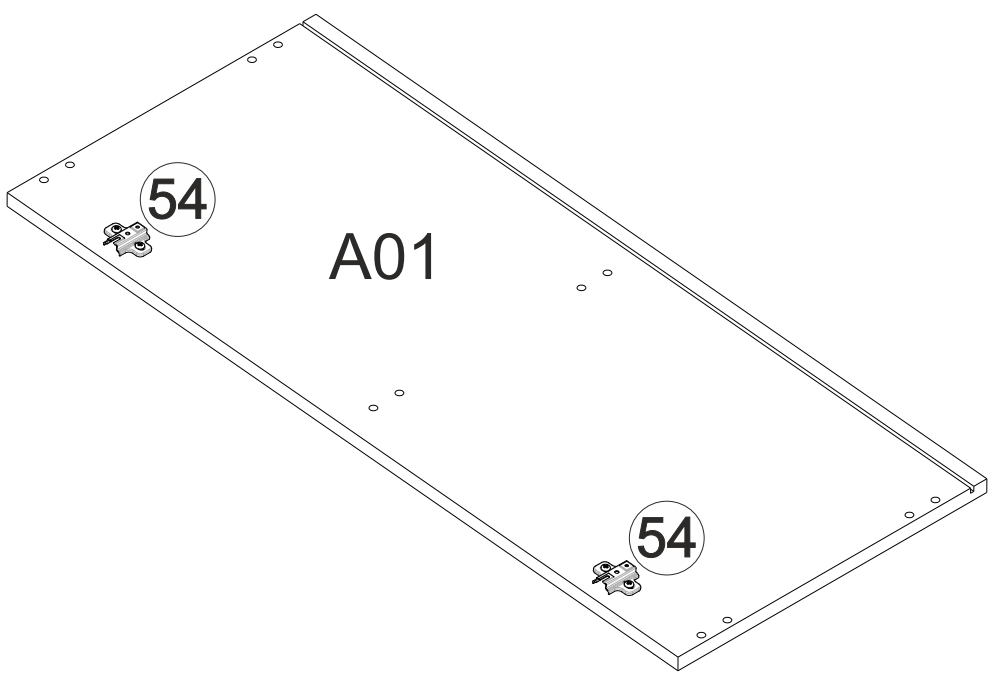

# 3

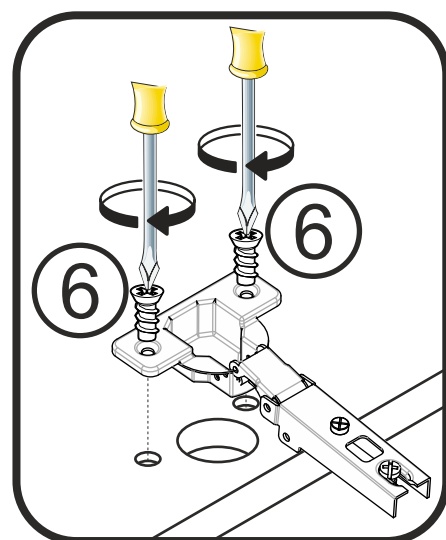
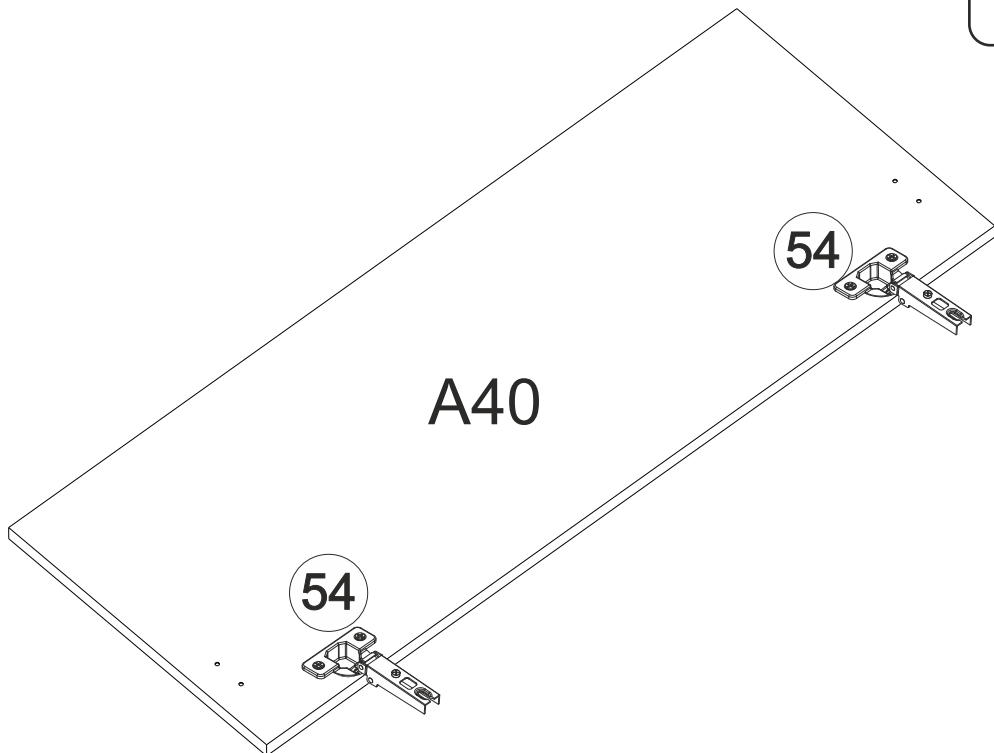
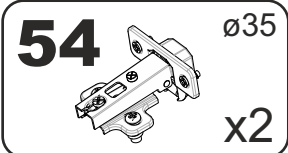
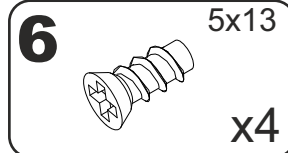

# 4

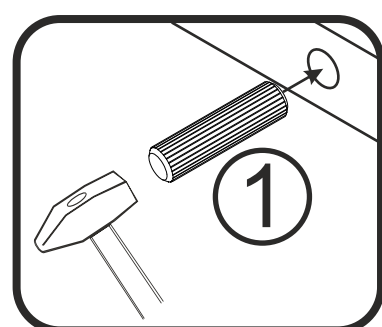
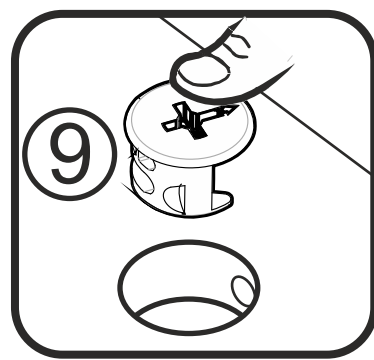
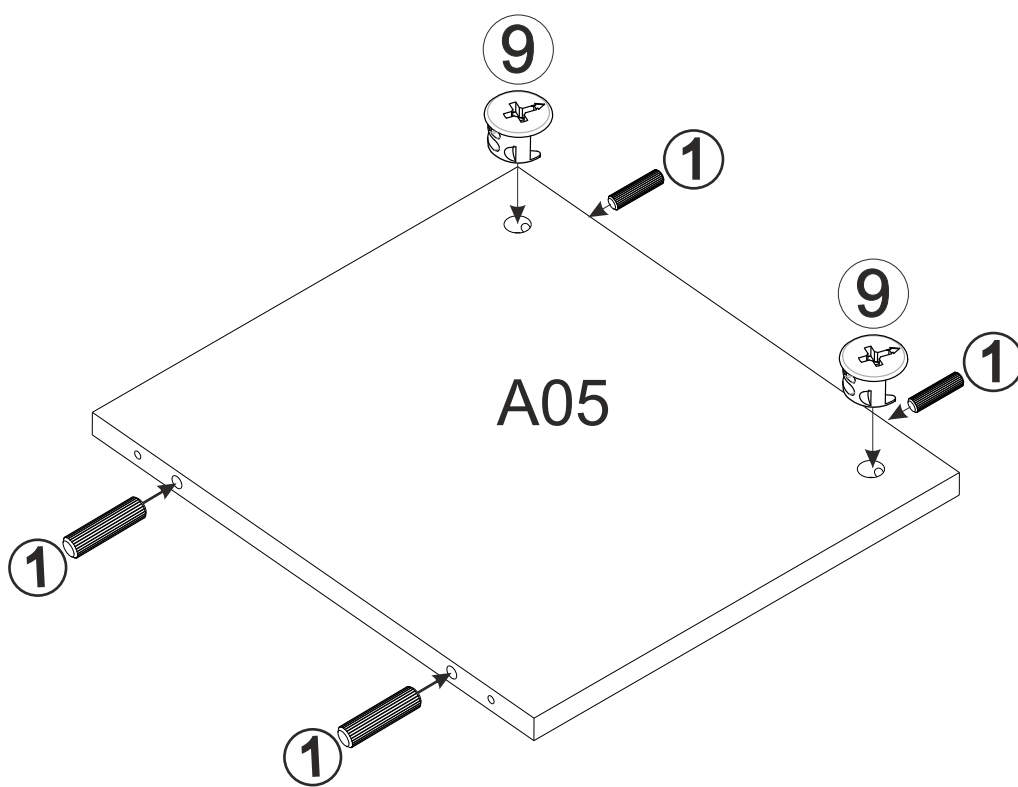
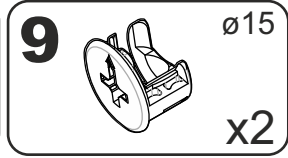
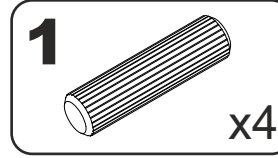

# 5

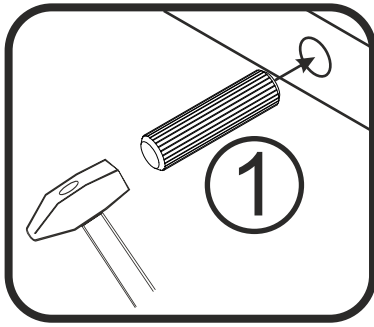
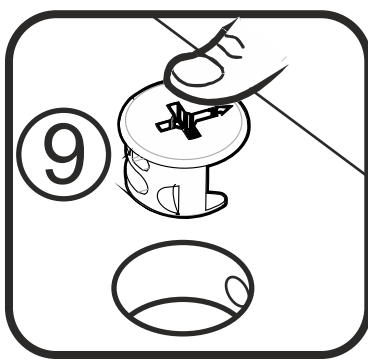
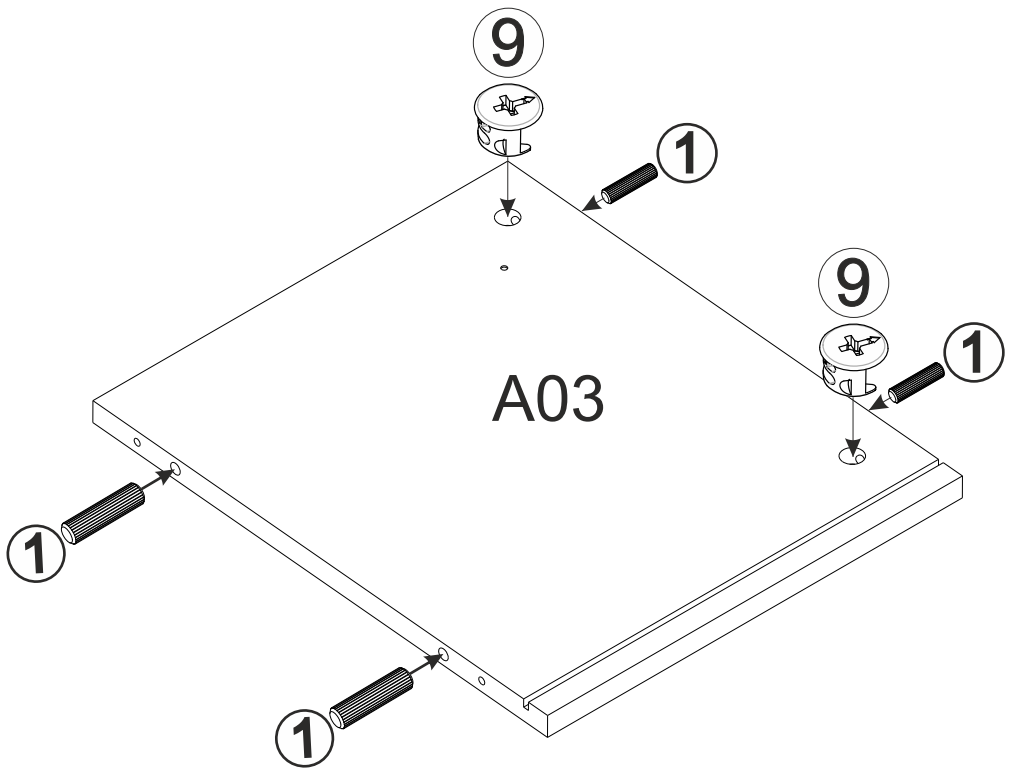
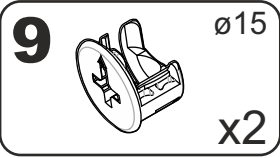
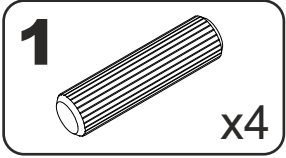

# 6

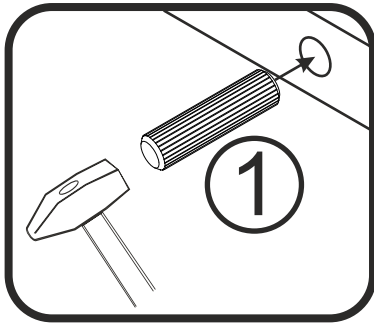
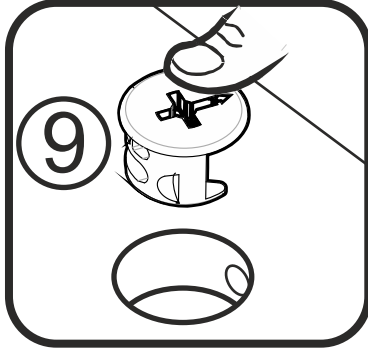
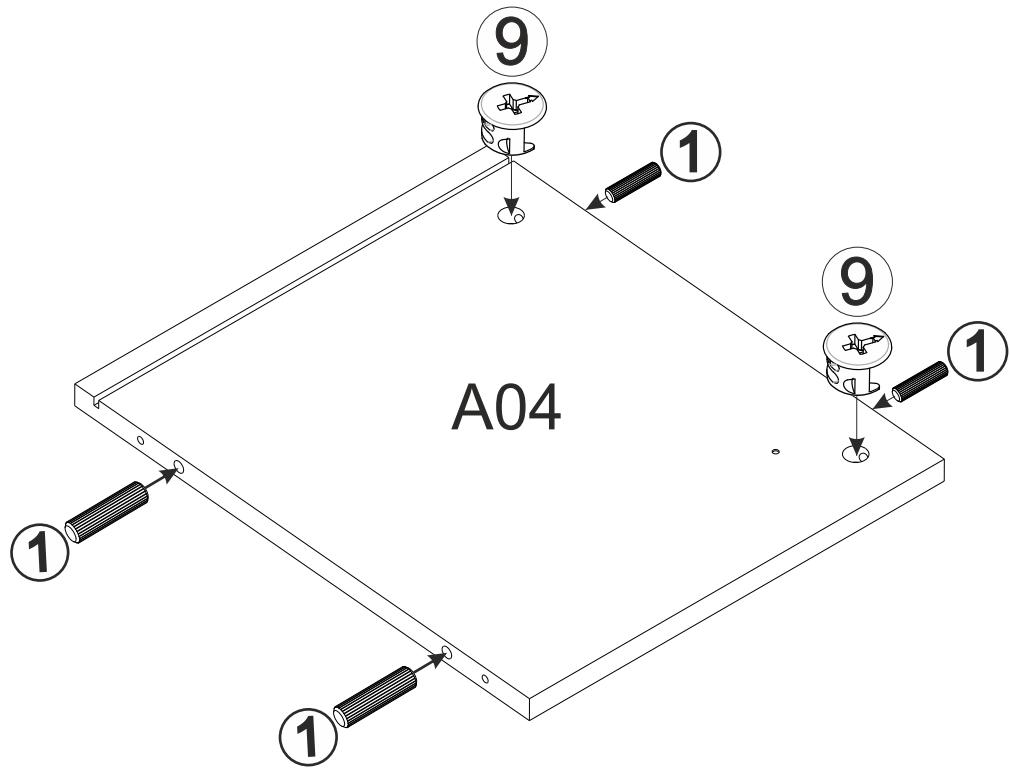
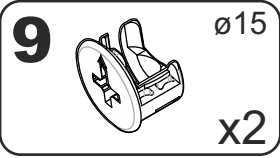
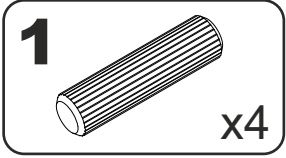



**9A**  x6

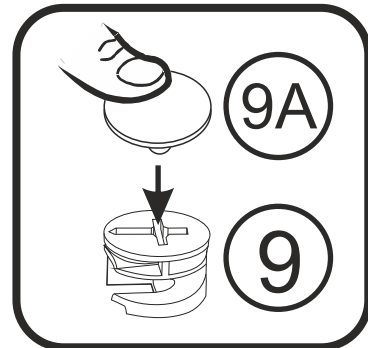
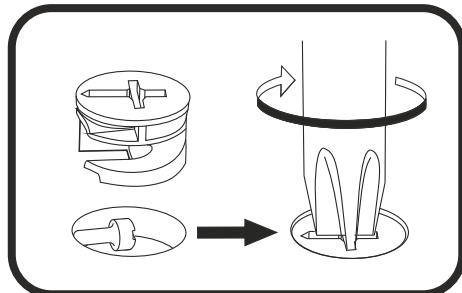
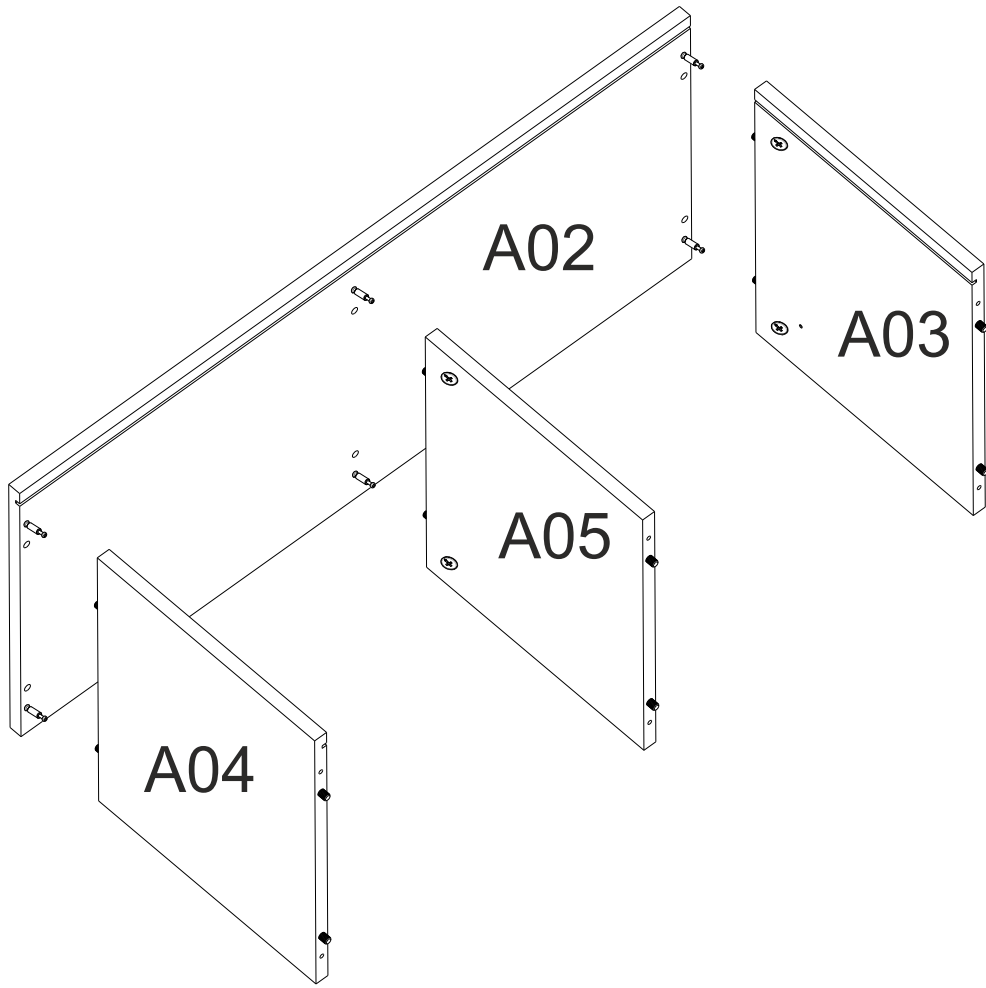

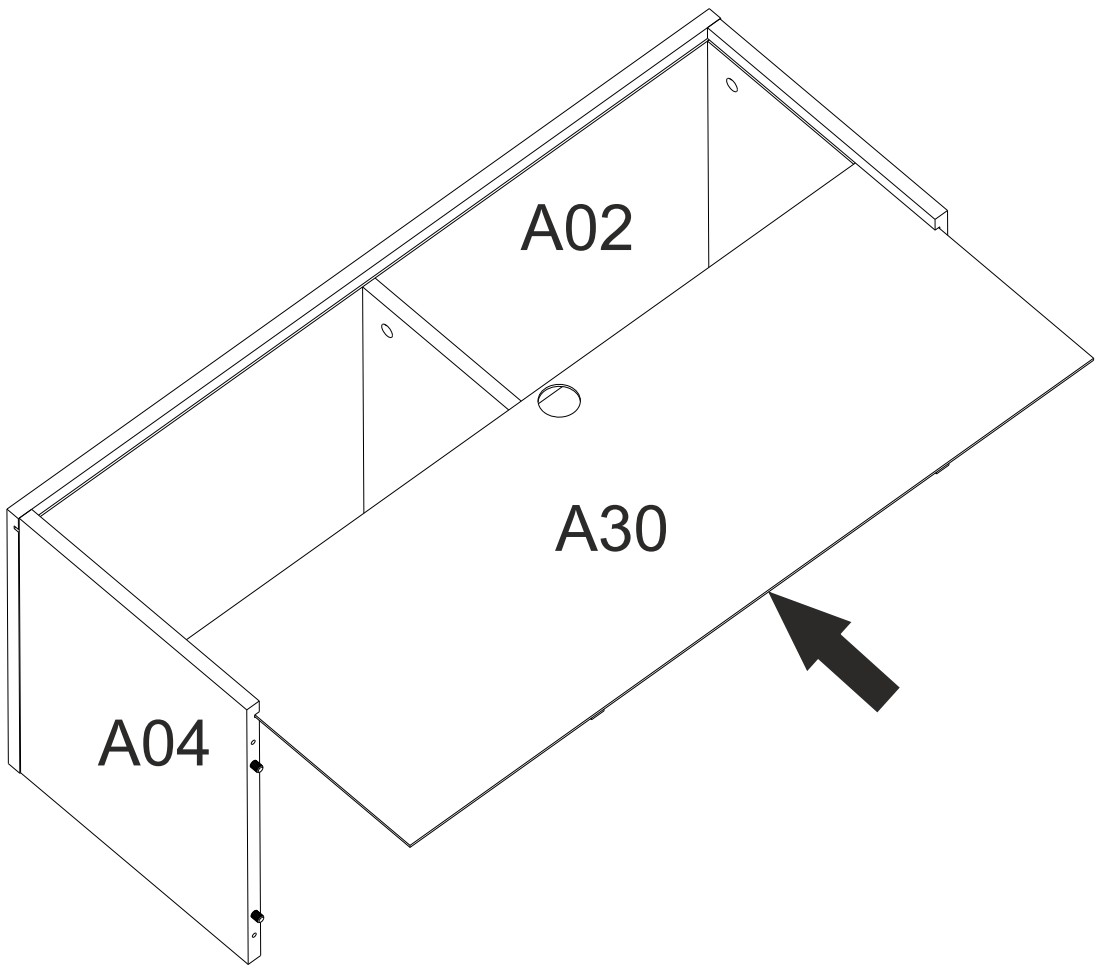

**8**

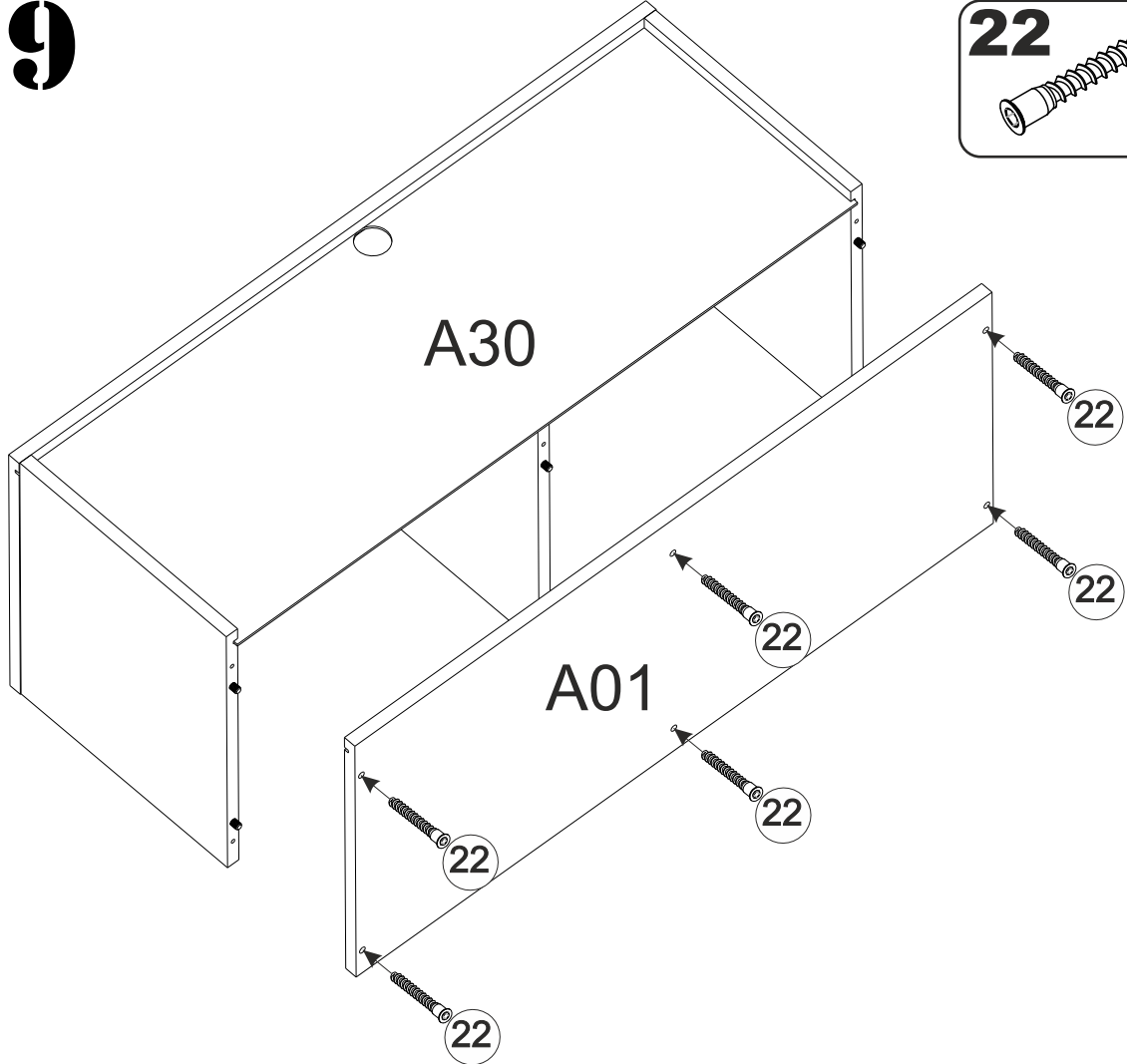

# 9

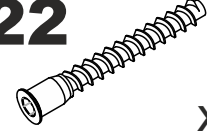

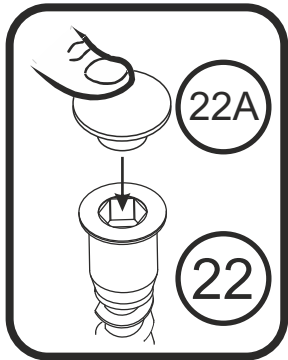
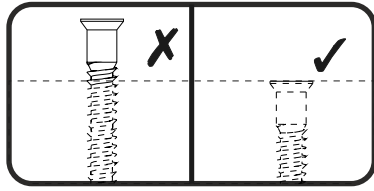
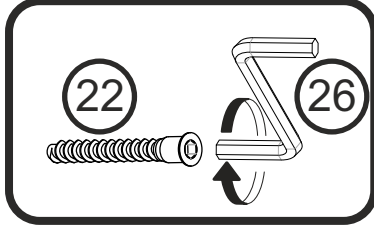

**22**  x6

**22A**  x6



# 10

**4A** <sup>4x16</sup>  x5

**10**  x5

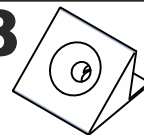
**38**  x8

**39** <sup>3x20</sup>  x10

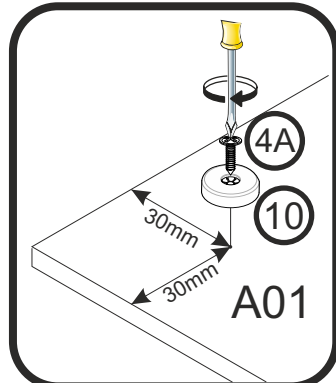
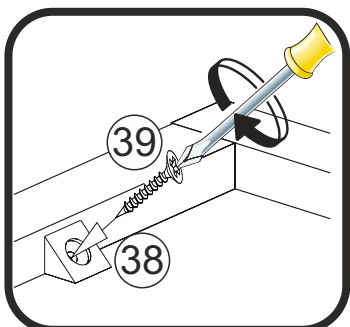
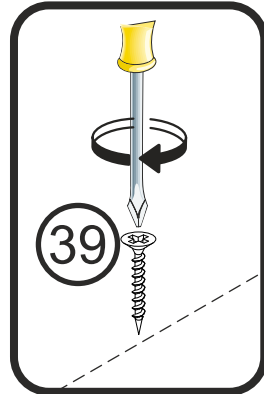
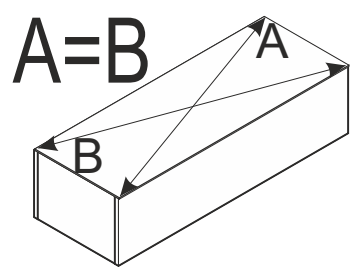
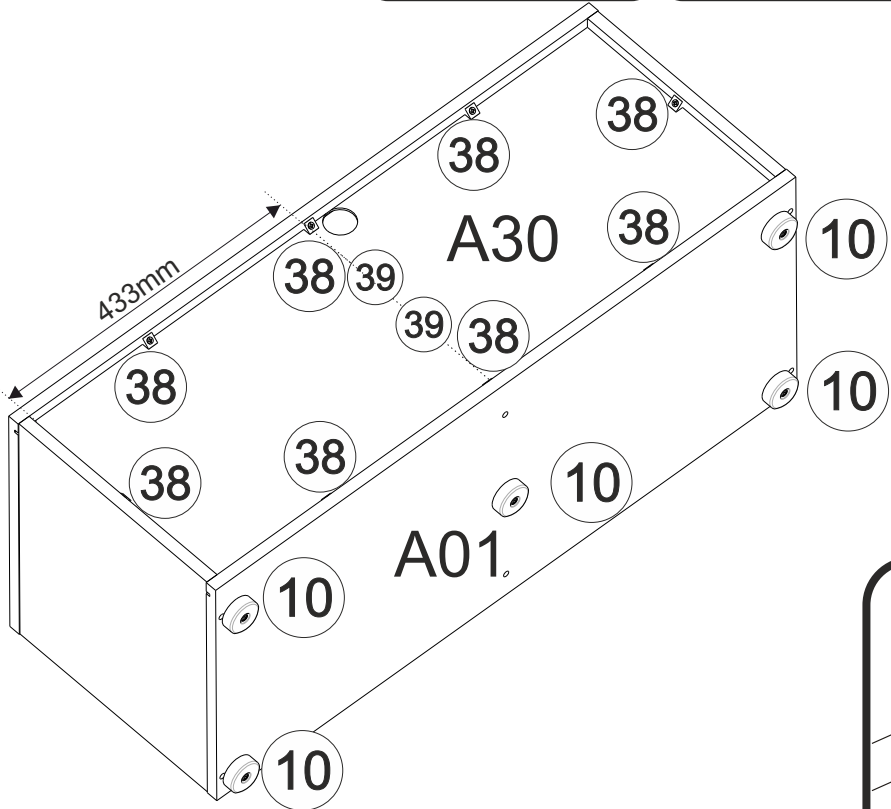

# 11

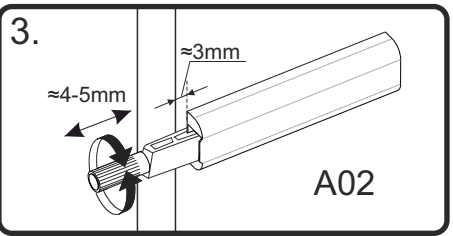
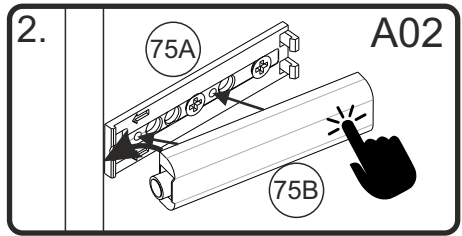
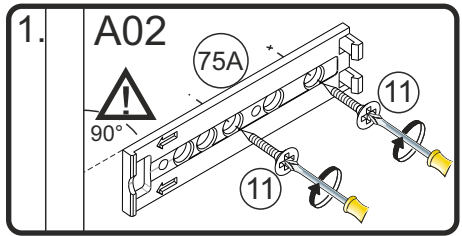
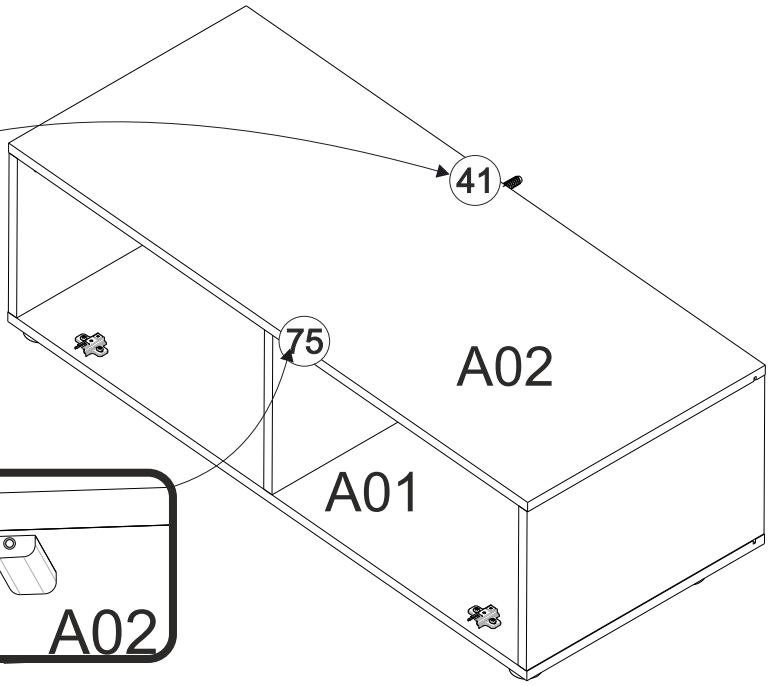
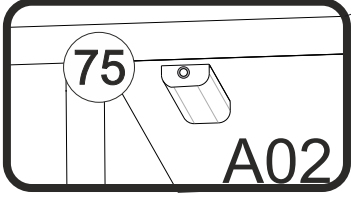
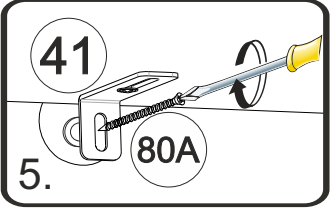
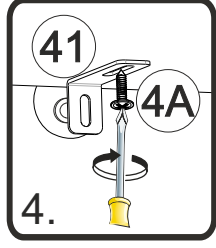
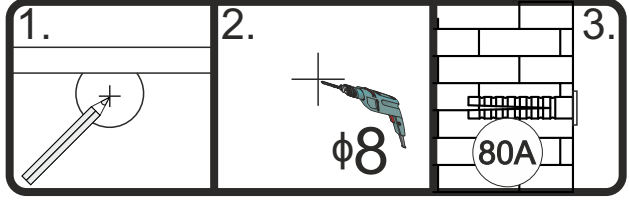
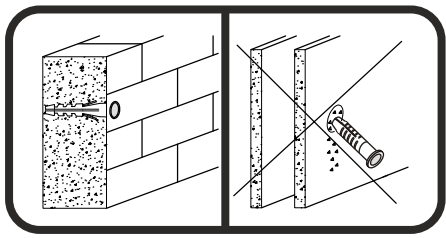
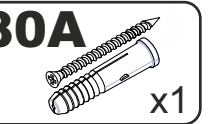
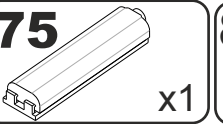
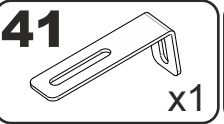
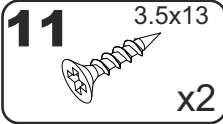
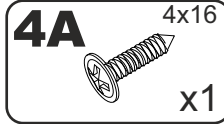

# 12

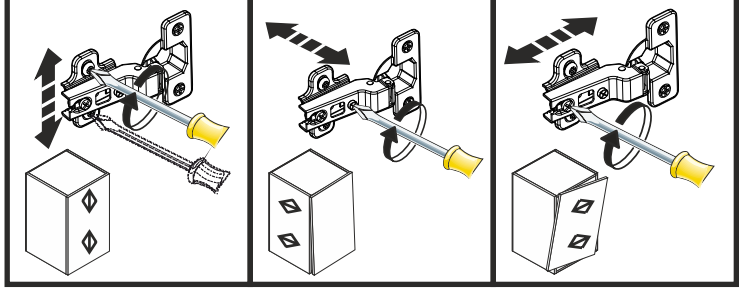
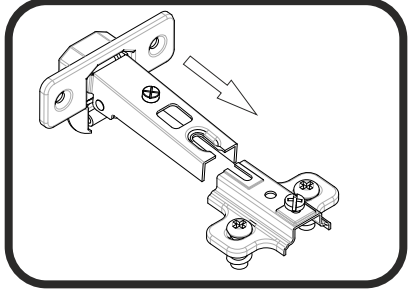
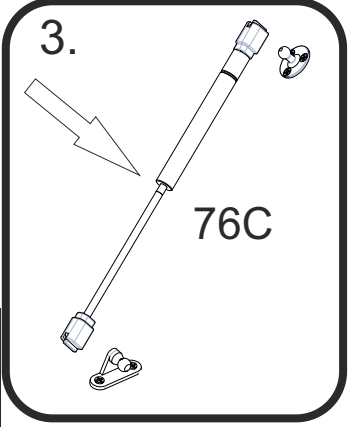
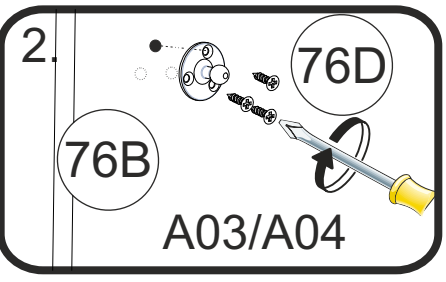
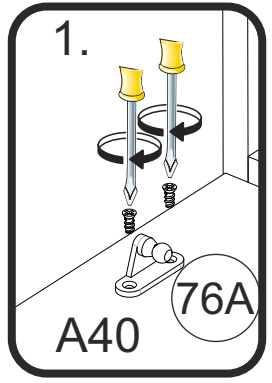
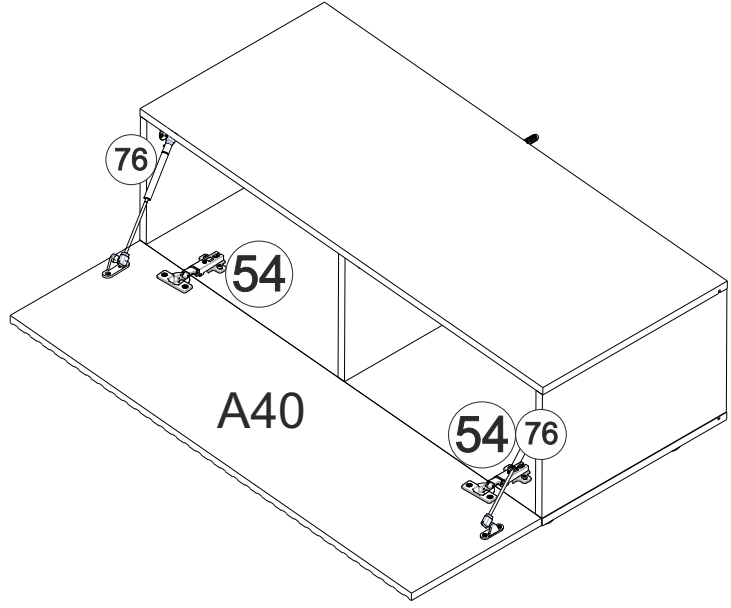
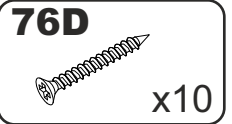
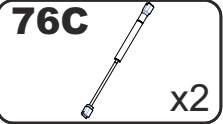
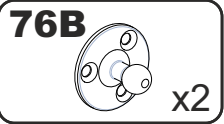
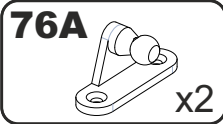

A

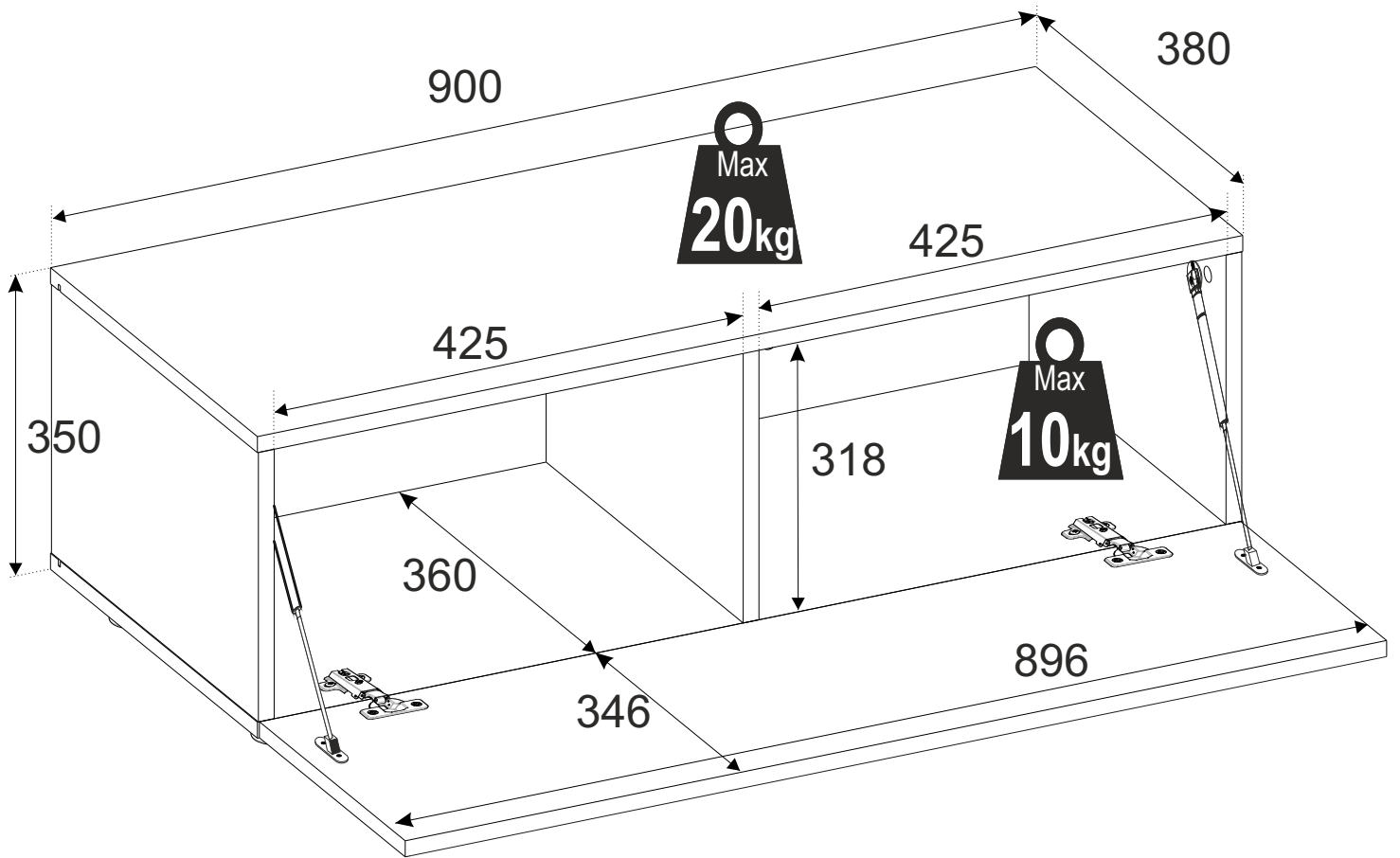
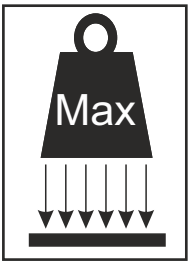

# B

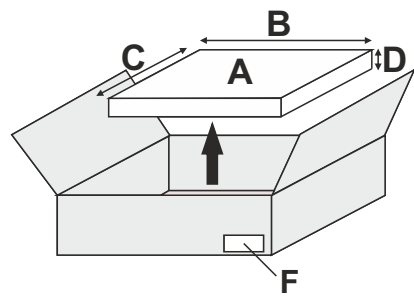
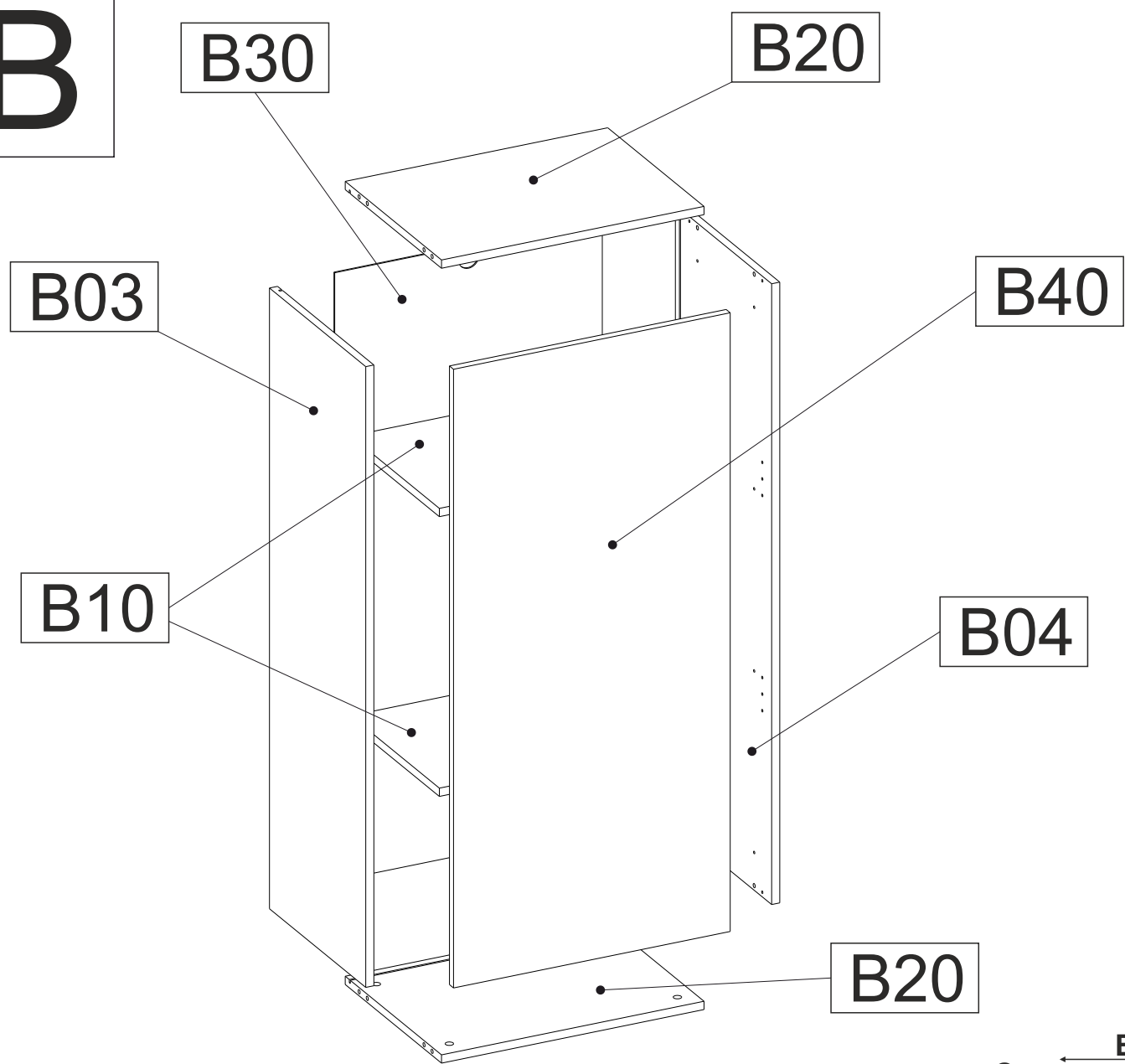

A	B_(mm)	C_(mm)	D_(mm)	E	F
B03	1200	380	16	1	1 3
B04	1200	380	16	1	1 3
B10	518	350	16	2	1 3
B20	518	380	16	2	1 3
B30	1176	528	3	1	1 3
B40	1196	546	16	1	1 3

# 1

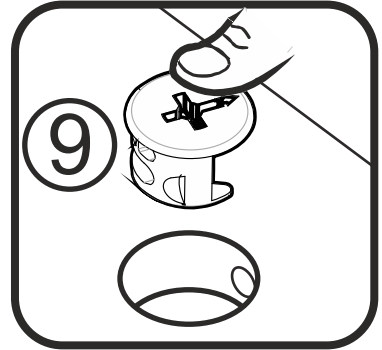
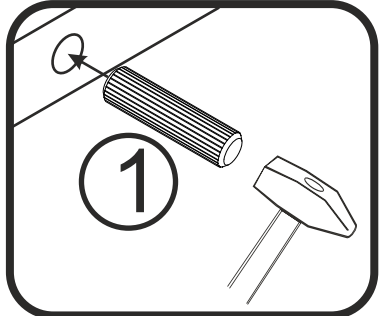
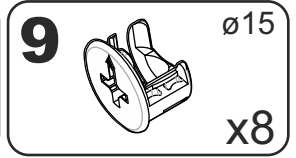
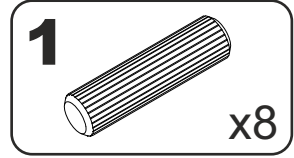
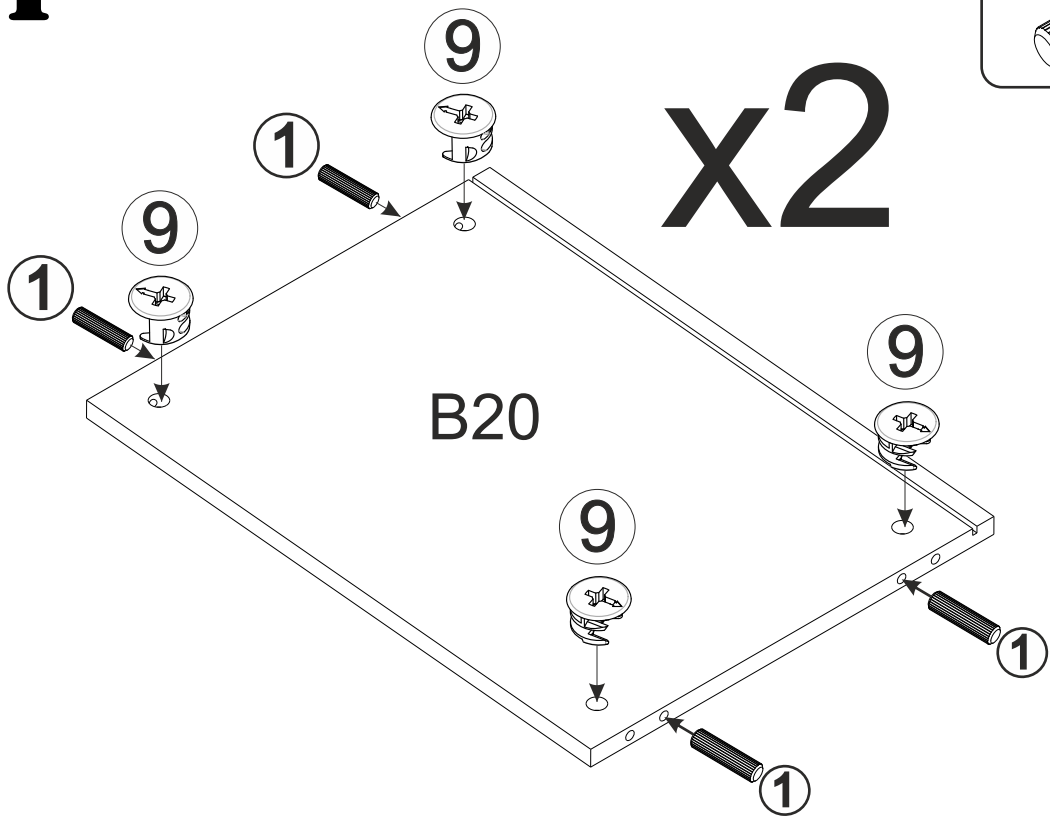

# 2

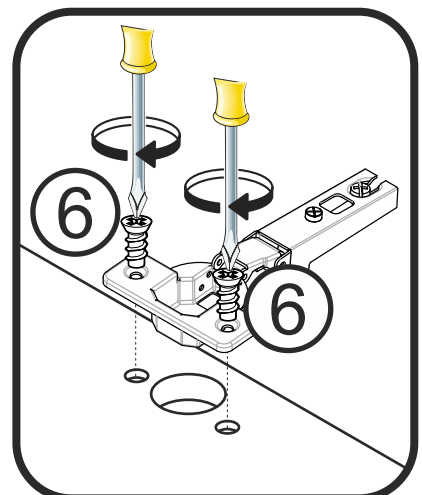
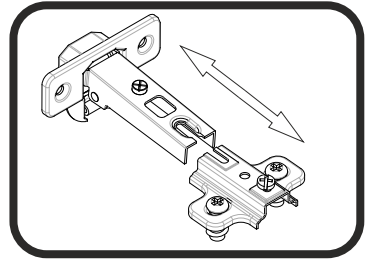
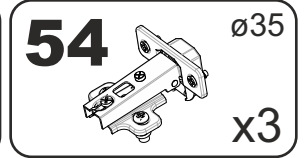
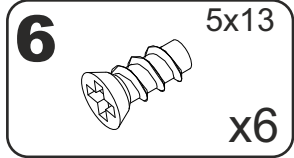
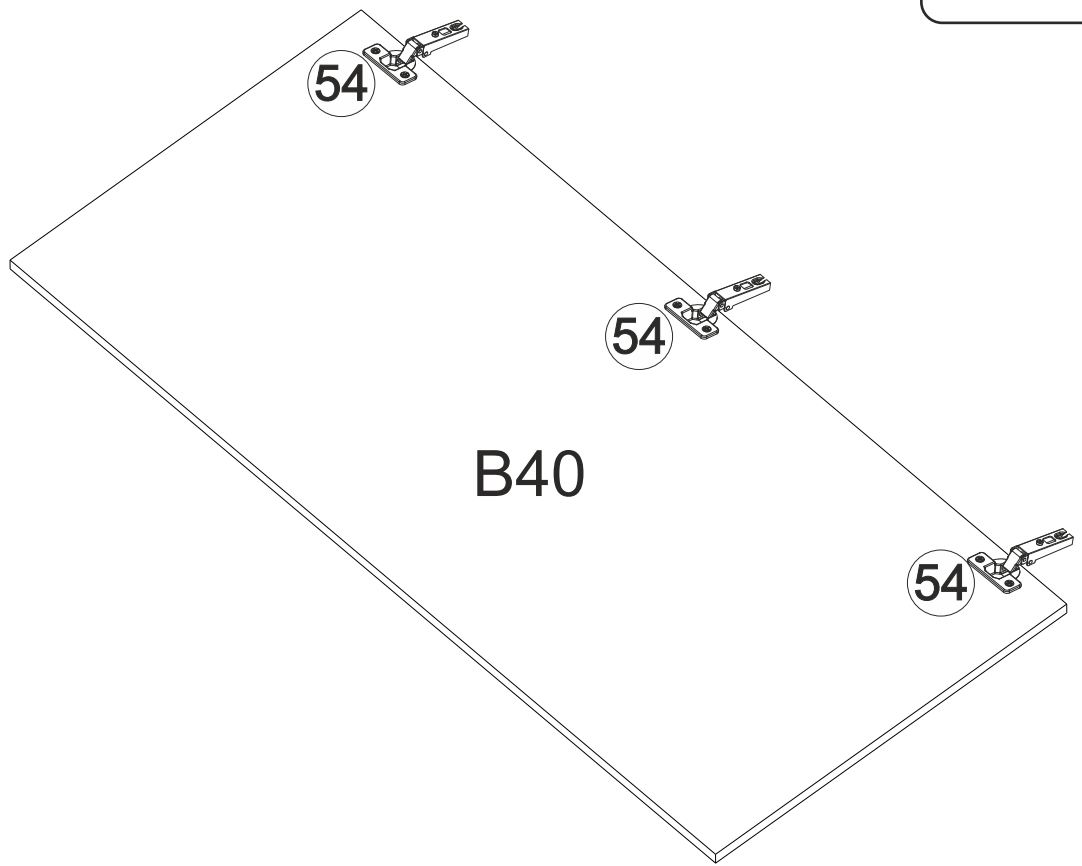

# 3

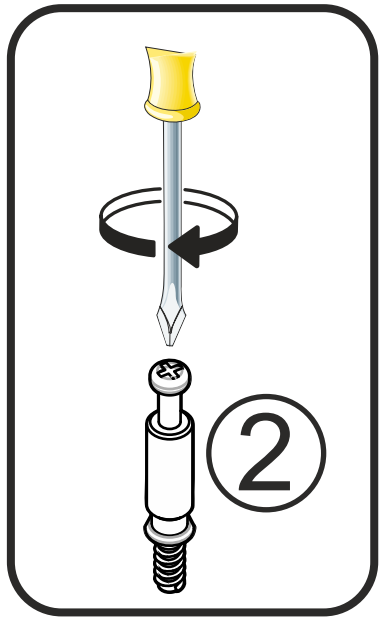
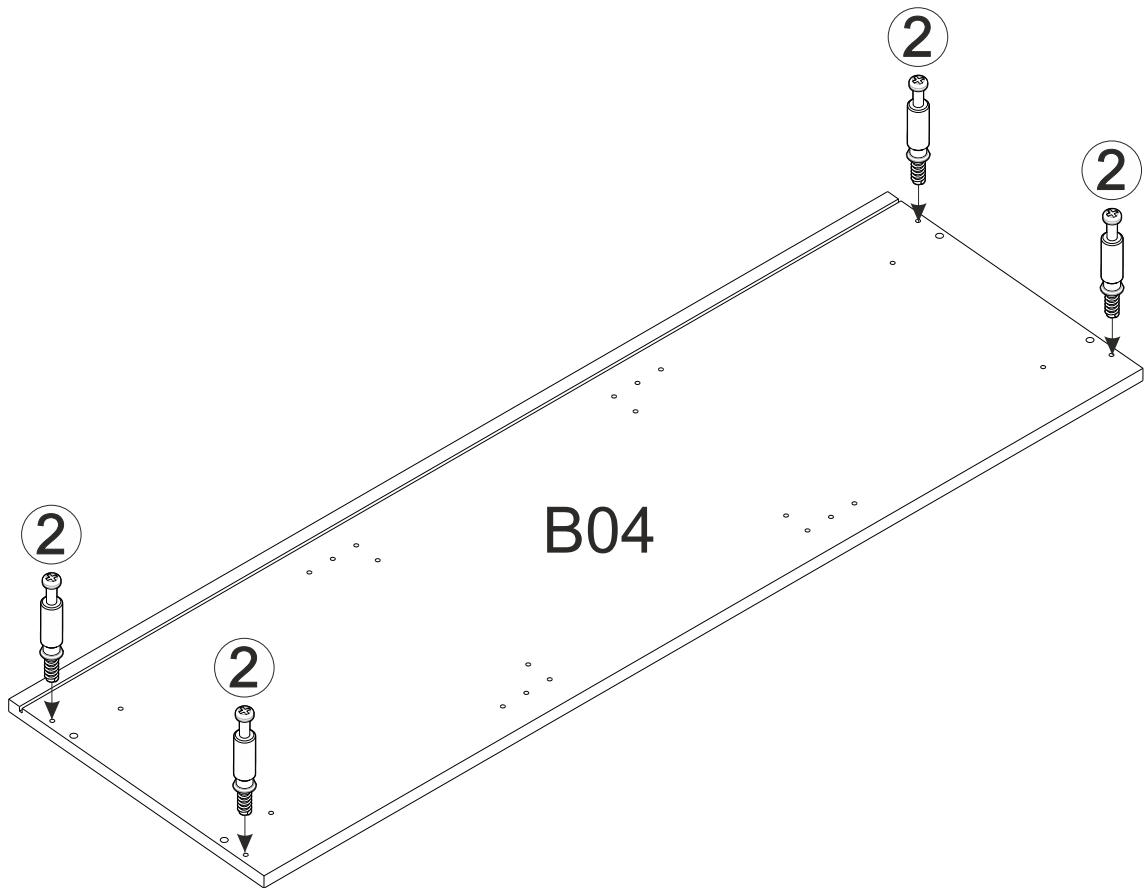
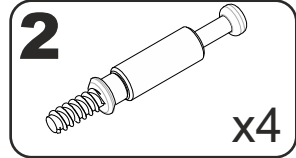

# 4

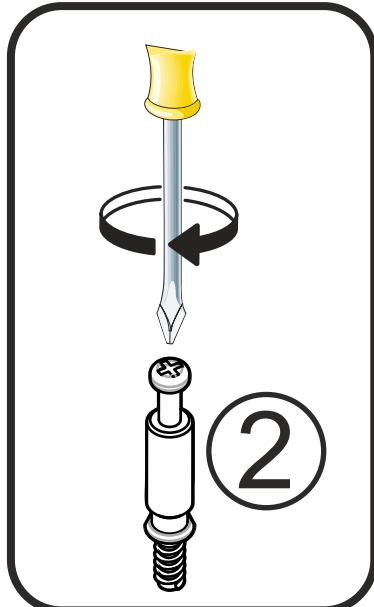
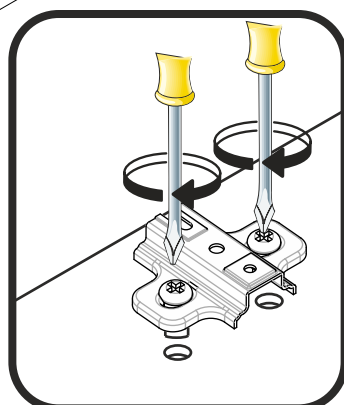
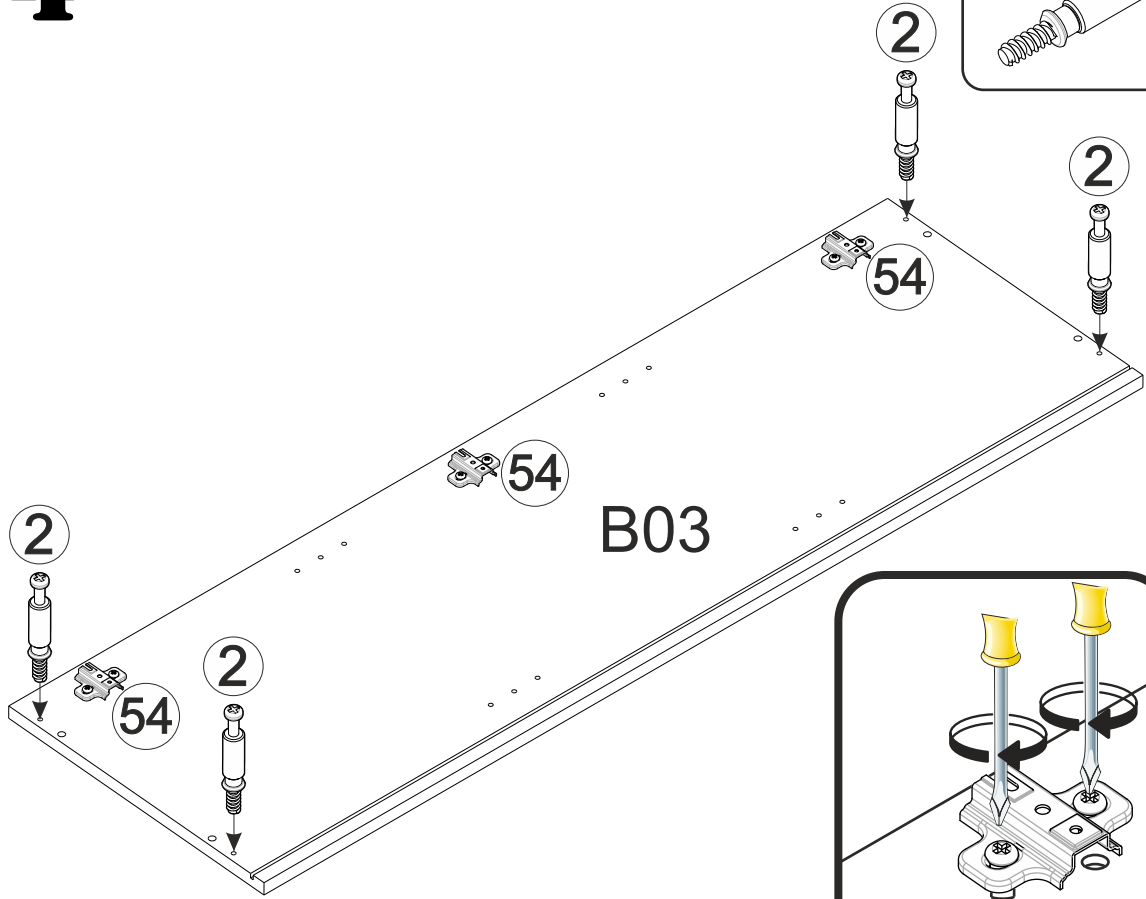
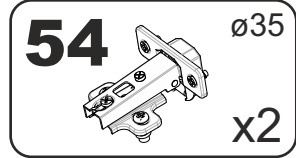
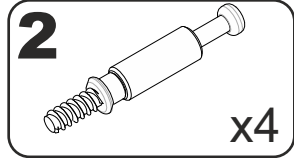

# 5

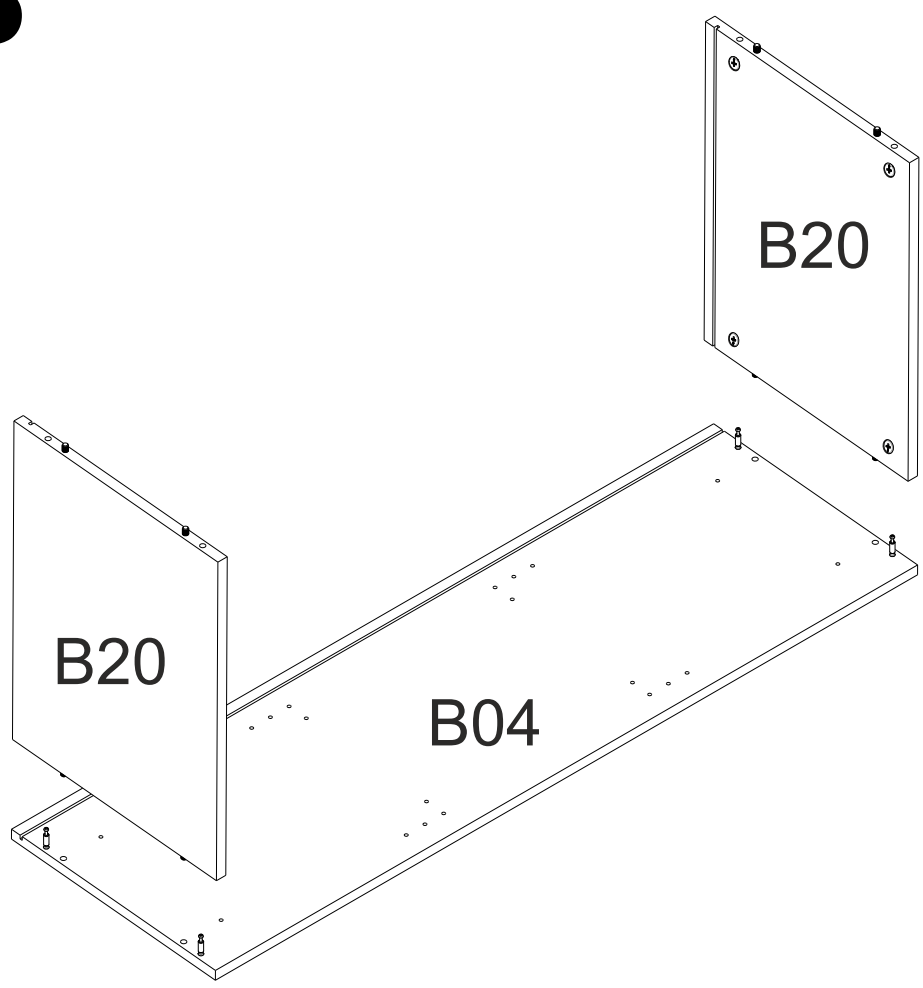

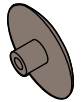
**9B**  x4

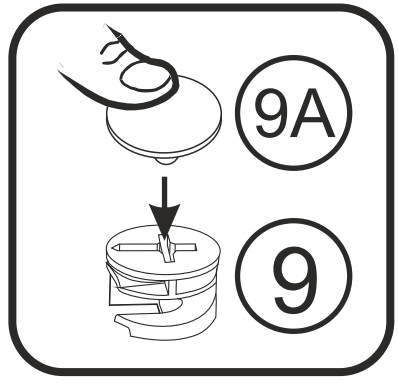
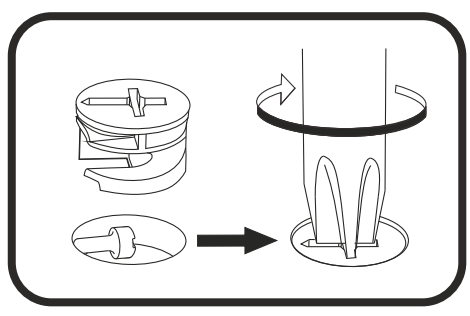

# 6

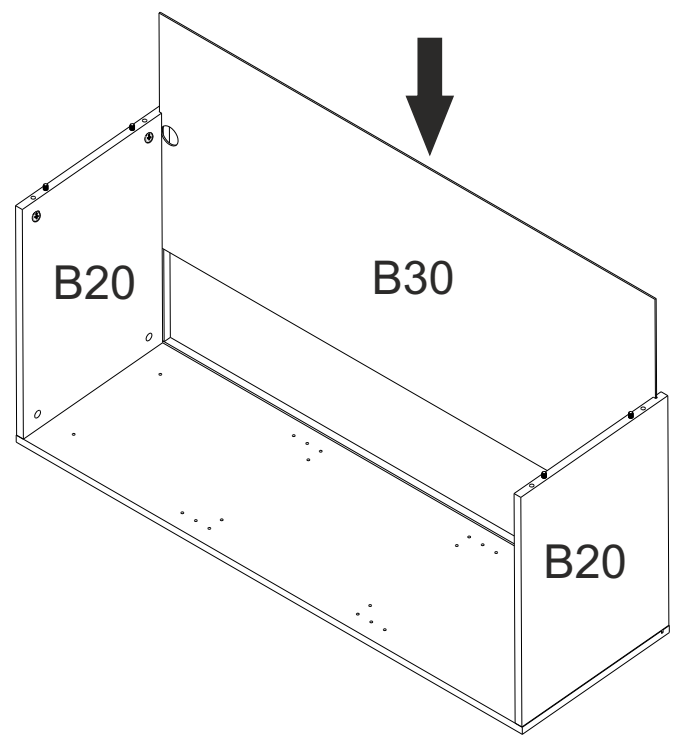
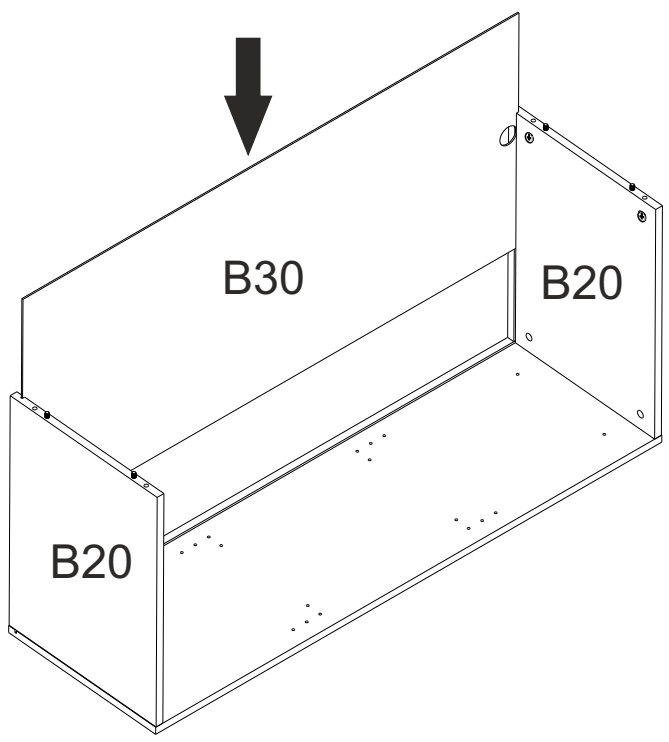

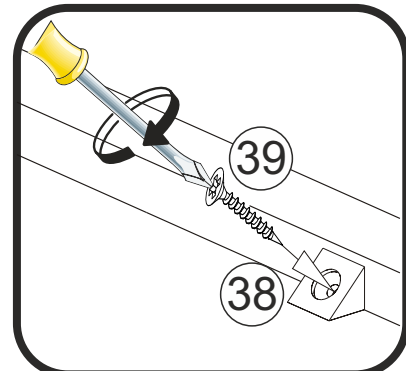
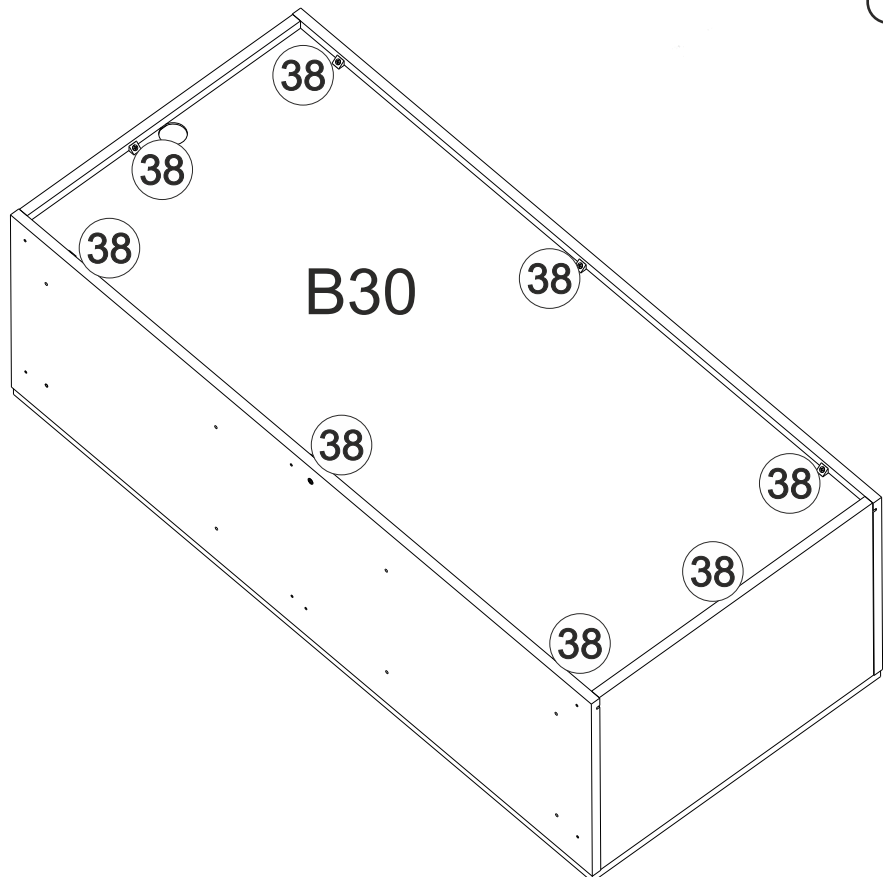
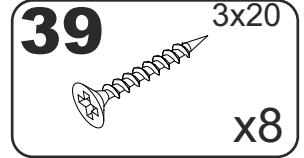
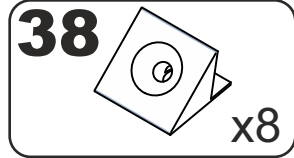
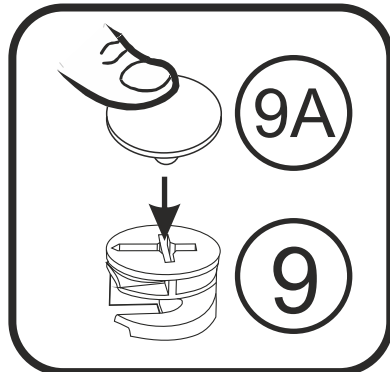
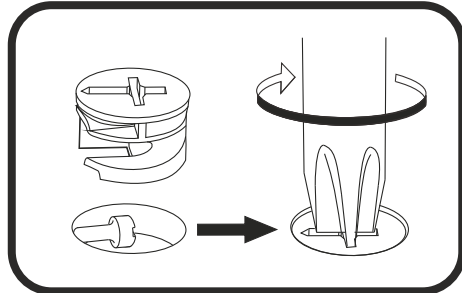
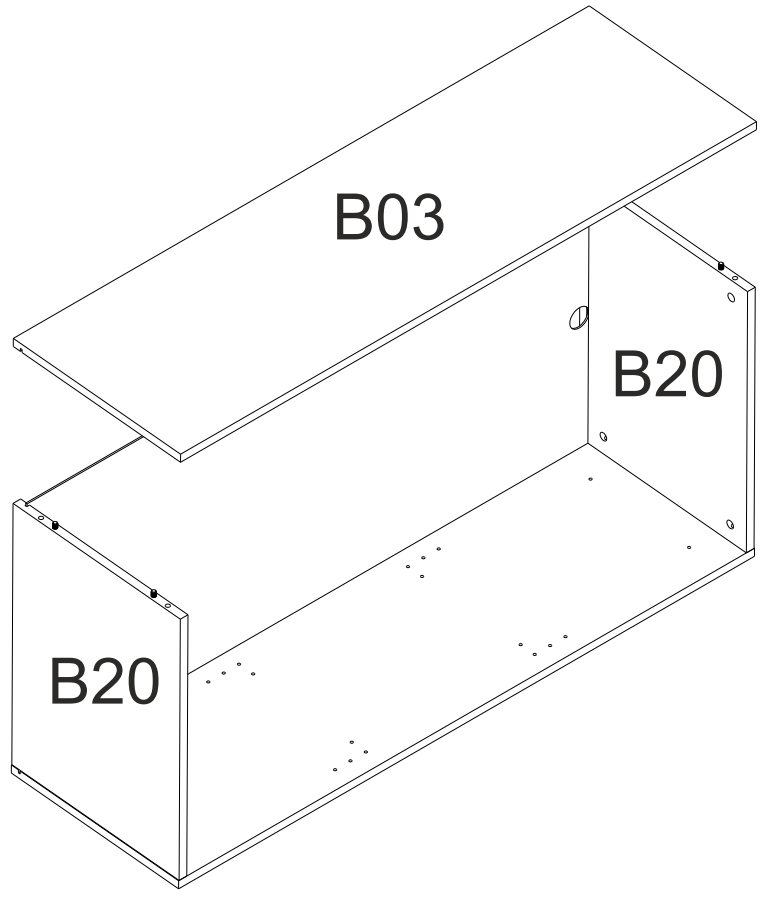
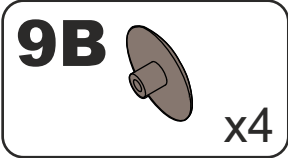

# 9

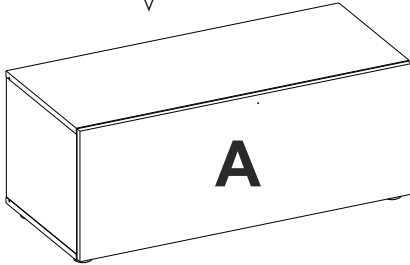
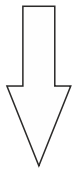
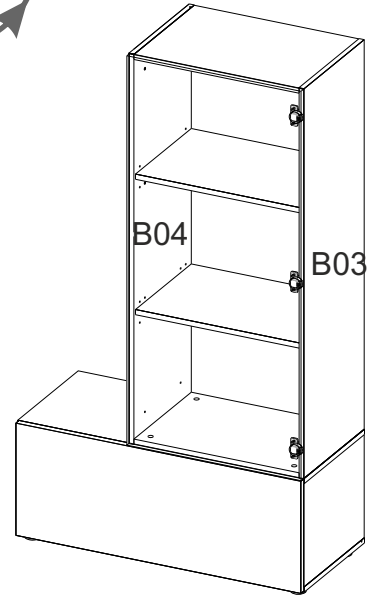
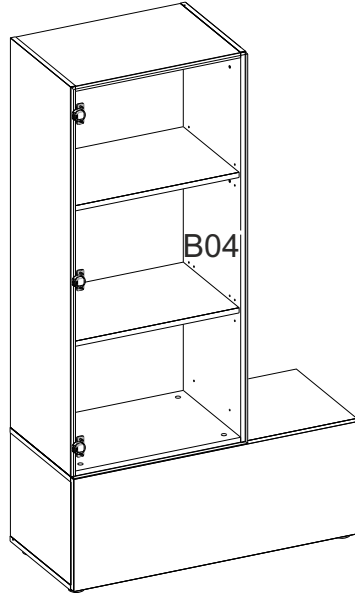
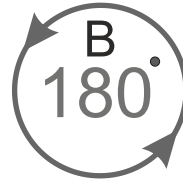
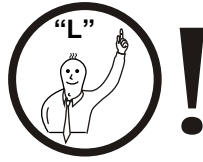
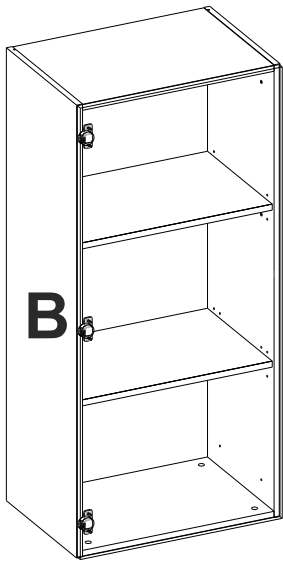

# 10

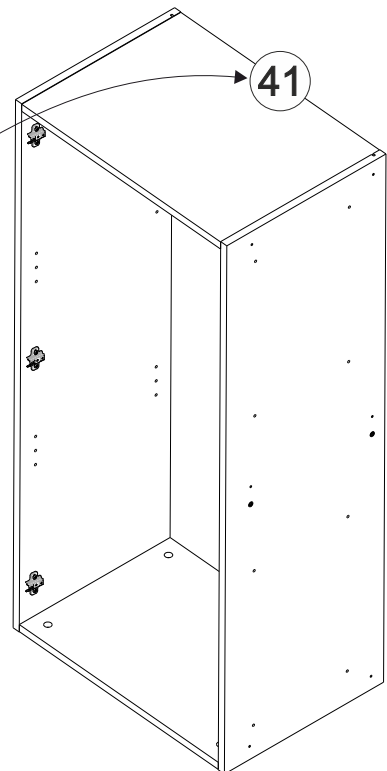
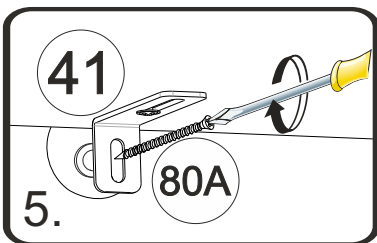
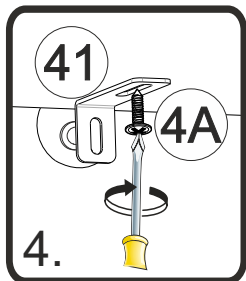
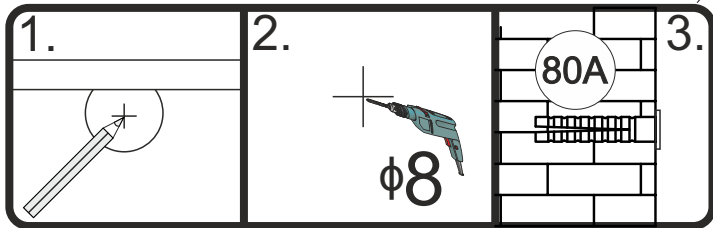
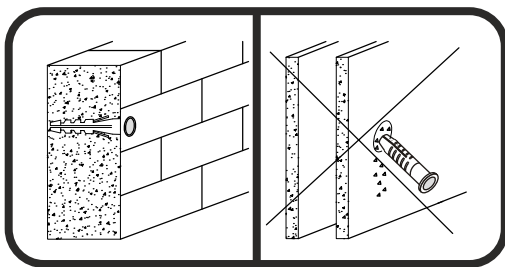
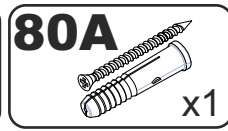
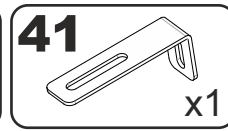
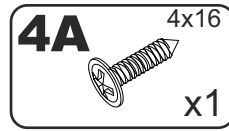

# 11

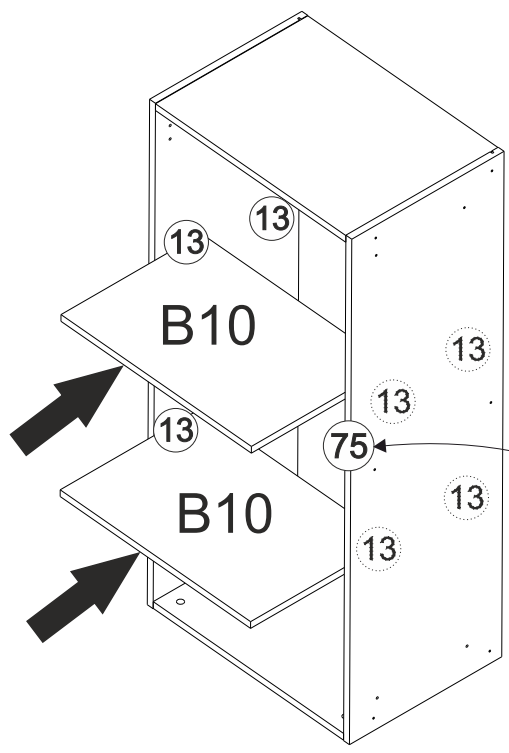

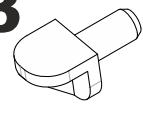
**13**  x8

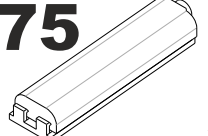
**75**  x1

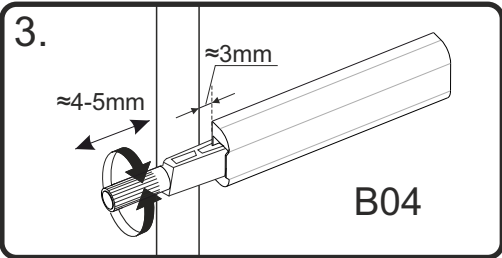
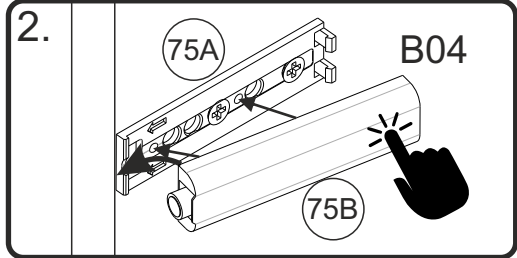
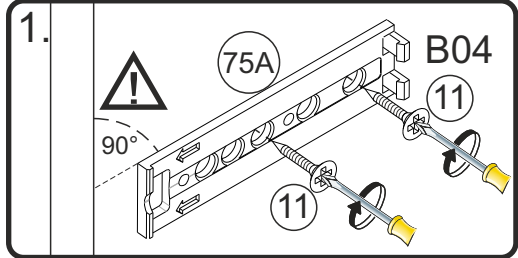
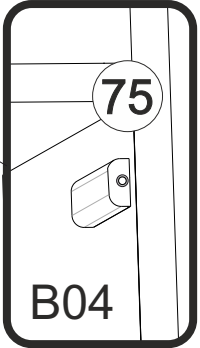
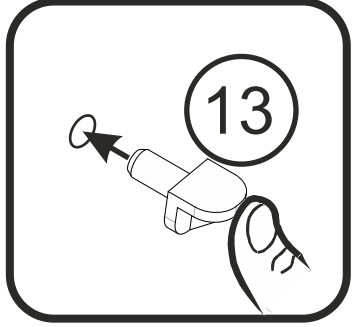

# 12

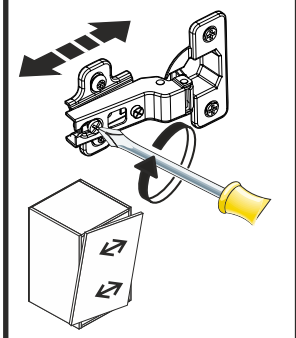
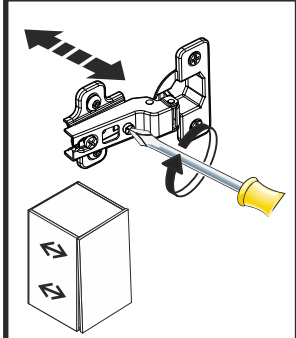
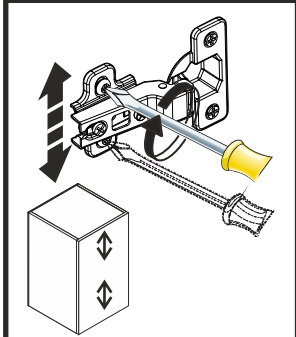
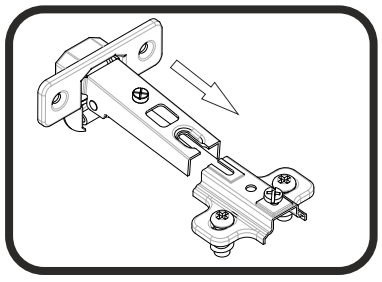
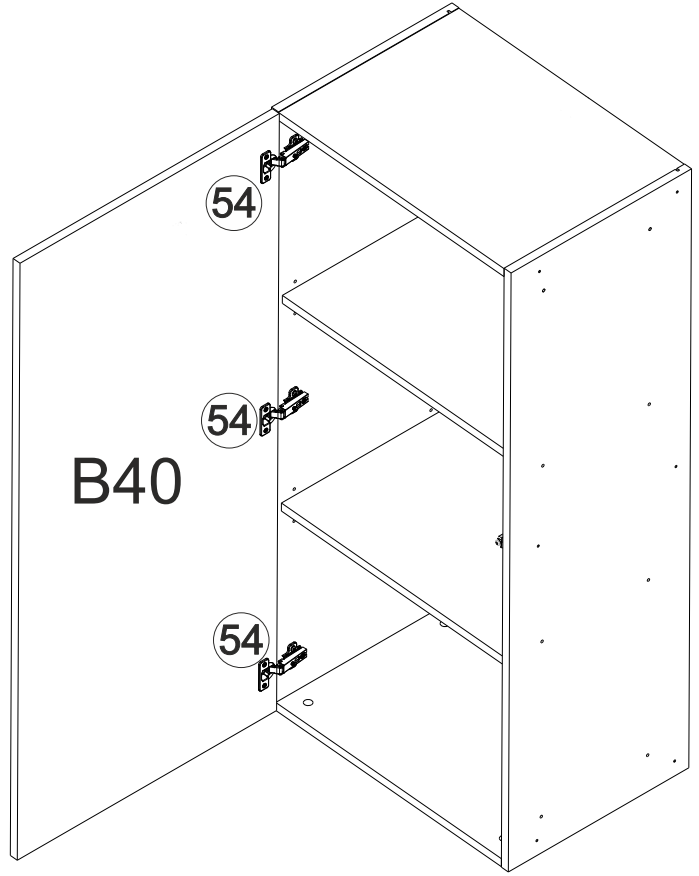

**B**

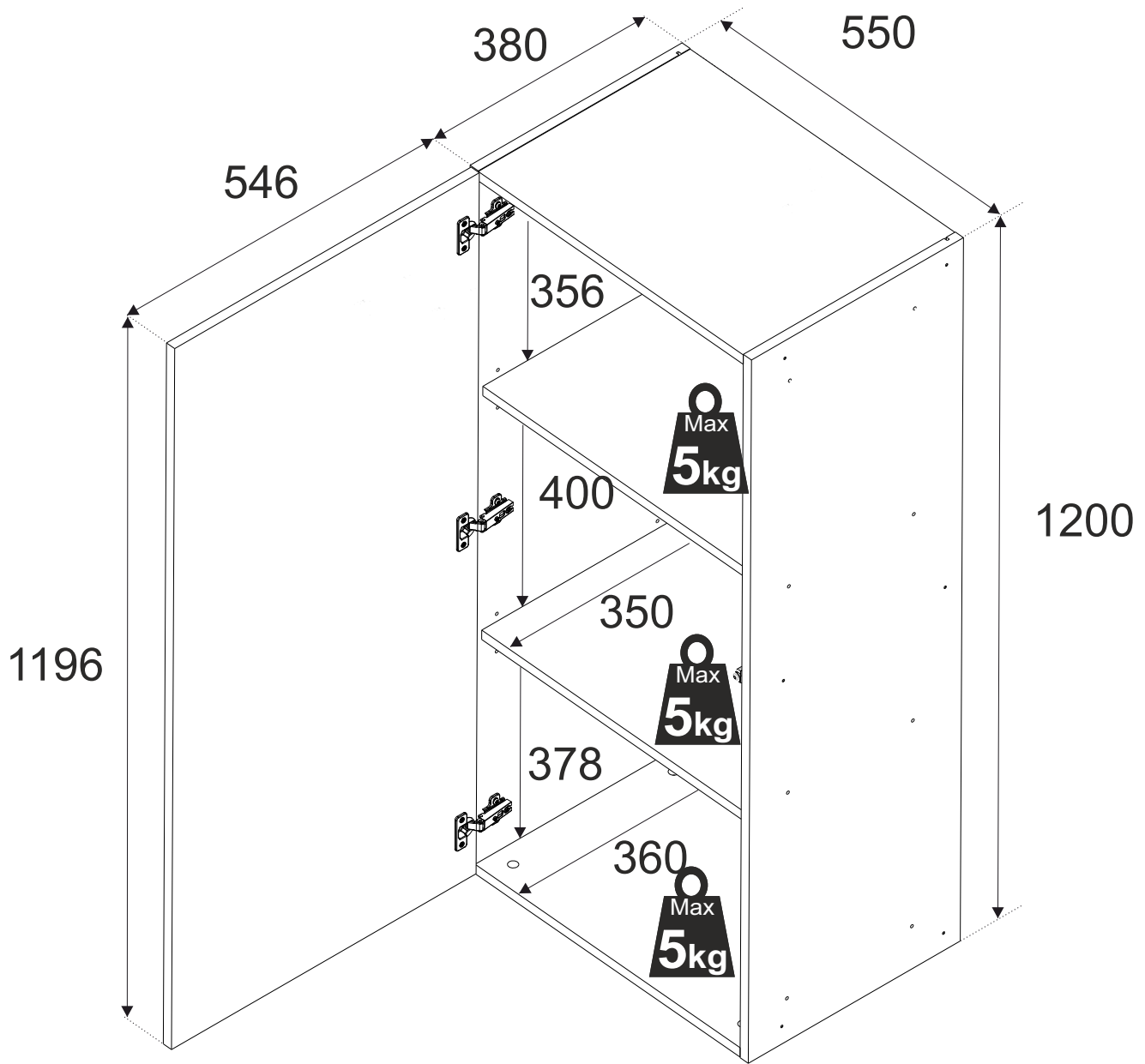

# C

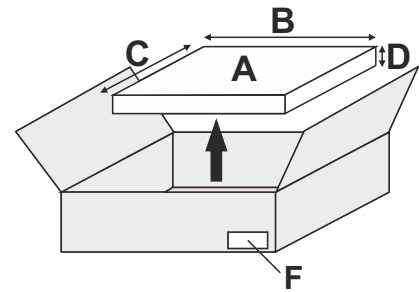
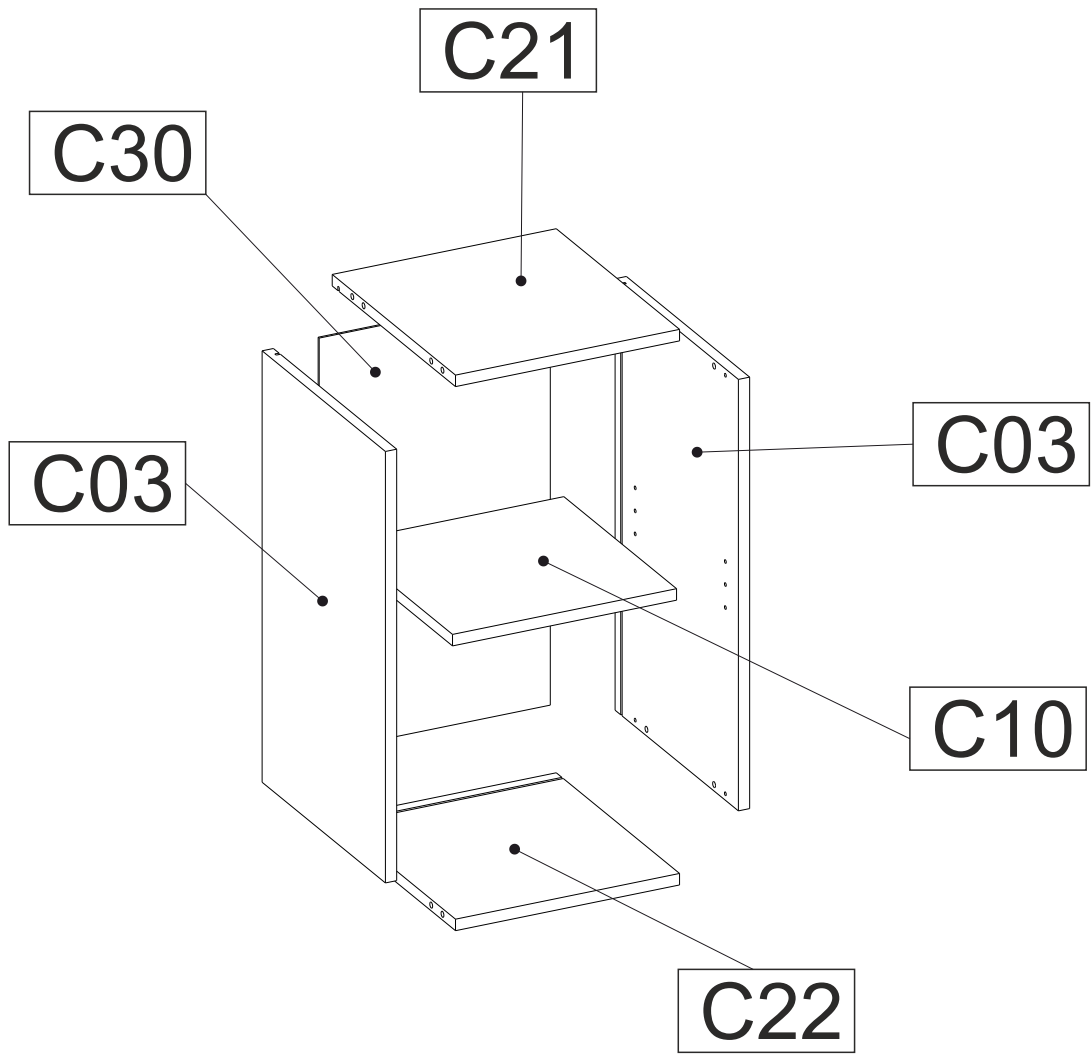

A	B_(mm)	C_(mm)	D_(mm)	E	F
C03	600	350	16	2	3 3
C10	318	320	16	1	3 3
C21	318	350	16	1	3 3
C22	318	350	16	1	3 3
C30	576	328	3	1	3 3

# 1

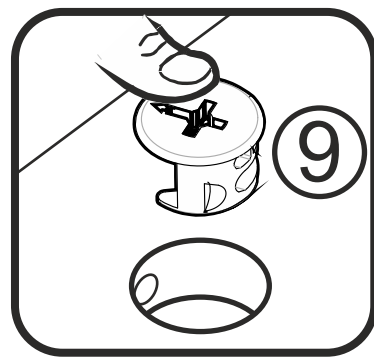
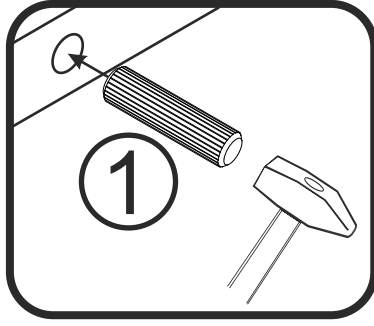
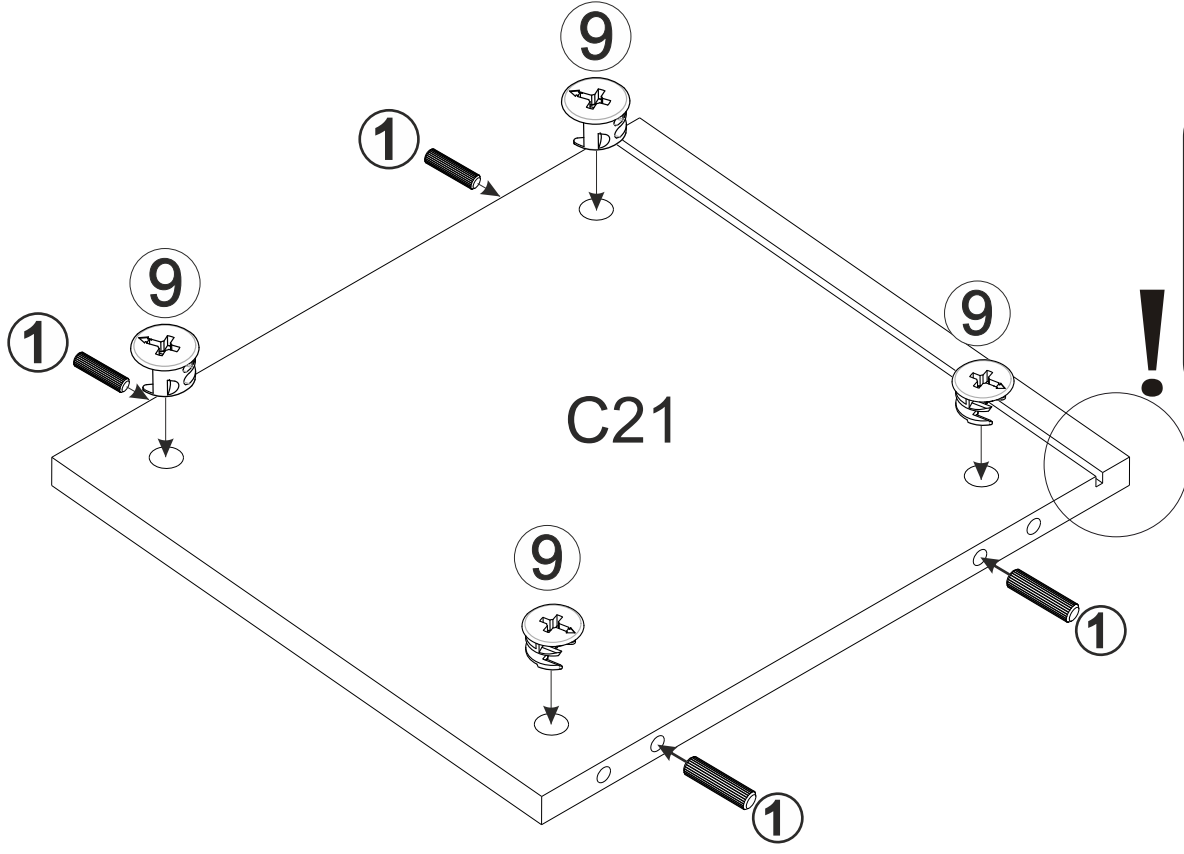
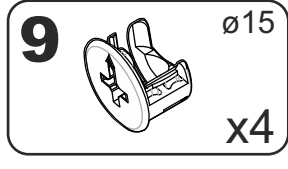
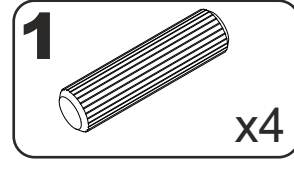

# 2

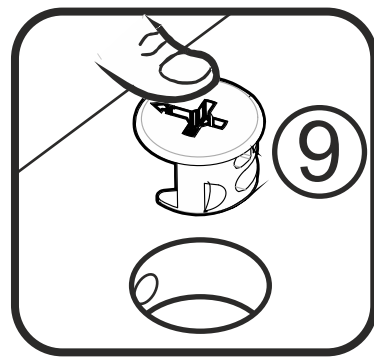
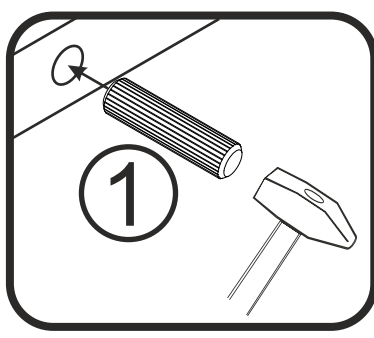
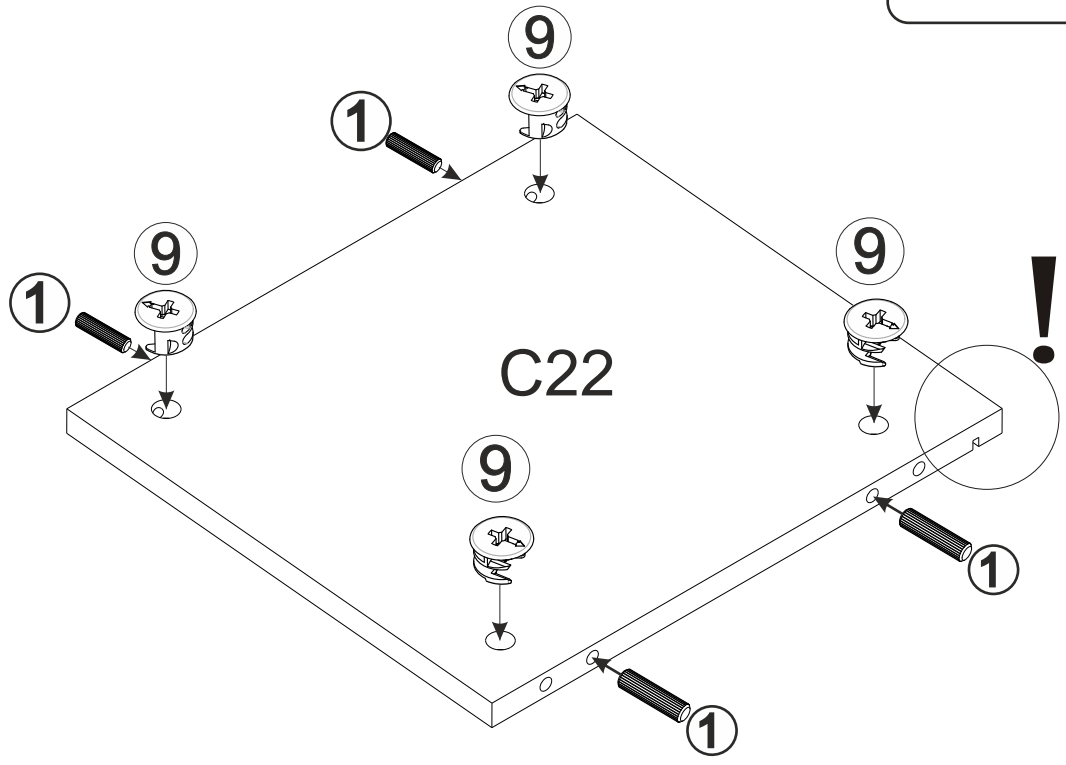
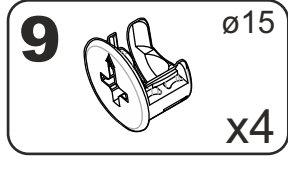
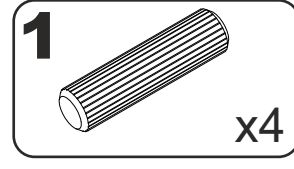

# 3

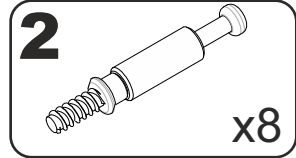
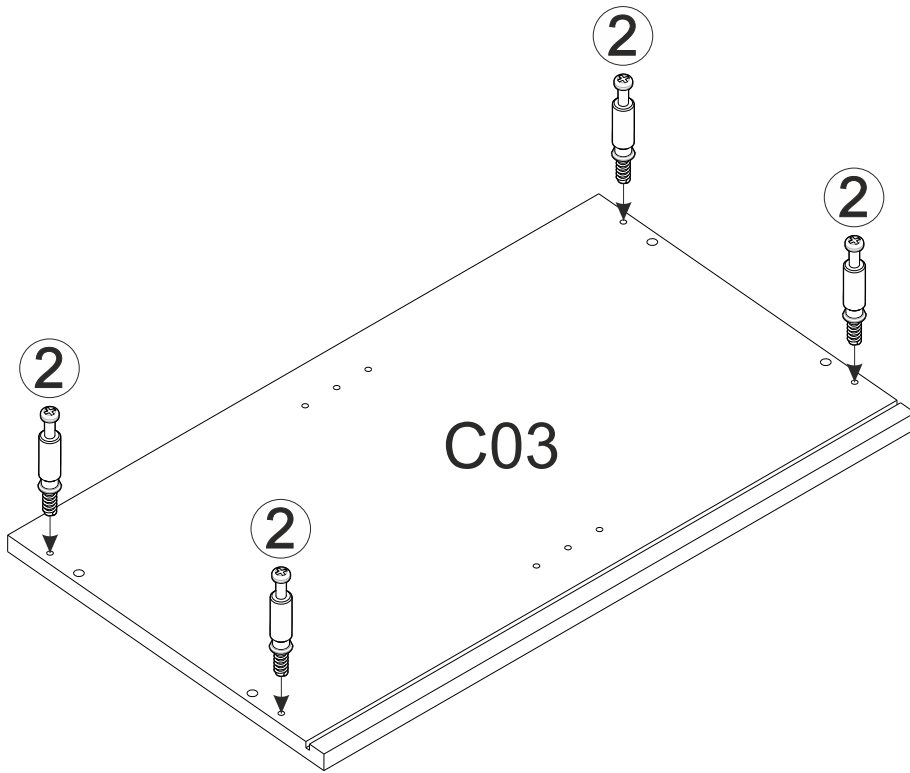

# x2

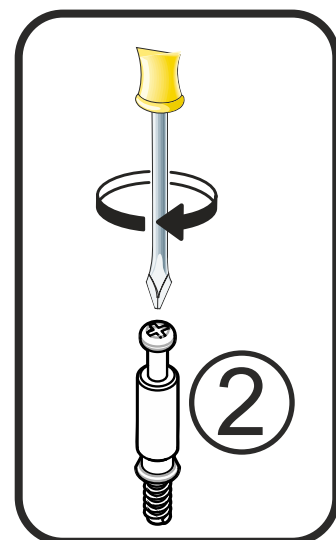

# 4

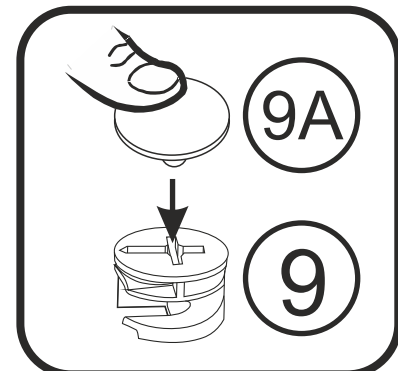
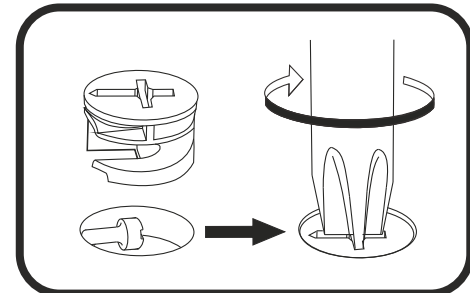
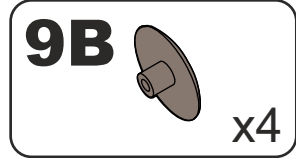
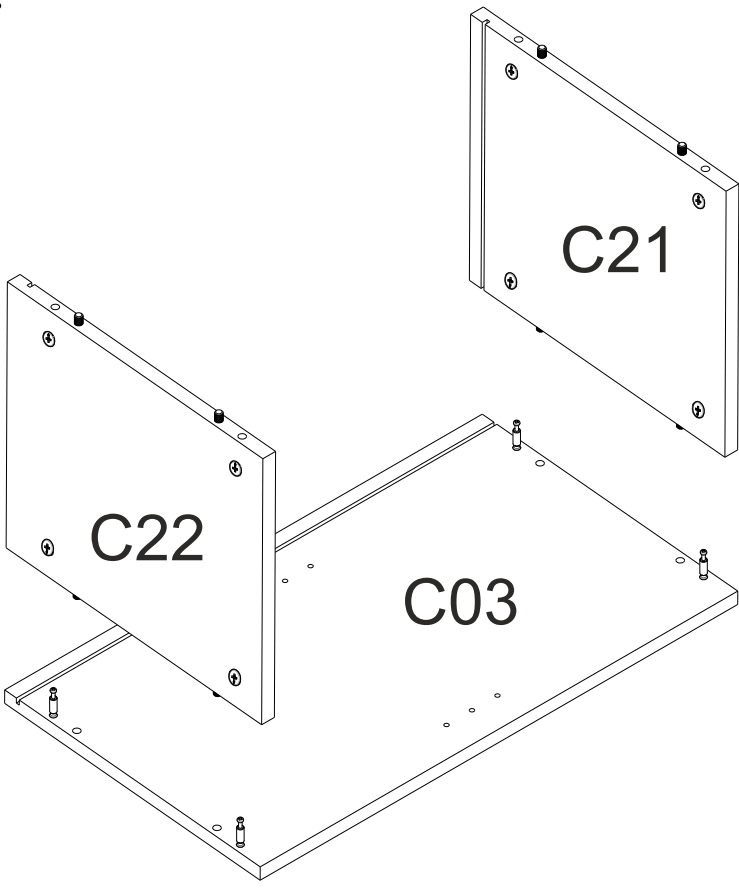

5

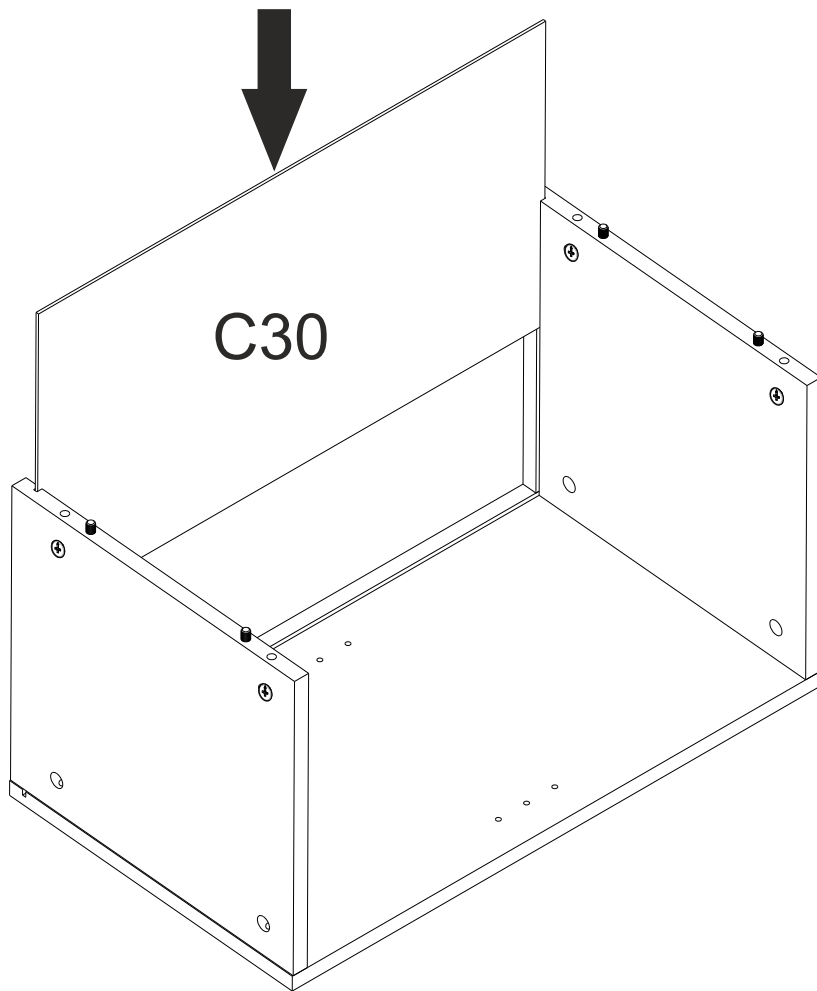

6

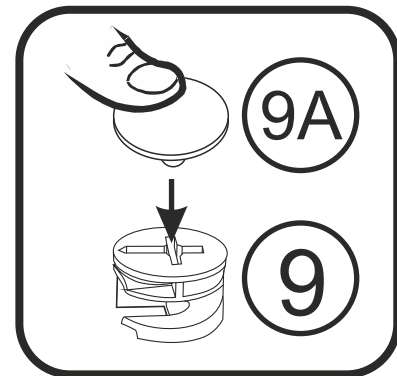
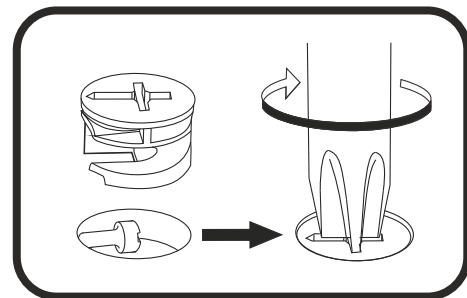
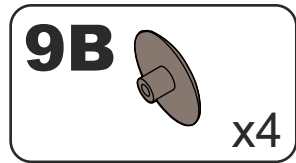
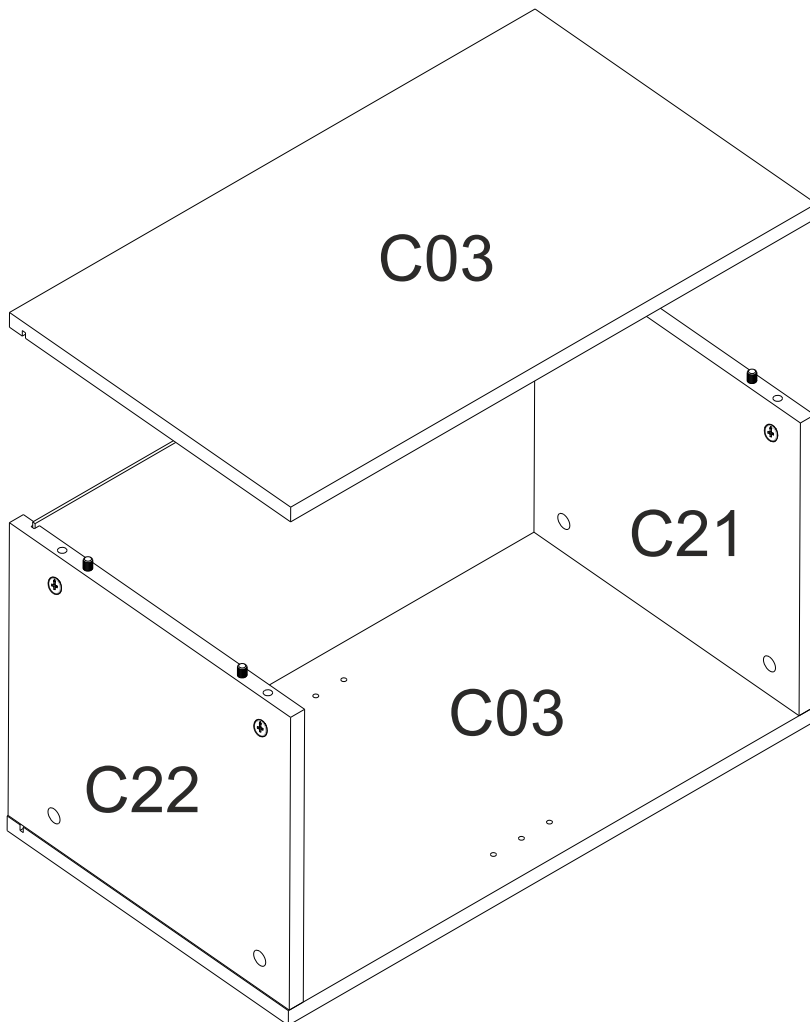

7

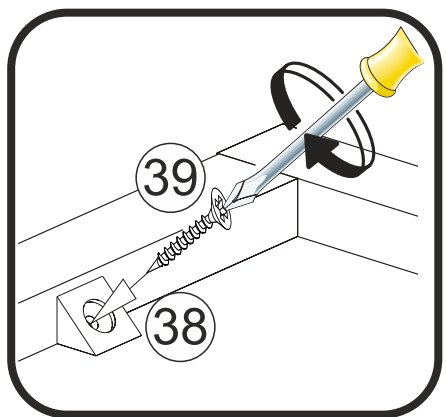
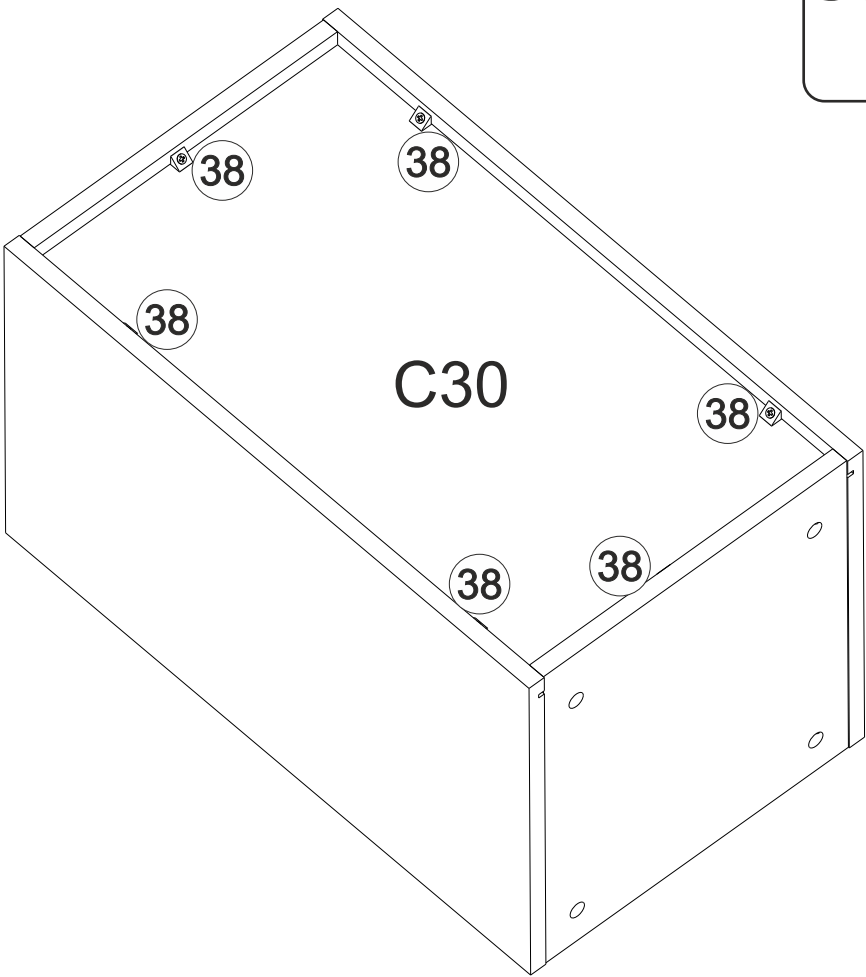
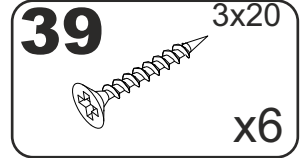
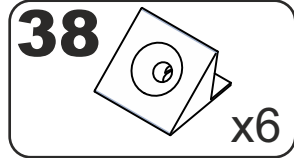

8

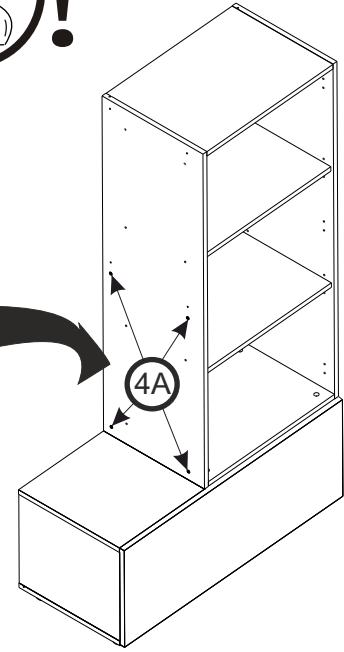
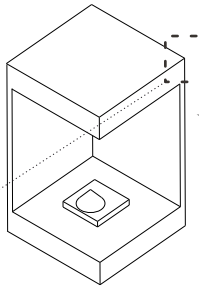
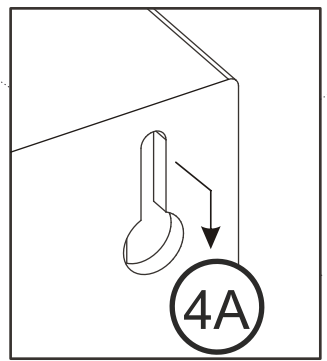
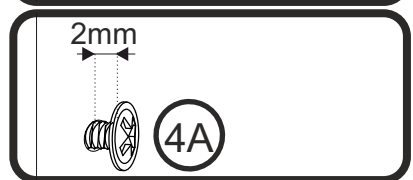
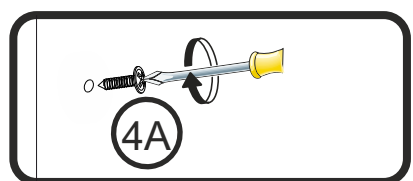
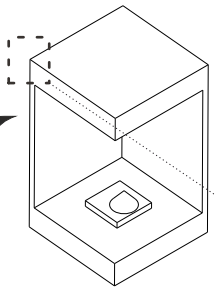
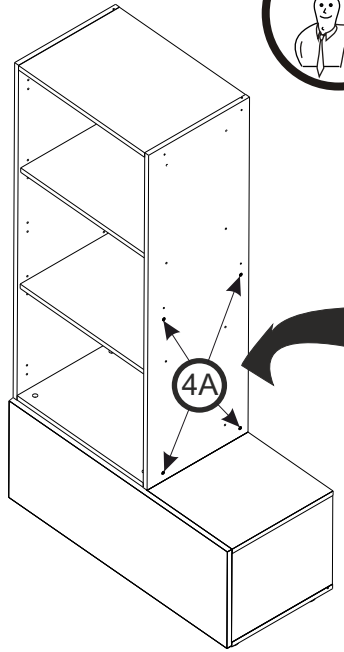
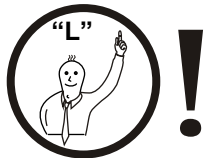
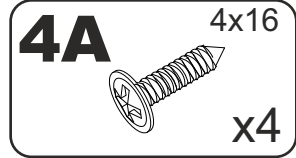

9

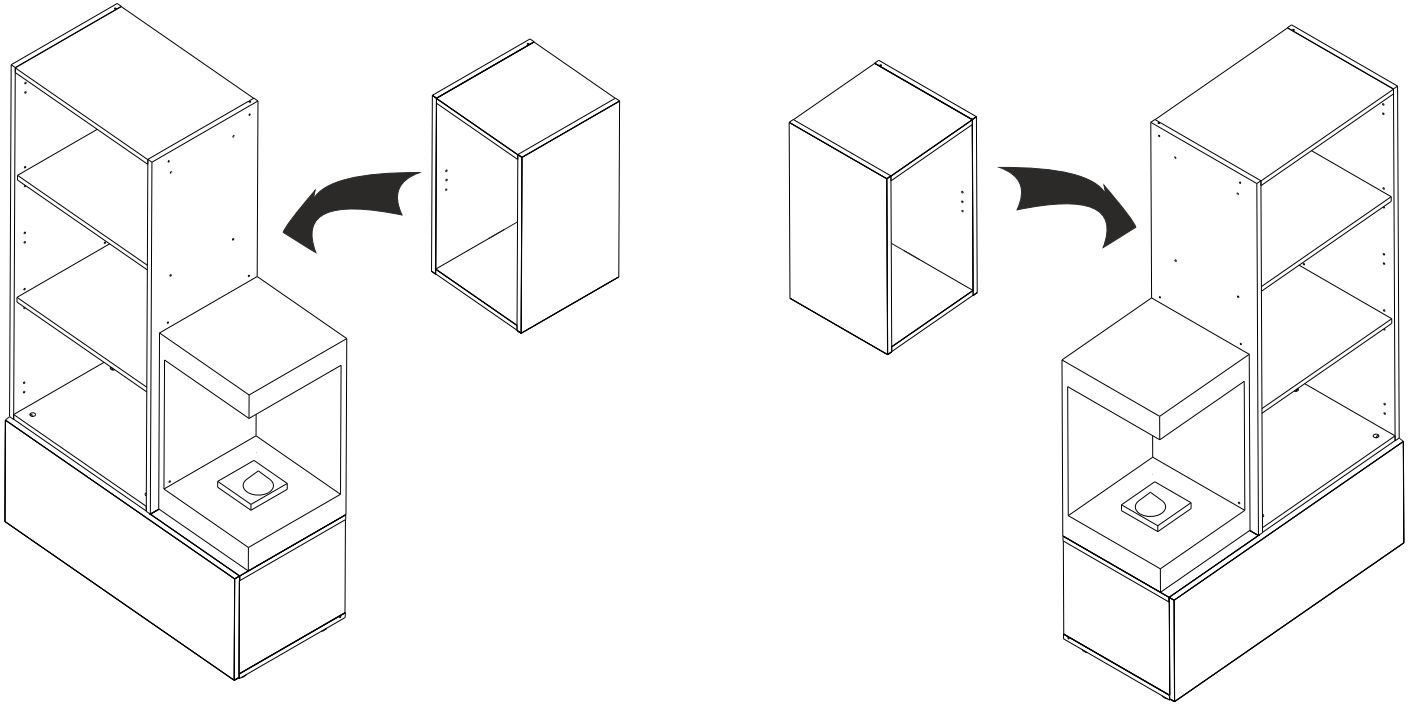
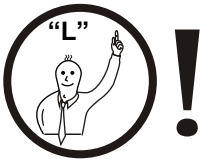

10

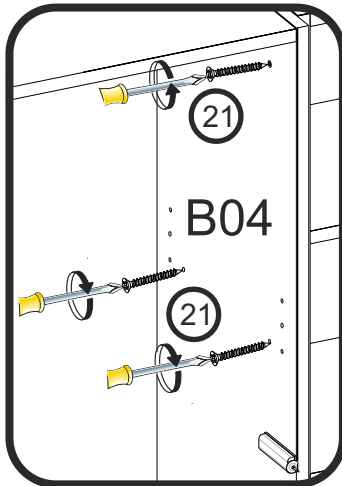
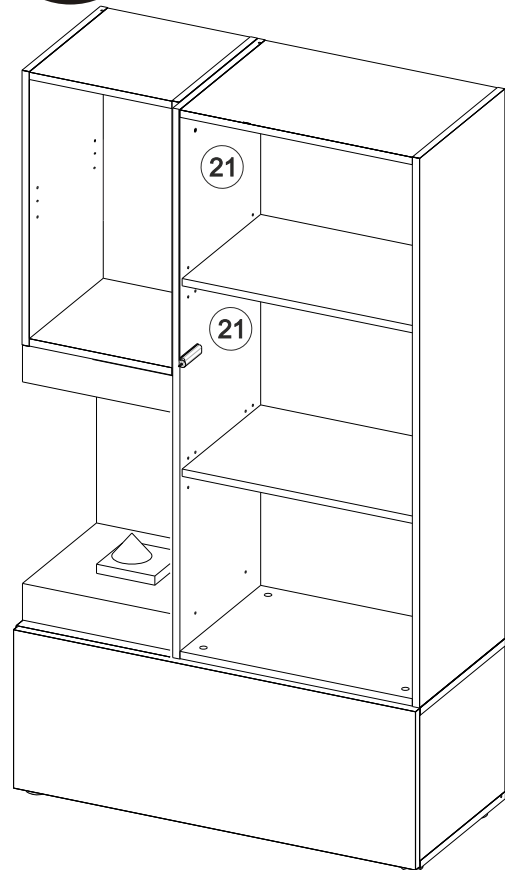
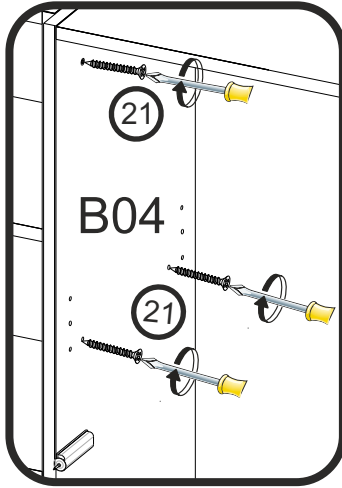
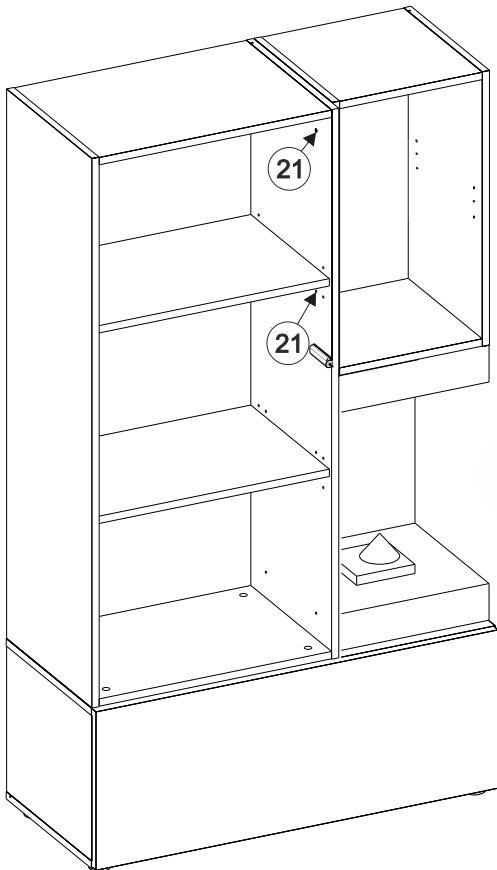
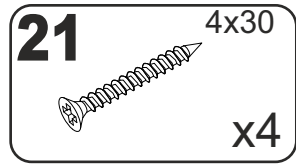

# 11

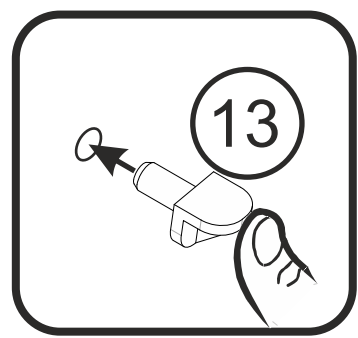
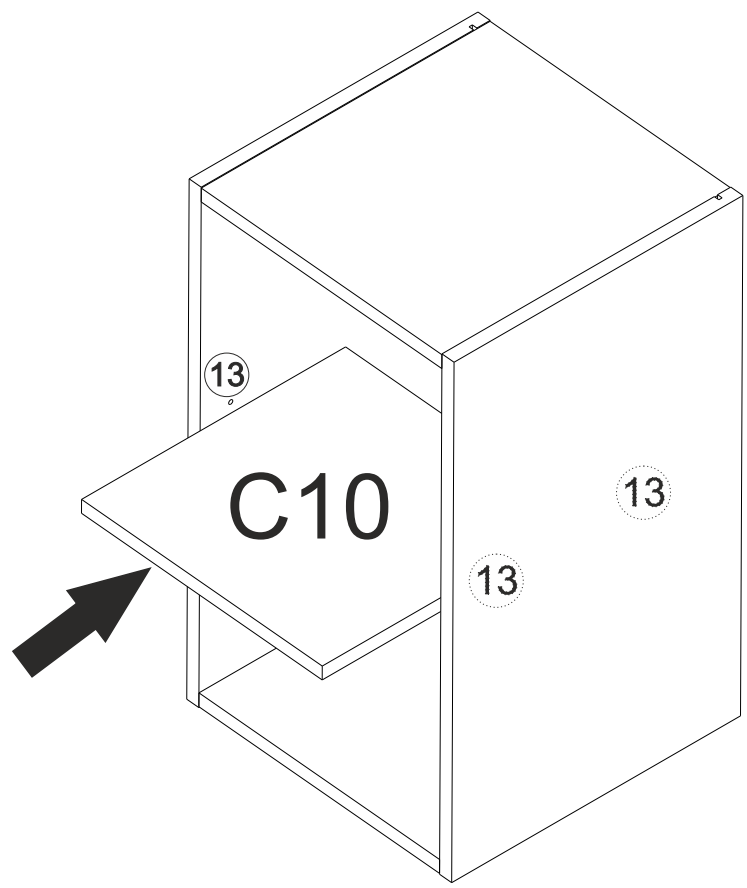
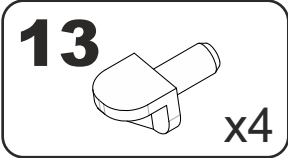

# C

