

180 min

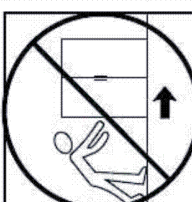

FR
Pensez à donner ou recycler.
 Association ou Magasin ou Déchèterie

<https://quefairedemesdechets.fr>

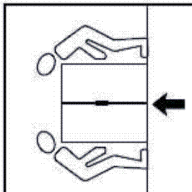
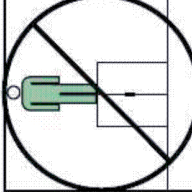
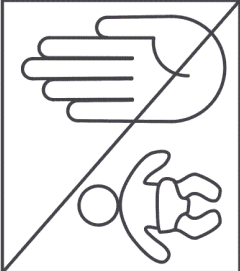
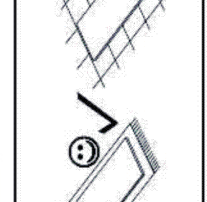
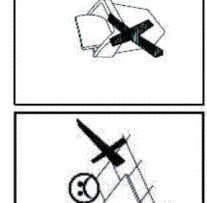
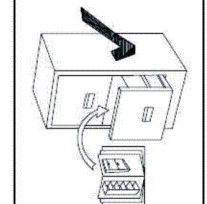
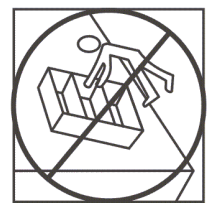
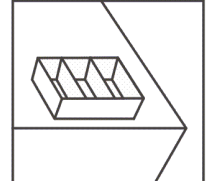
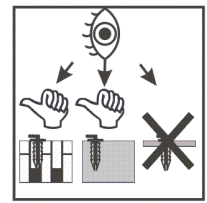
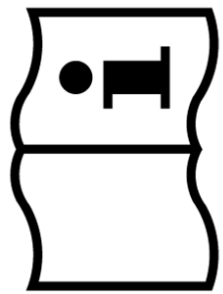
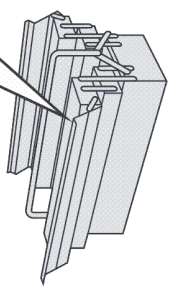
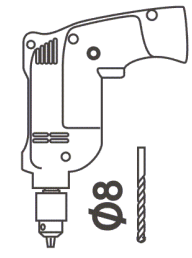
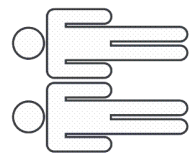
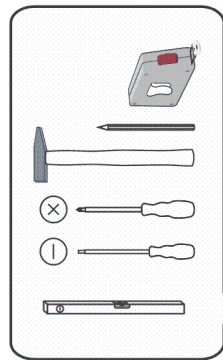
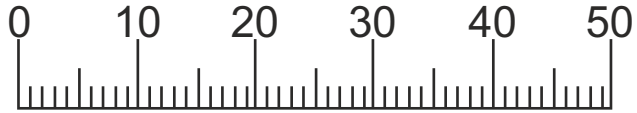
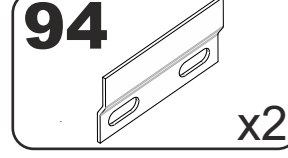
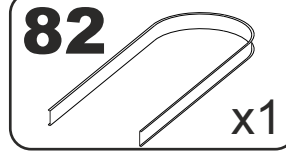
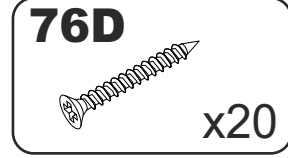
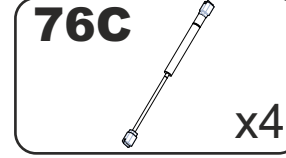
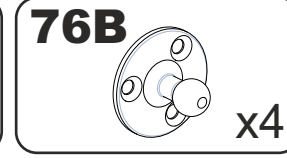
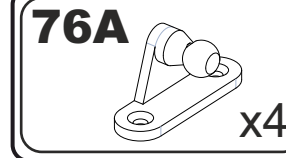
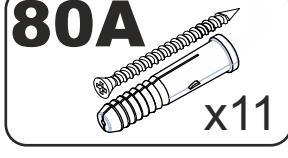
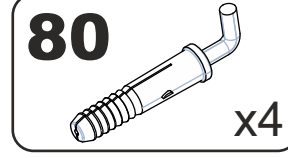
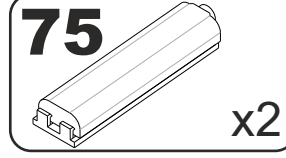
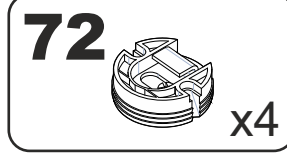
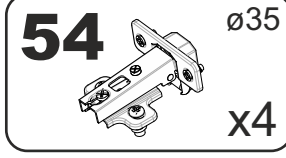
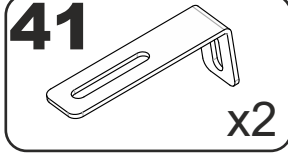
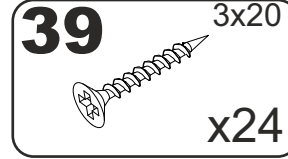
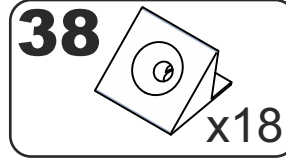
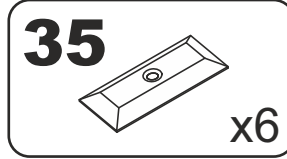
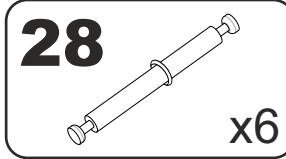
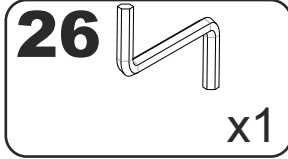
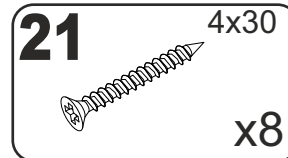
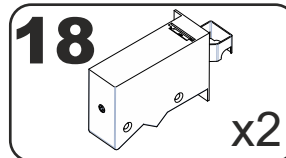
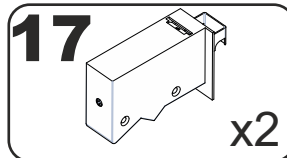
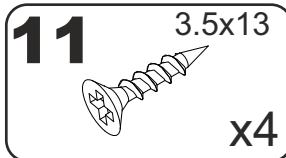
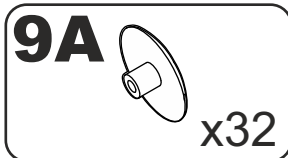
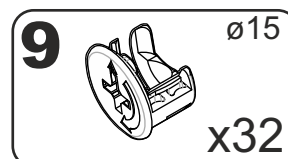
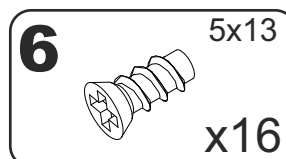
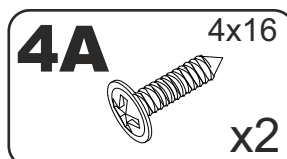
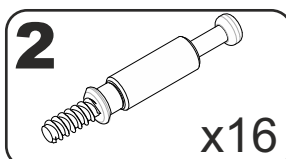
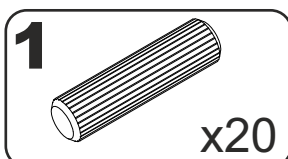
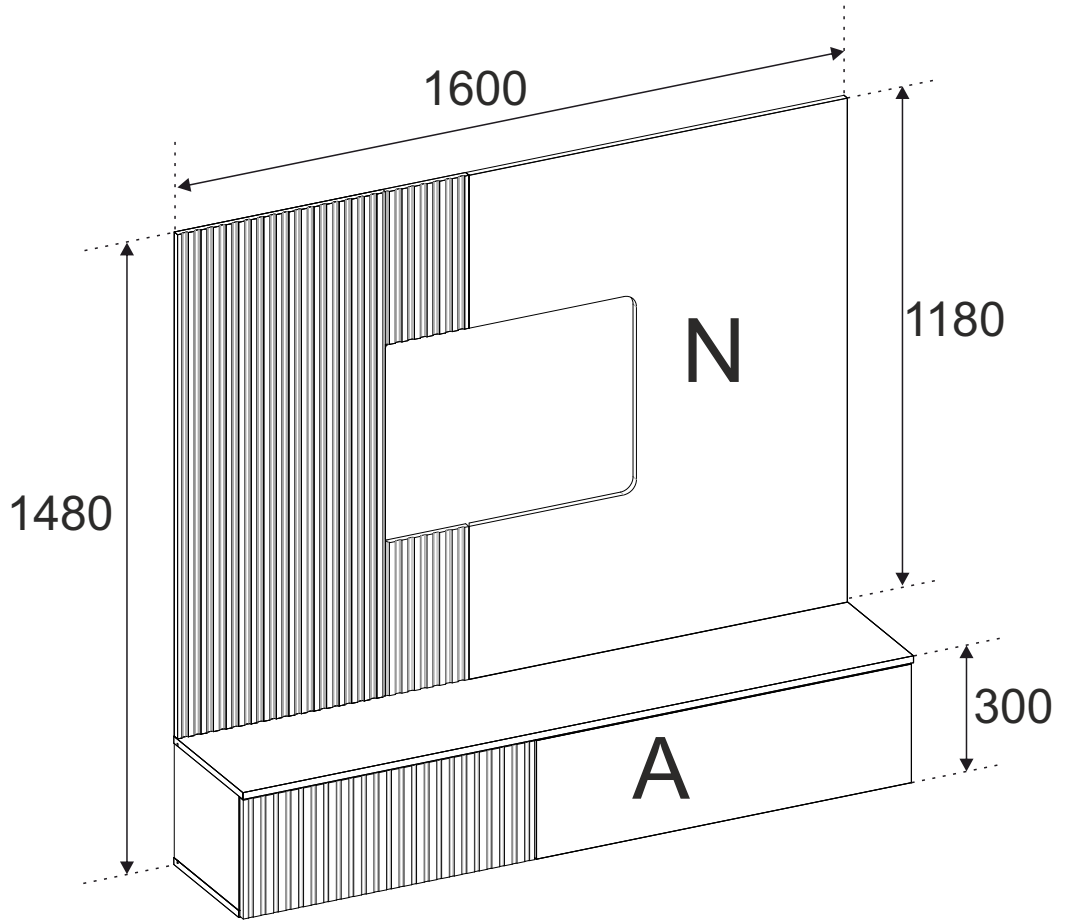
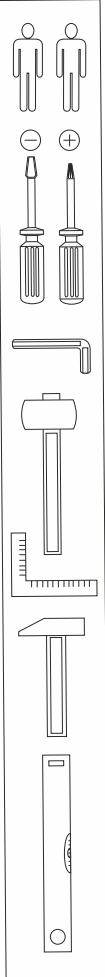

A

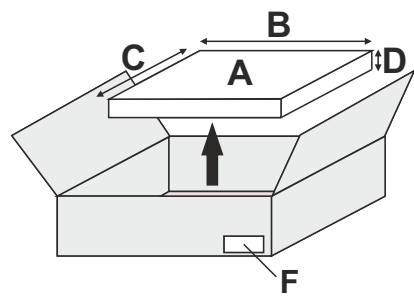
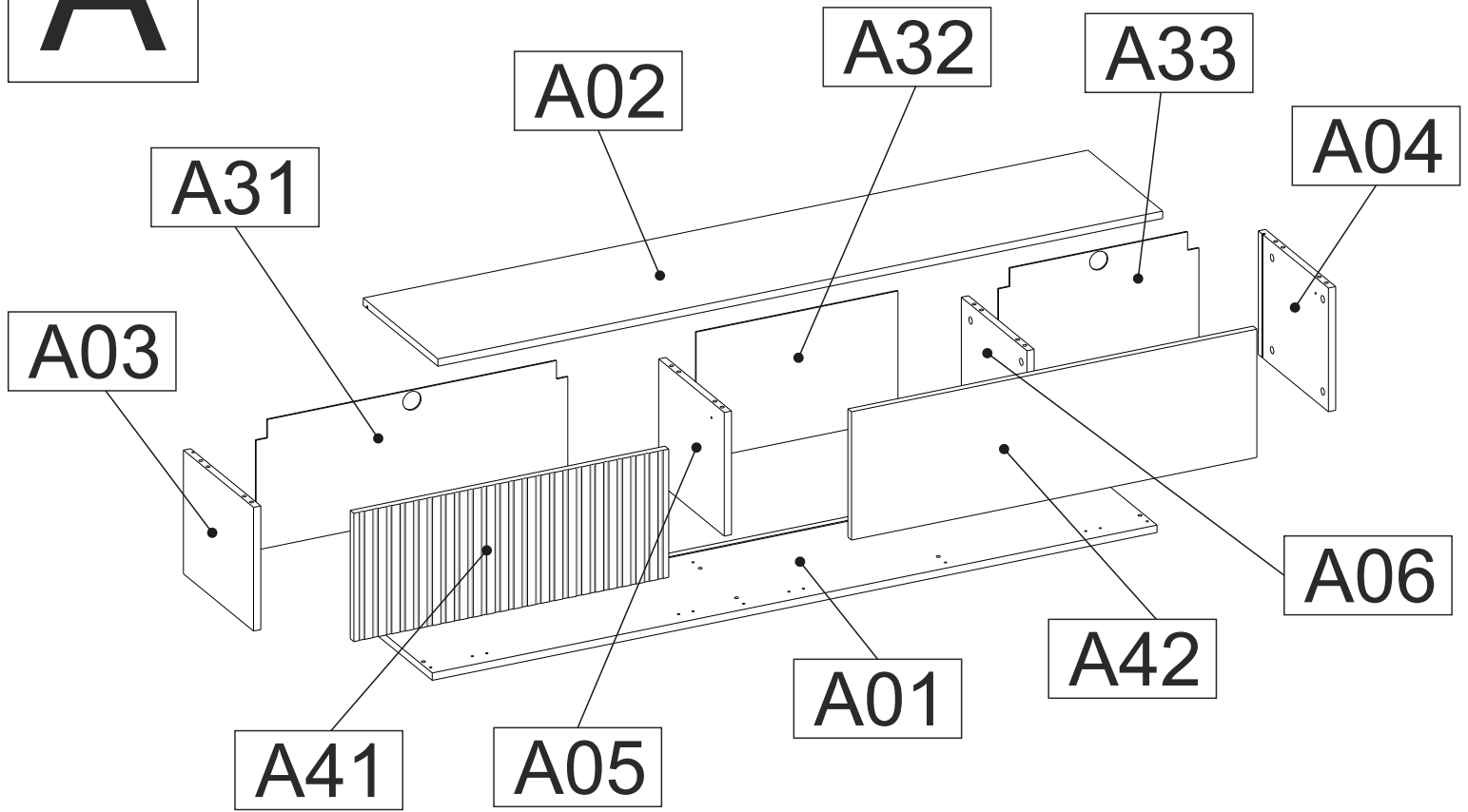

A	B_(mm)	C_(mm)	D_(mm)	E	F
A01	1602	310	16	1	1 2
A02	1602	330	16	1	1 2
A03	268	310	16	1	1 2
A04	268	310	16	1	1 2
A05	290	268	16	1	1 2
A06	290	268	16	1	1 2
A31	689	278	3	1	1 2
A32	446	278	3	1	1 2
A33	443	278	3	1	1 2
A41	278	696	16	1	1 2
A42	278	896	16	1	1 2

1

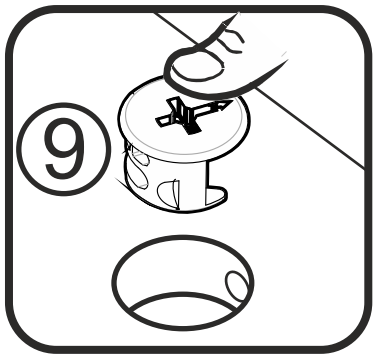
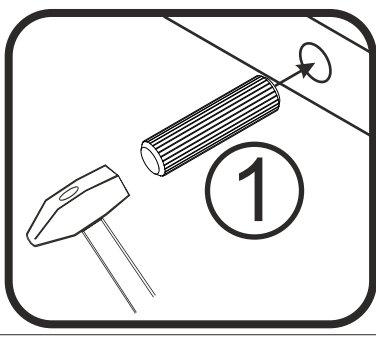
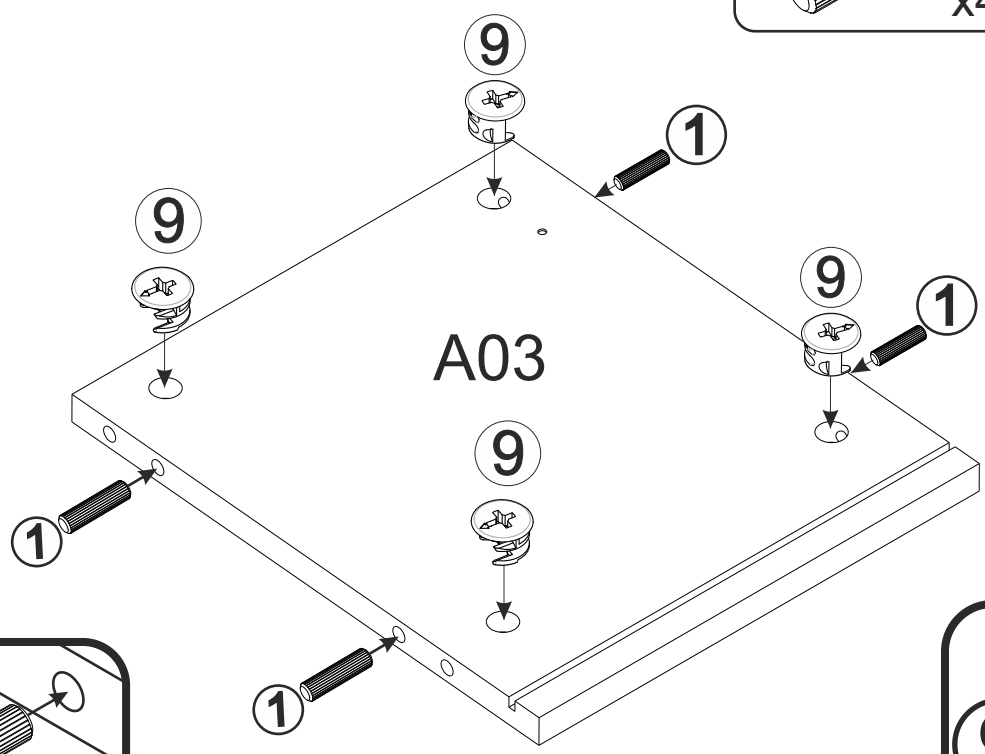
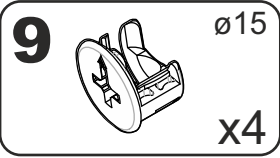
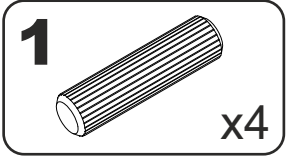

2

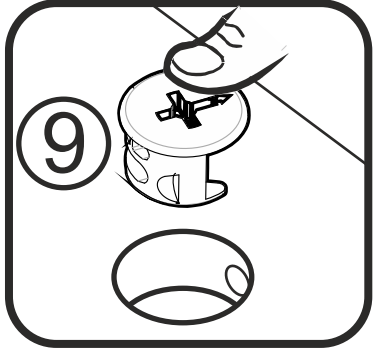
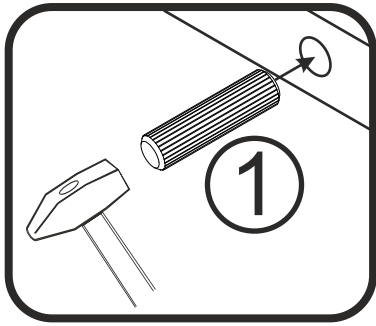
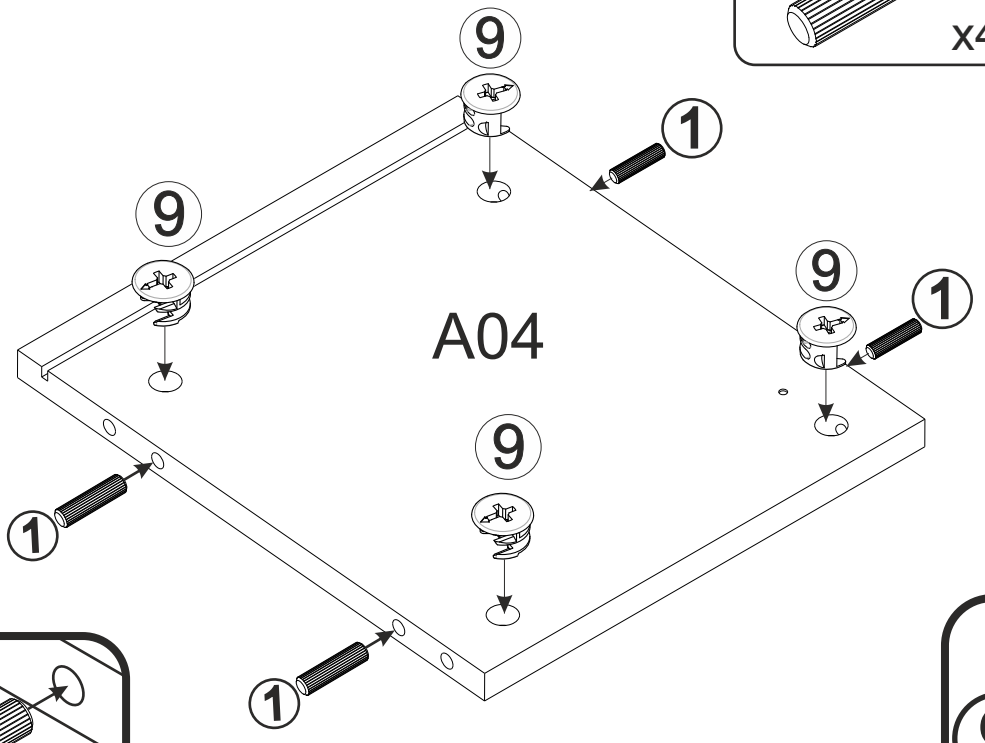
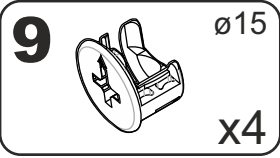
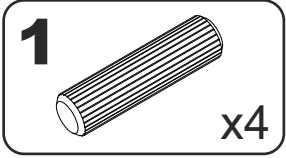

3

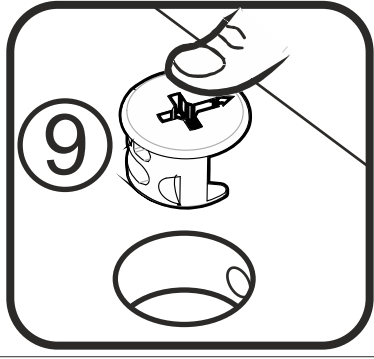
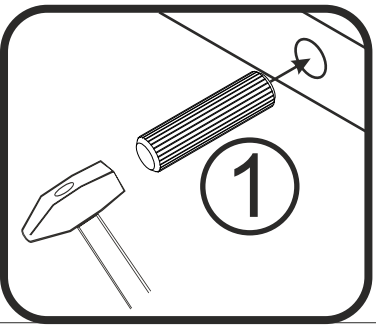
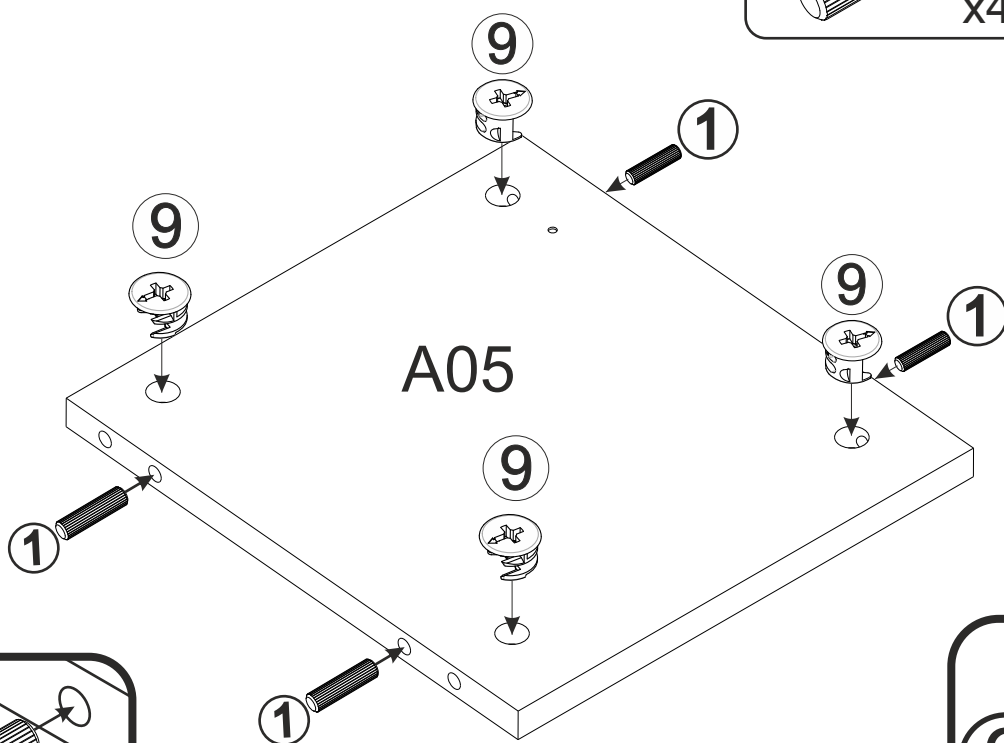
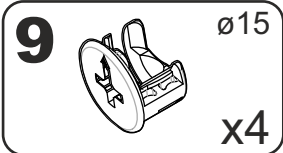
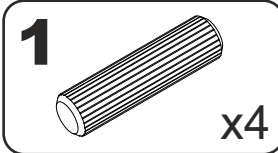

4

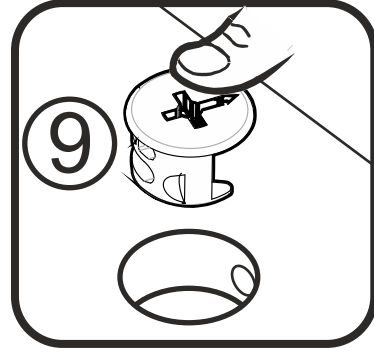
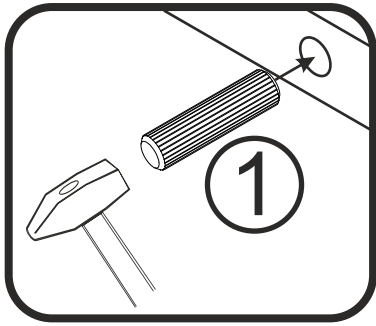
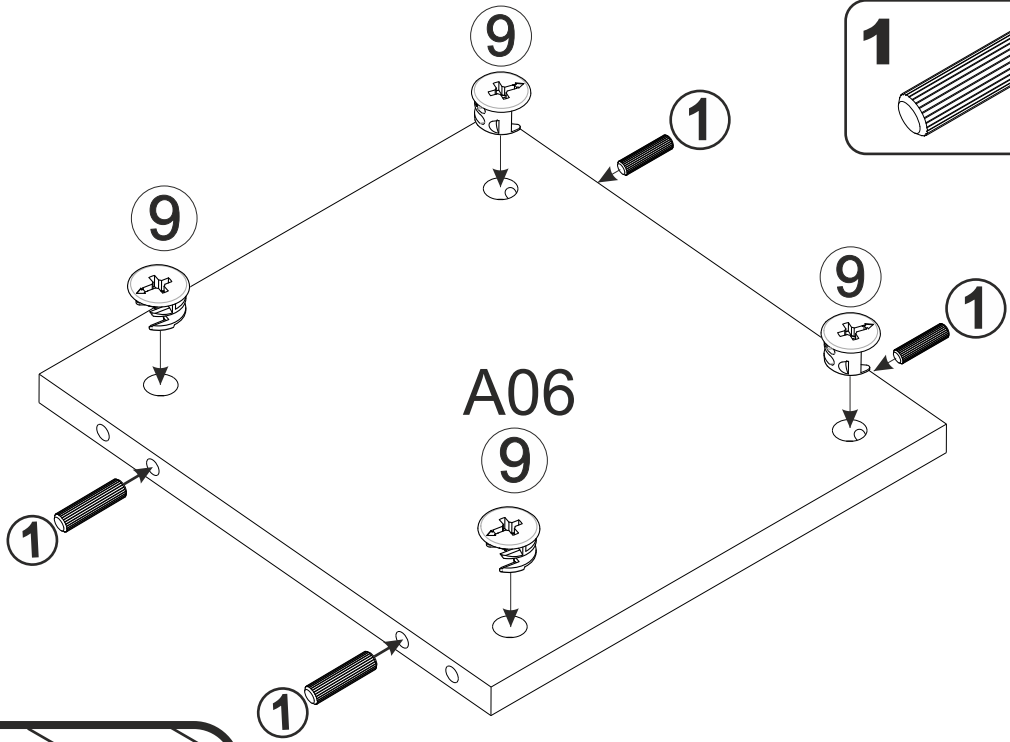
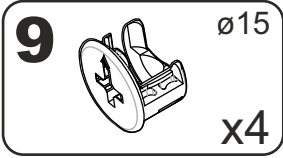
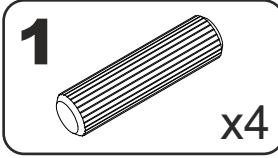

5

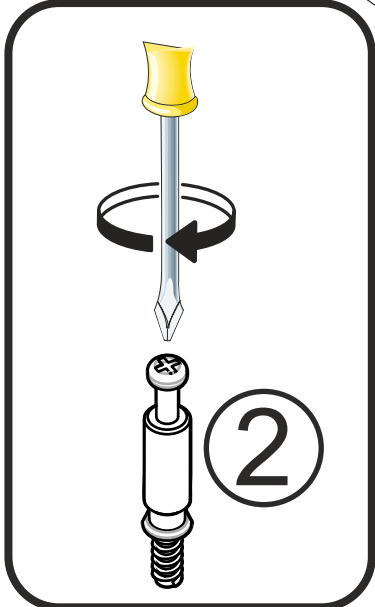
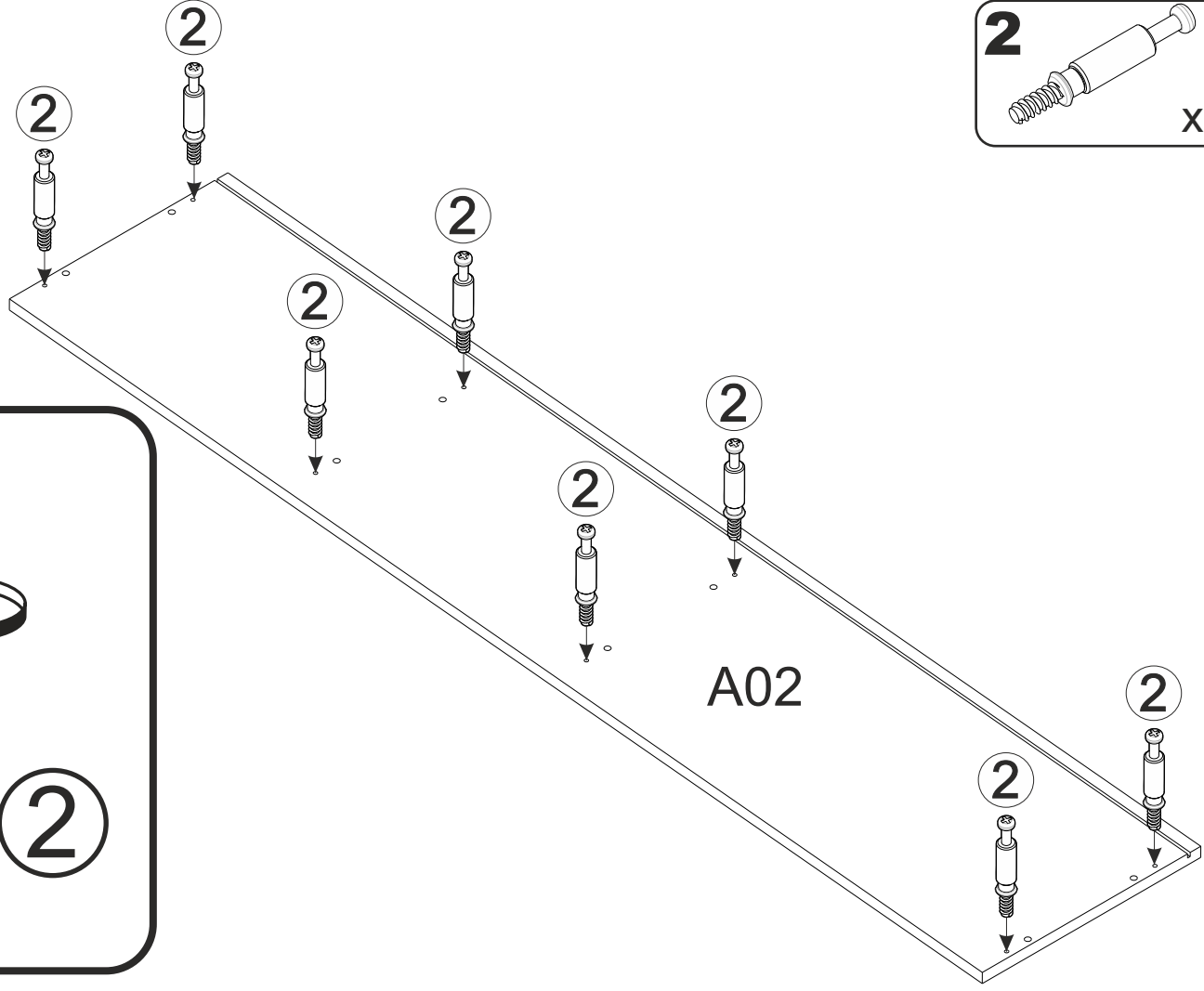
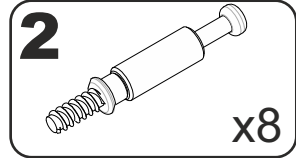

6

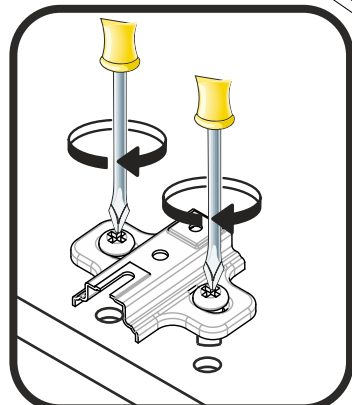
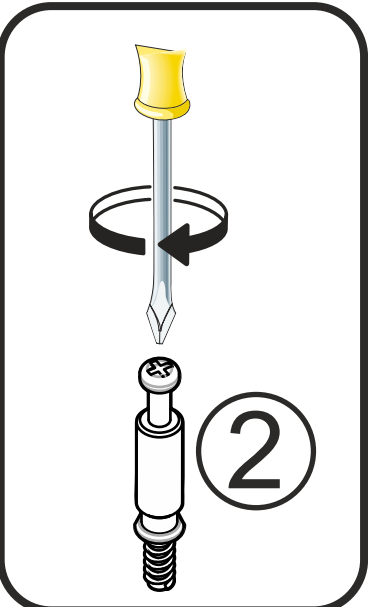
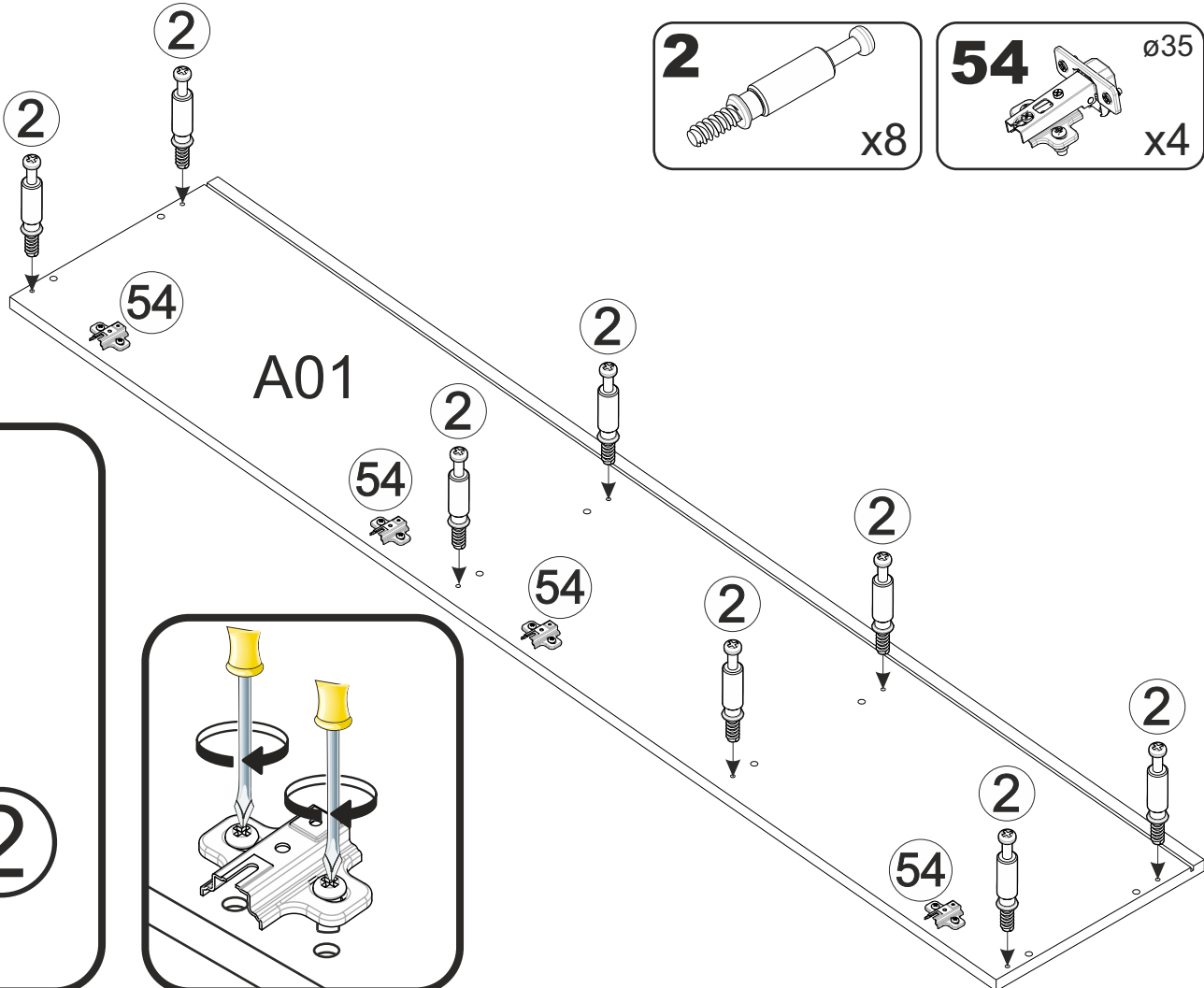
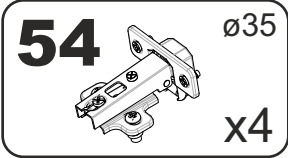
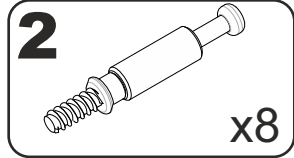

6 5x13
x4

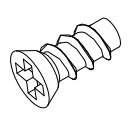

54 ø35
x2

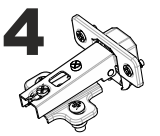
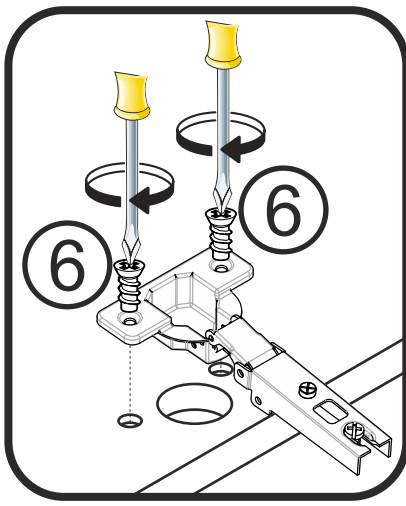
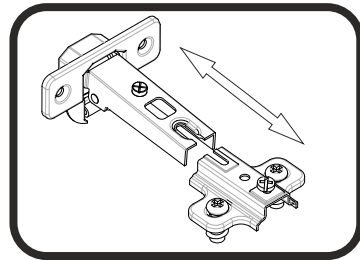
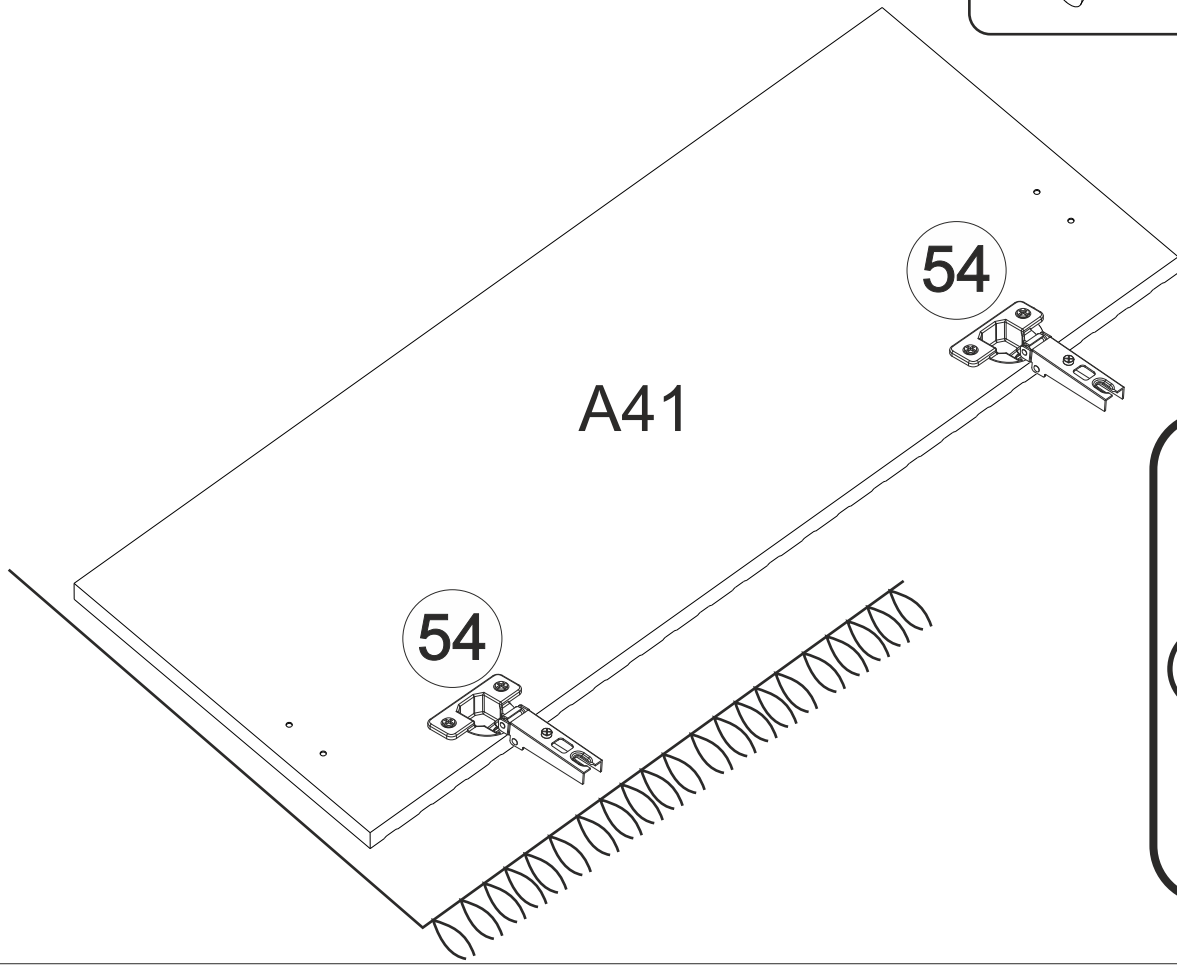
6 5x13
x4

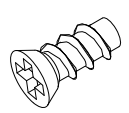

54 ø35
x2

9

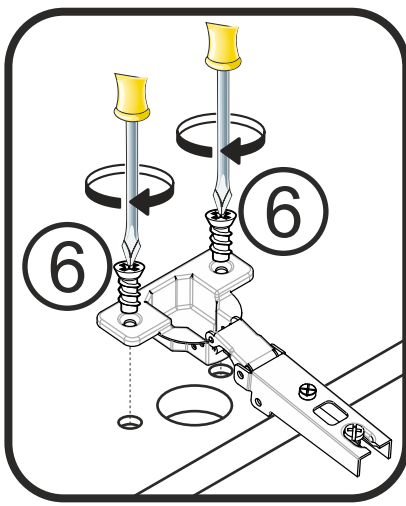
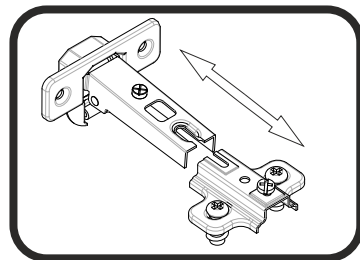
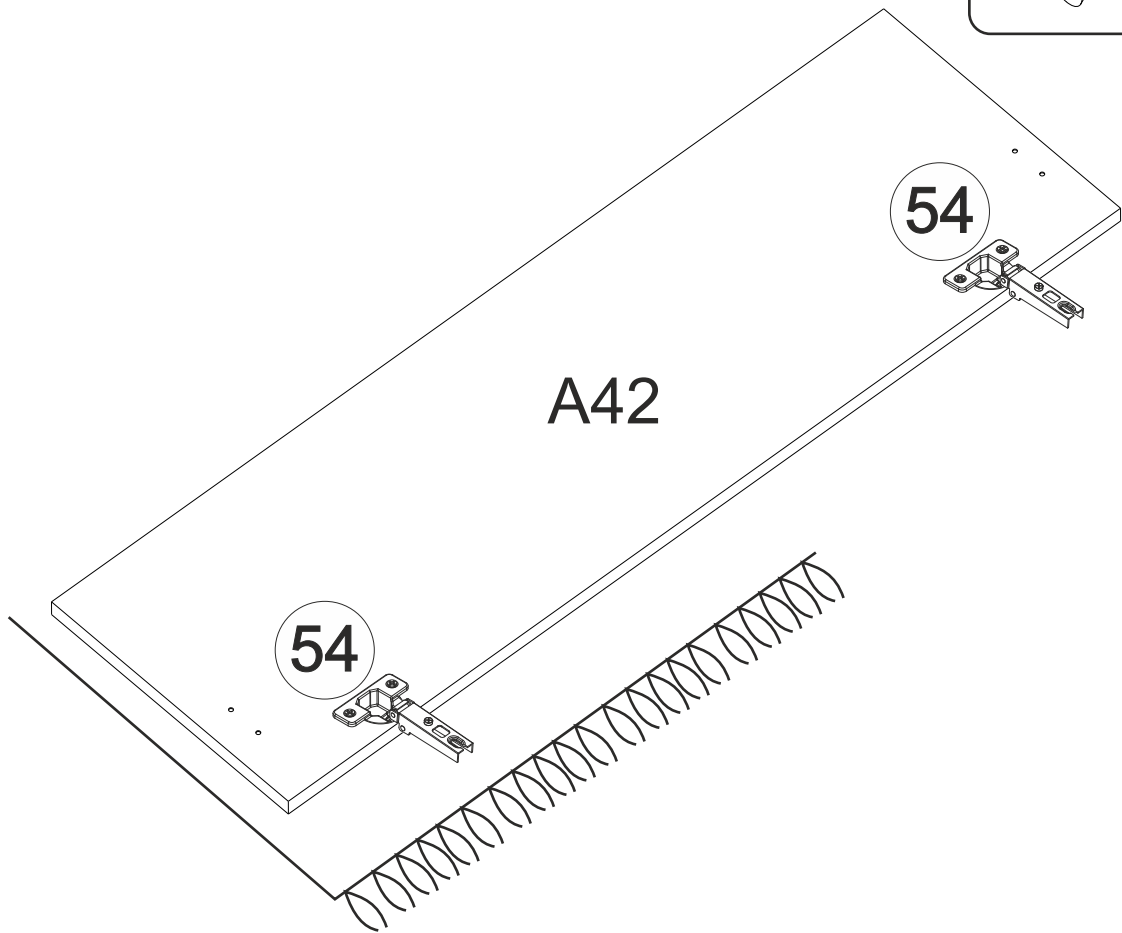

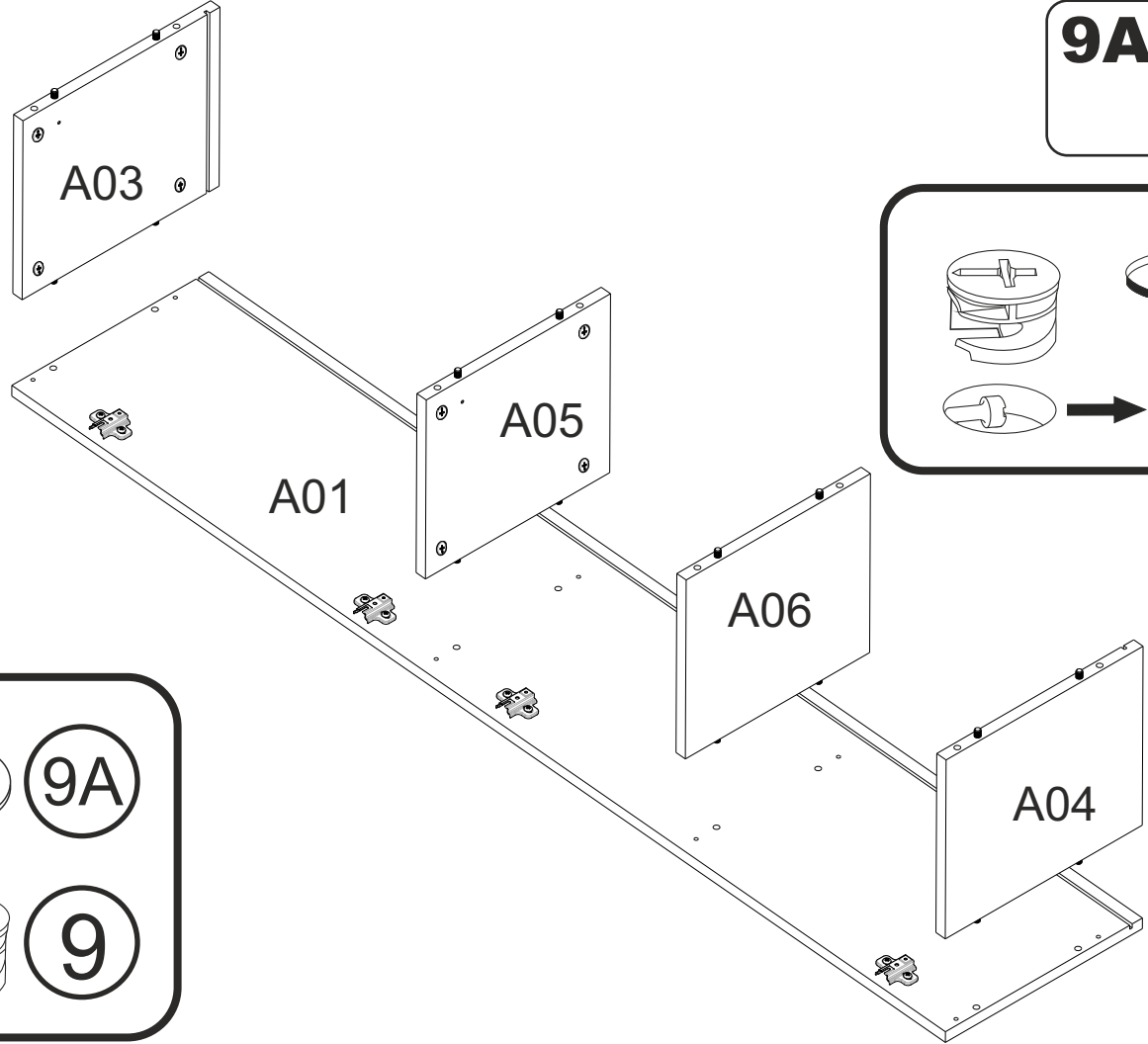
10

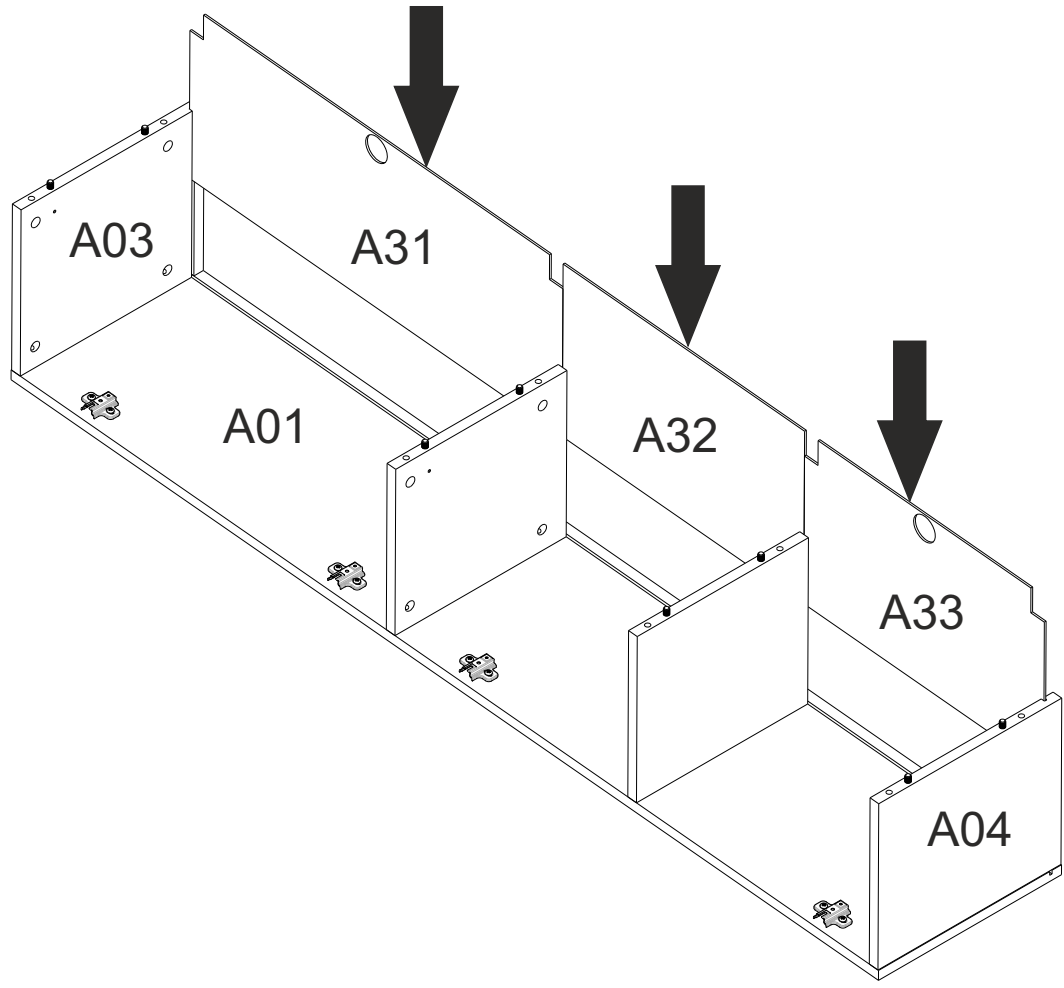

11

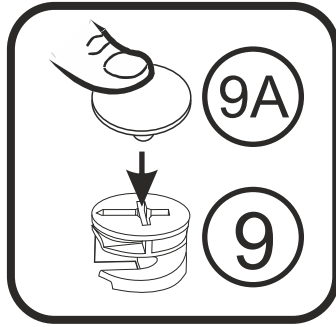
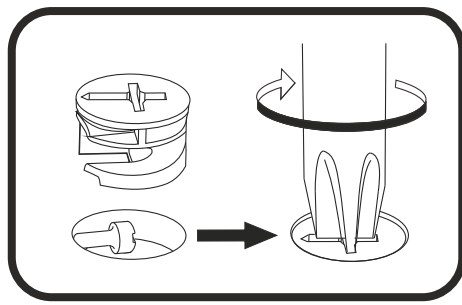
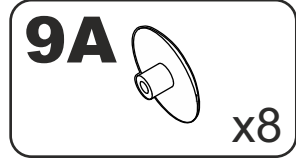
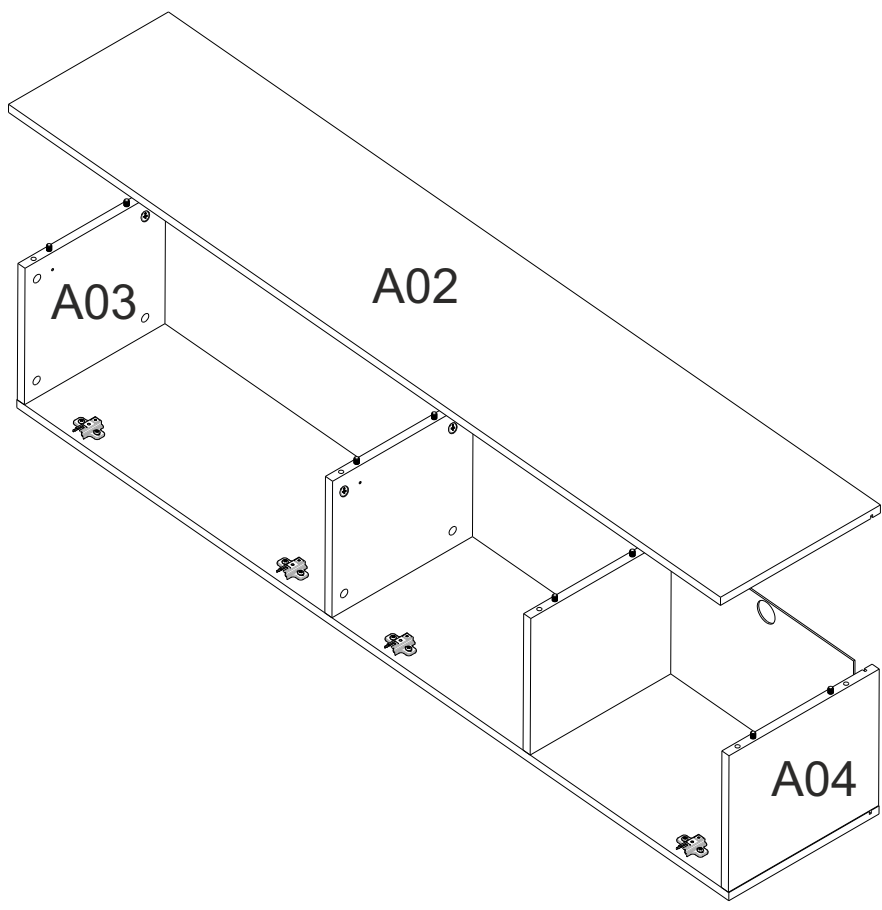

12

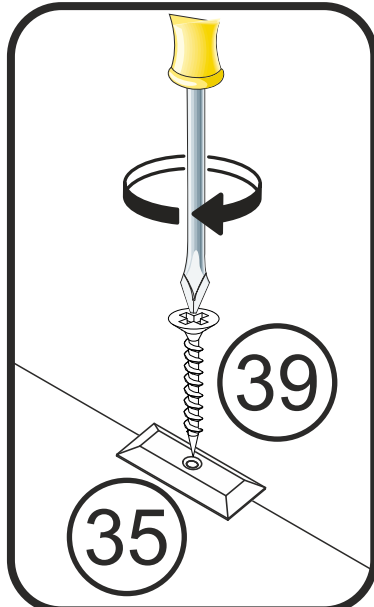
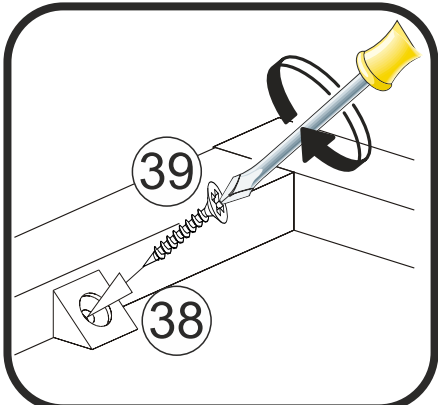
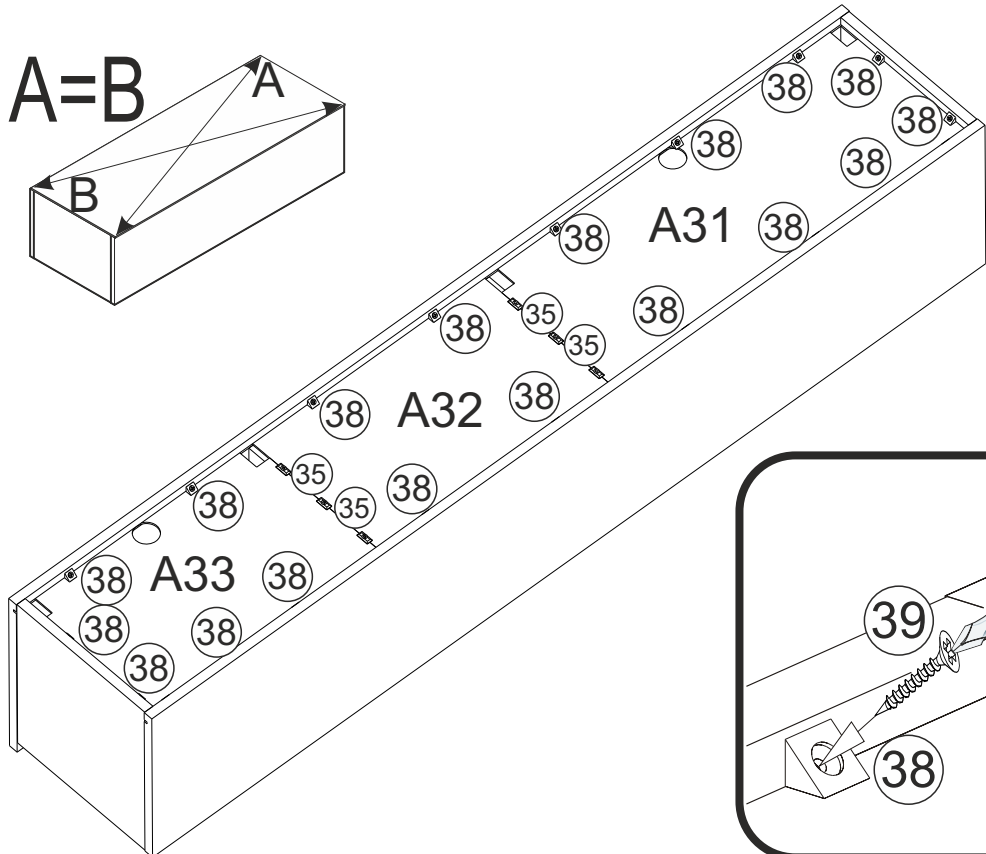
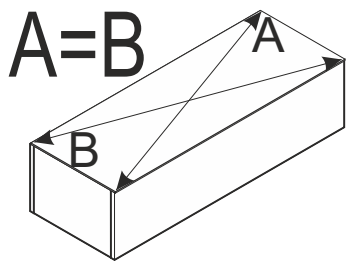
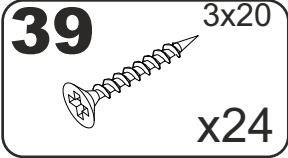
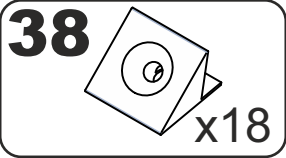
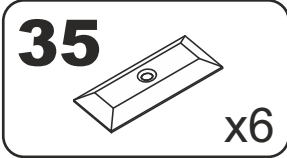

13

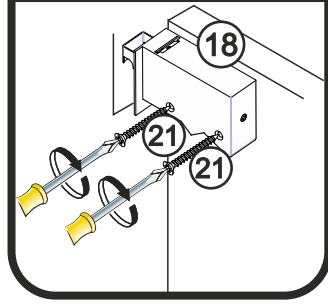
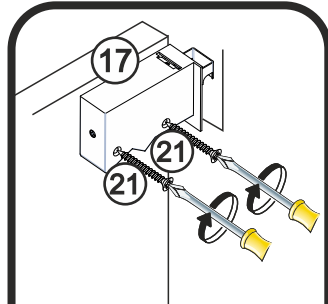
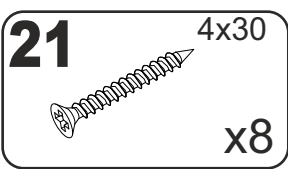
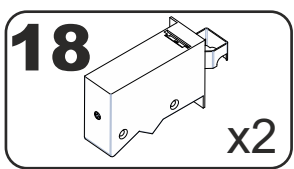
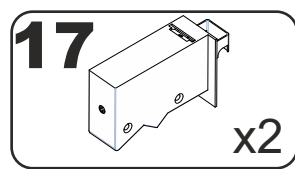
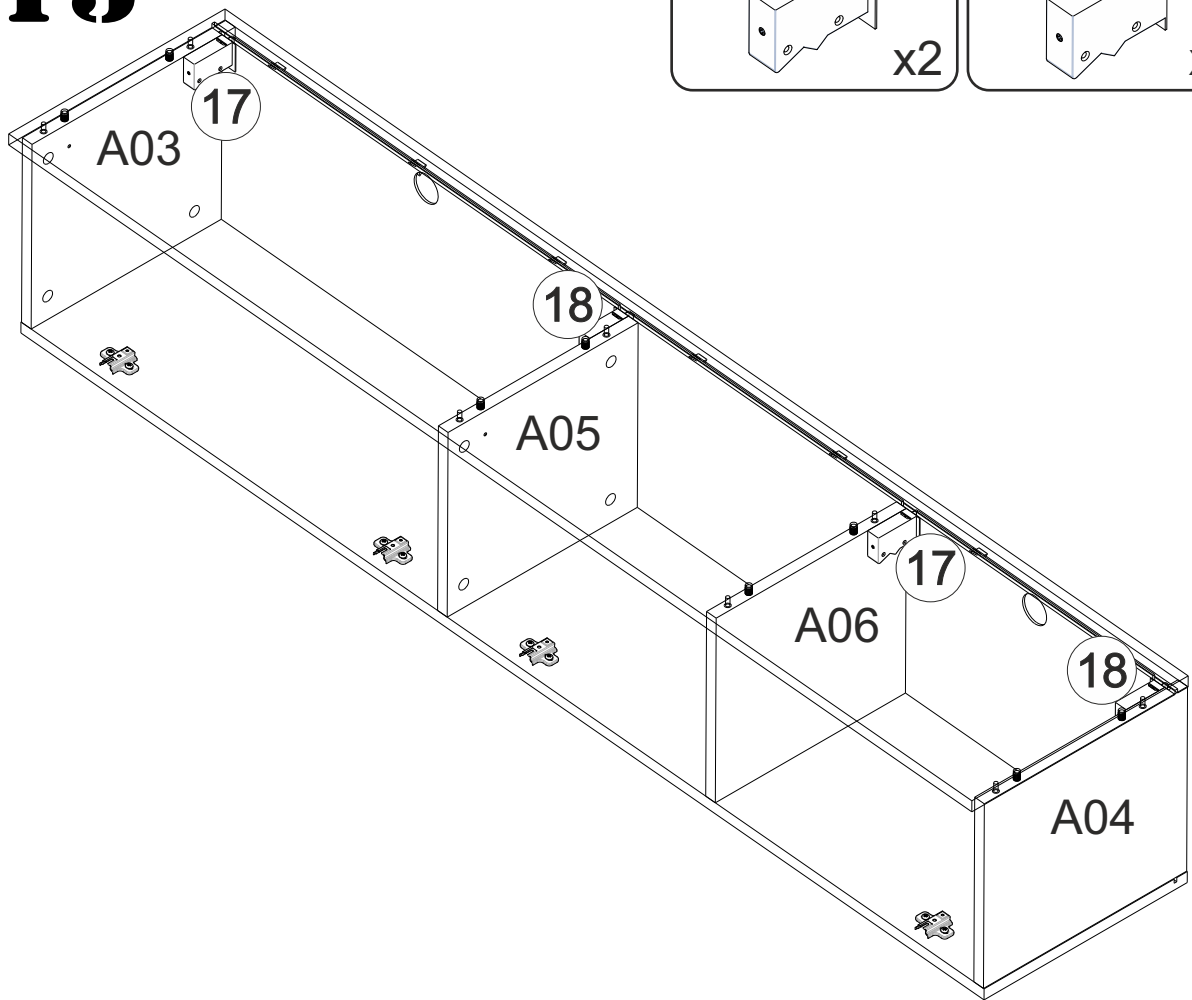

14

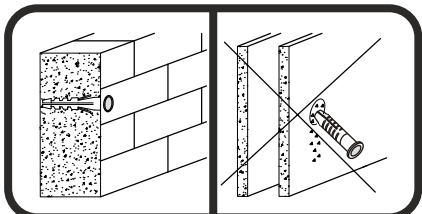
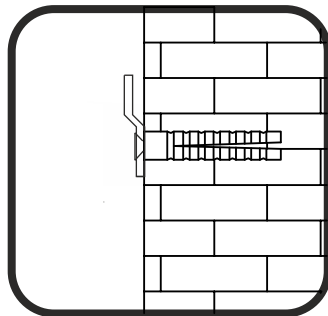
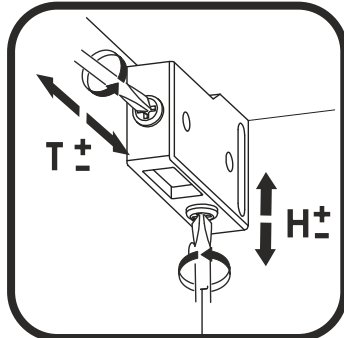
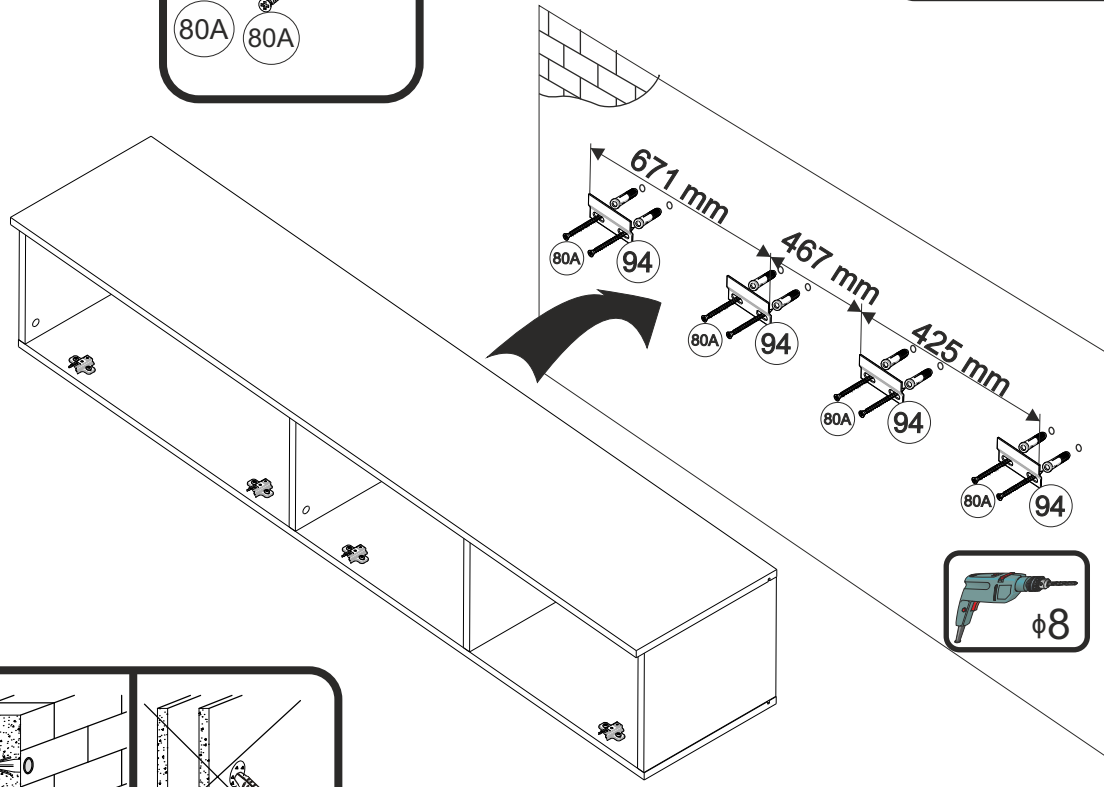
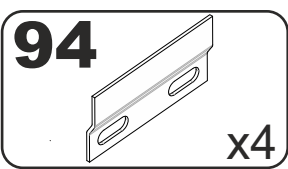
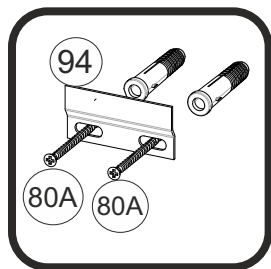

15

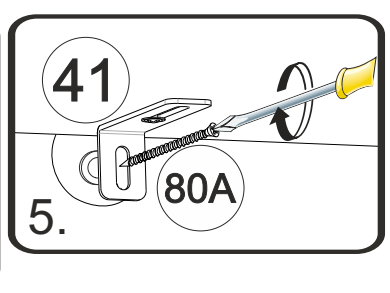
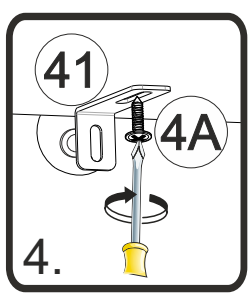
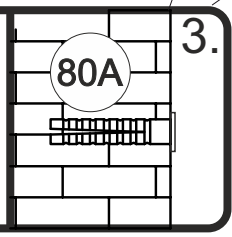
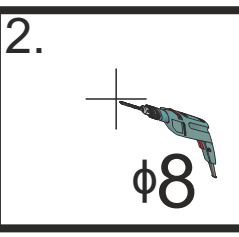
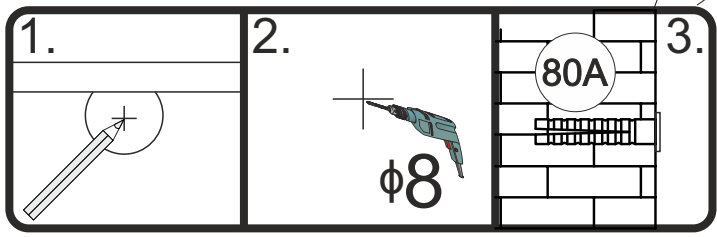
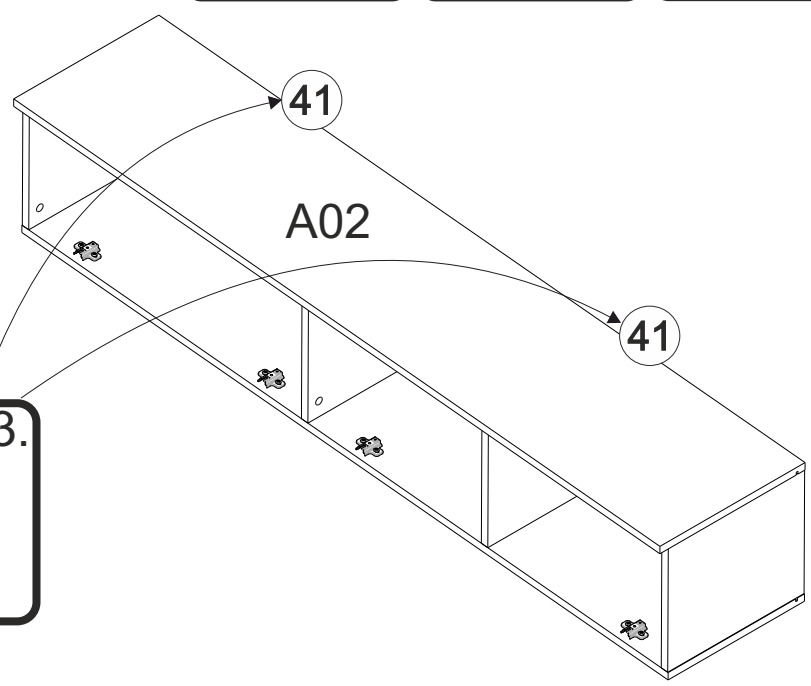
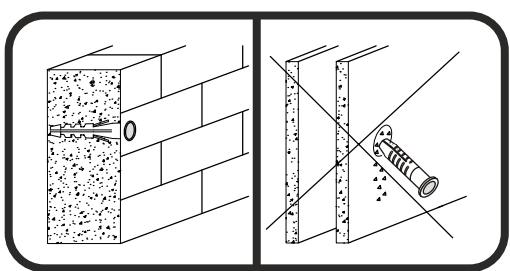
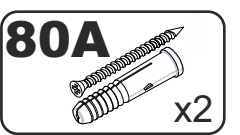
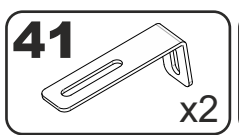
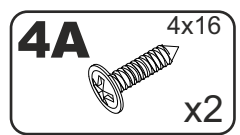

16

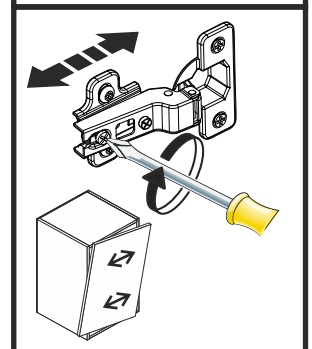
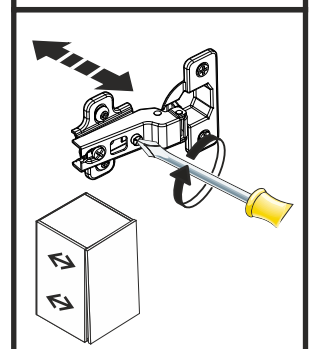
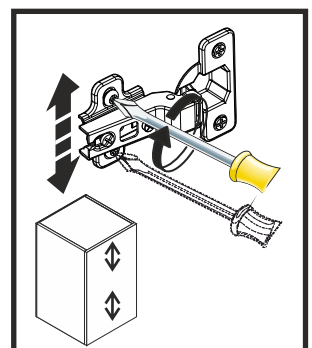
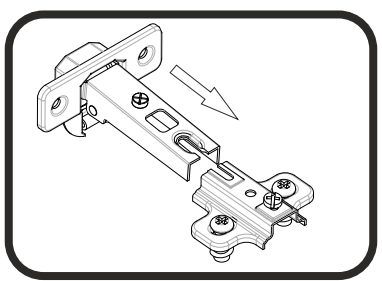
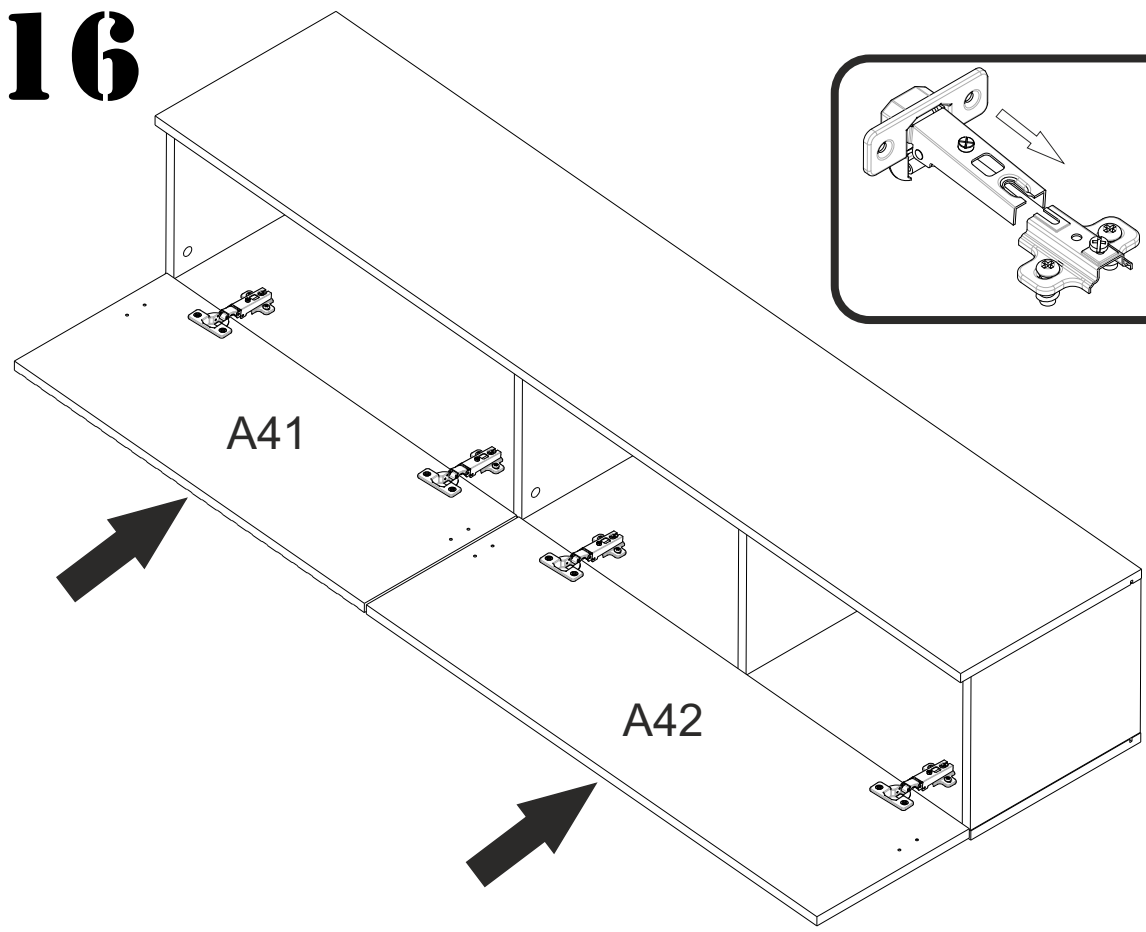

17

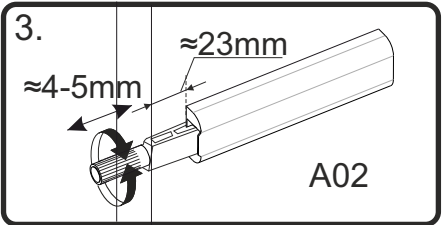
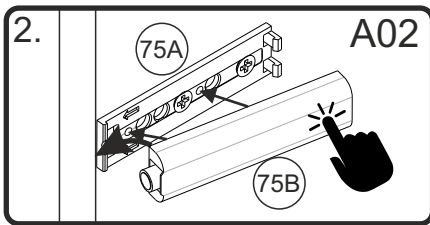
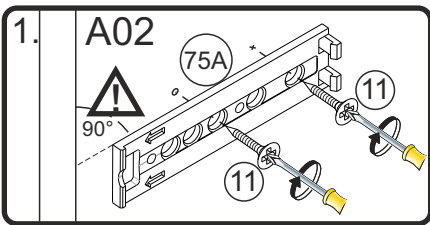
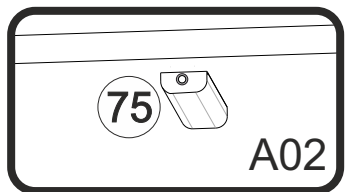
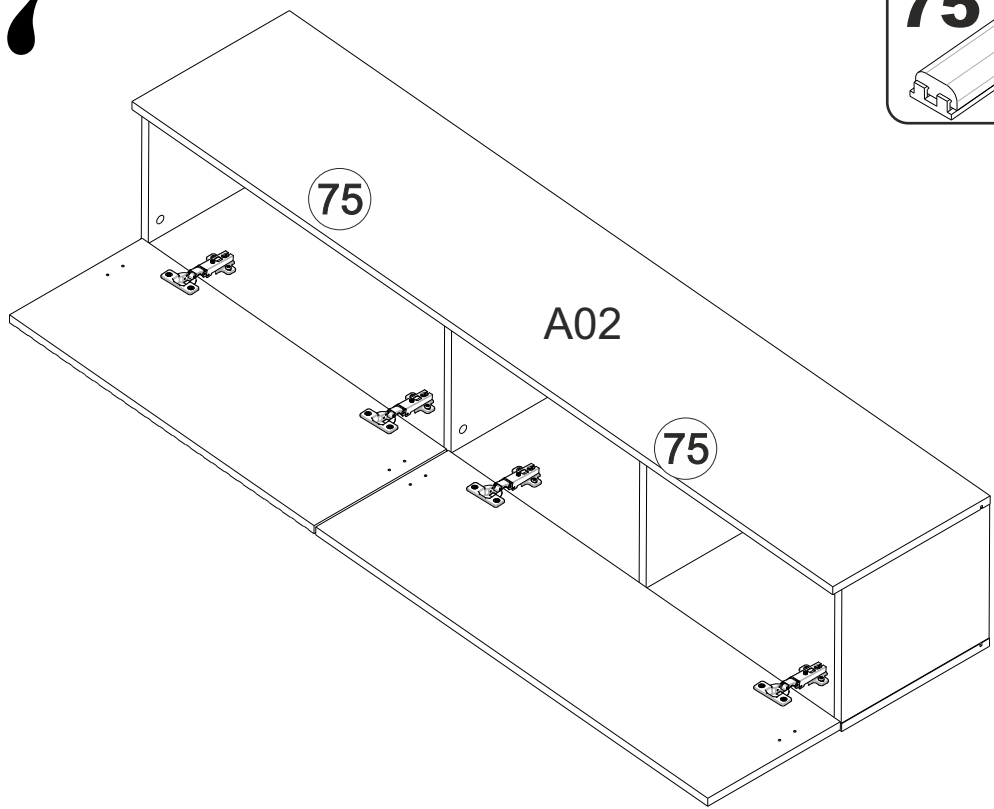
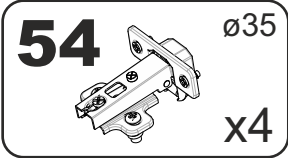
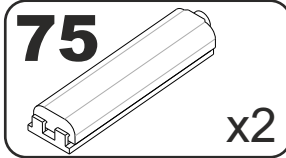

18

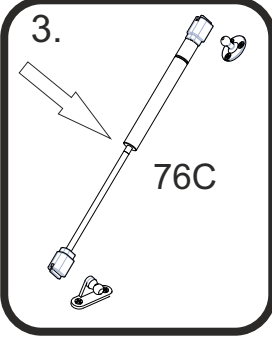
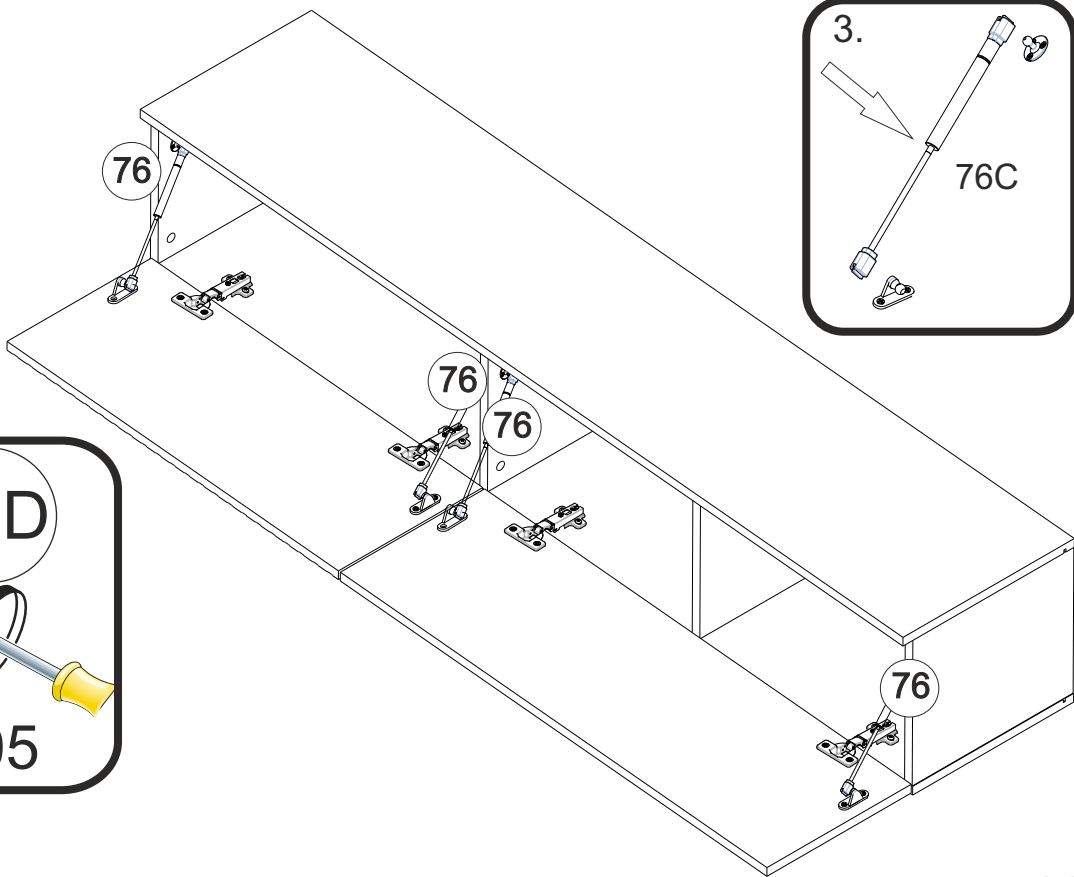
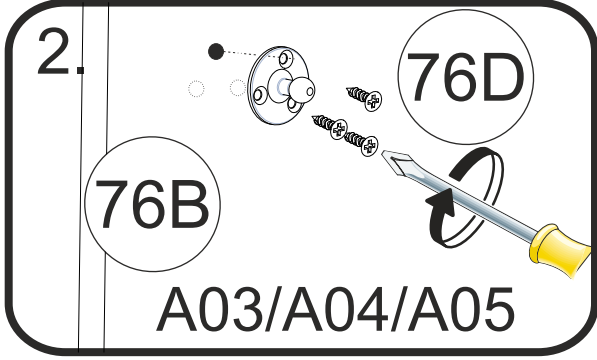
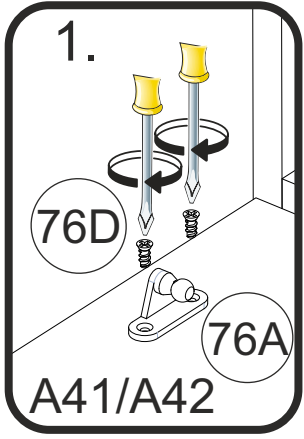
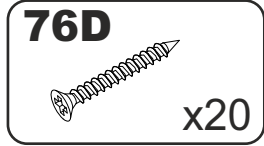
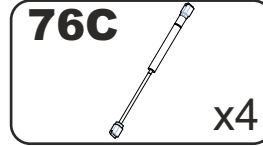
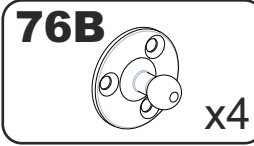
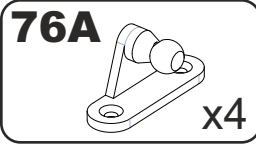

A

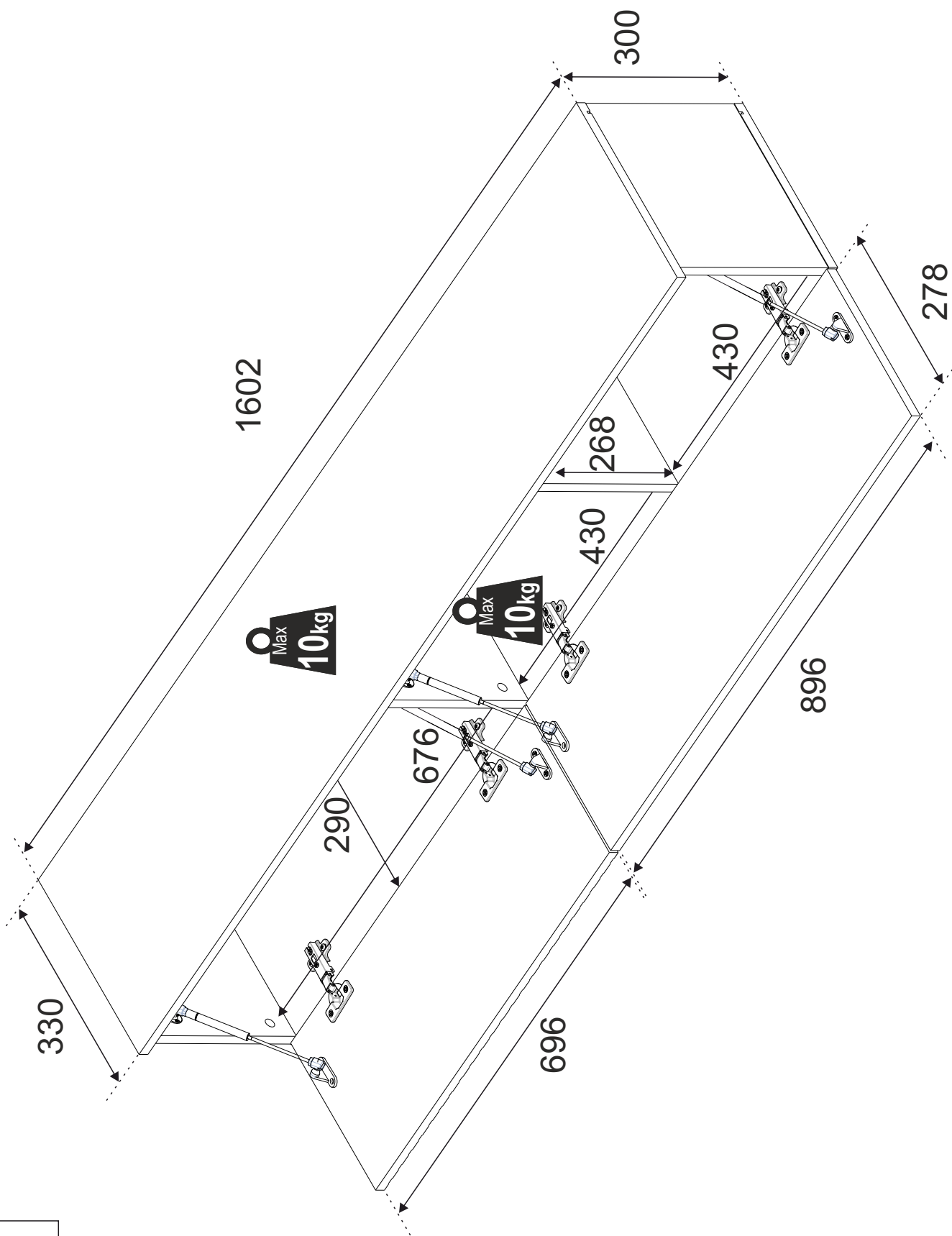
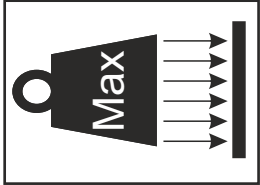

N

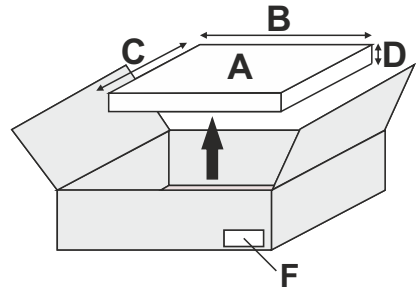
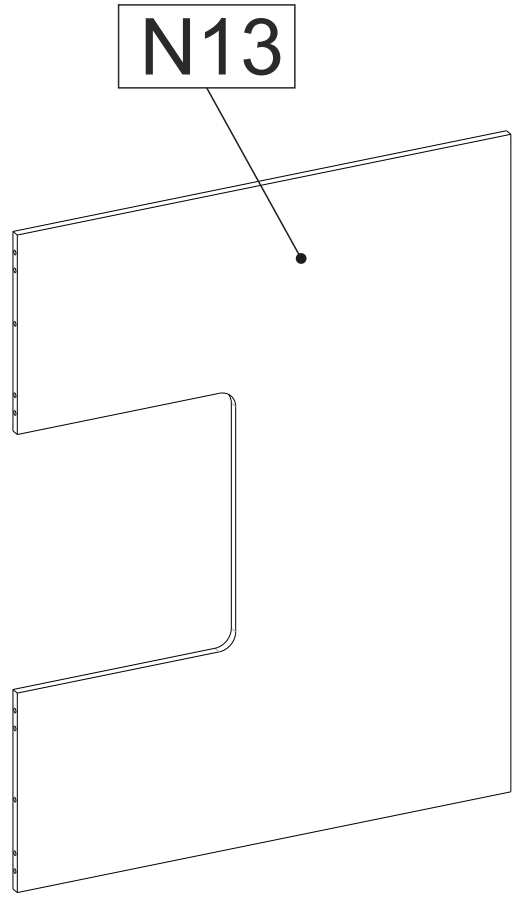
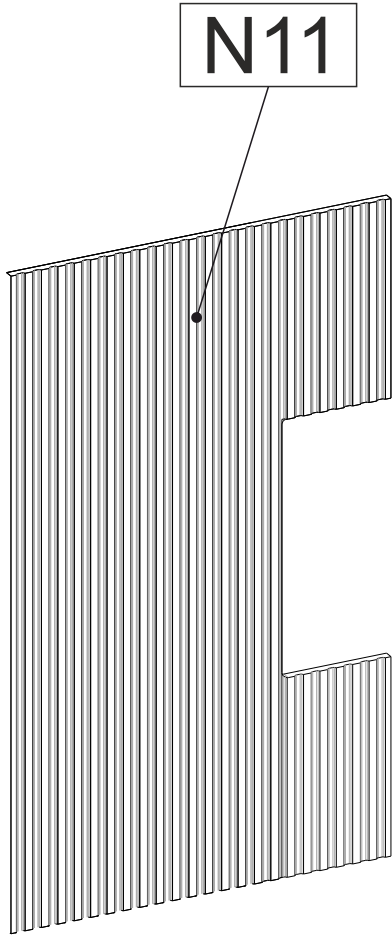

A	B_(mm)	C_(mm)	D_(mm)	E	F
N11	1180	696	16	1	2 2
N13	1180	904	16	1	2 2

1

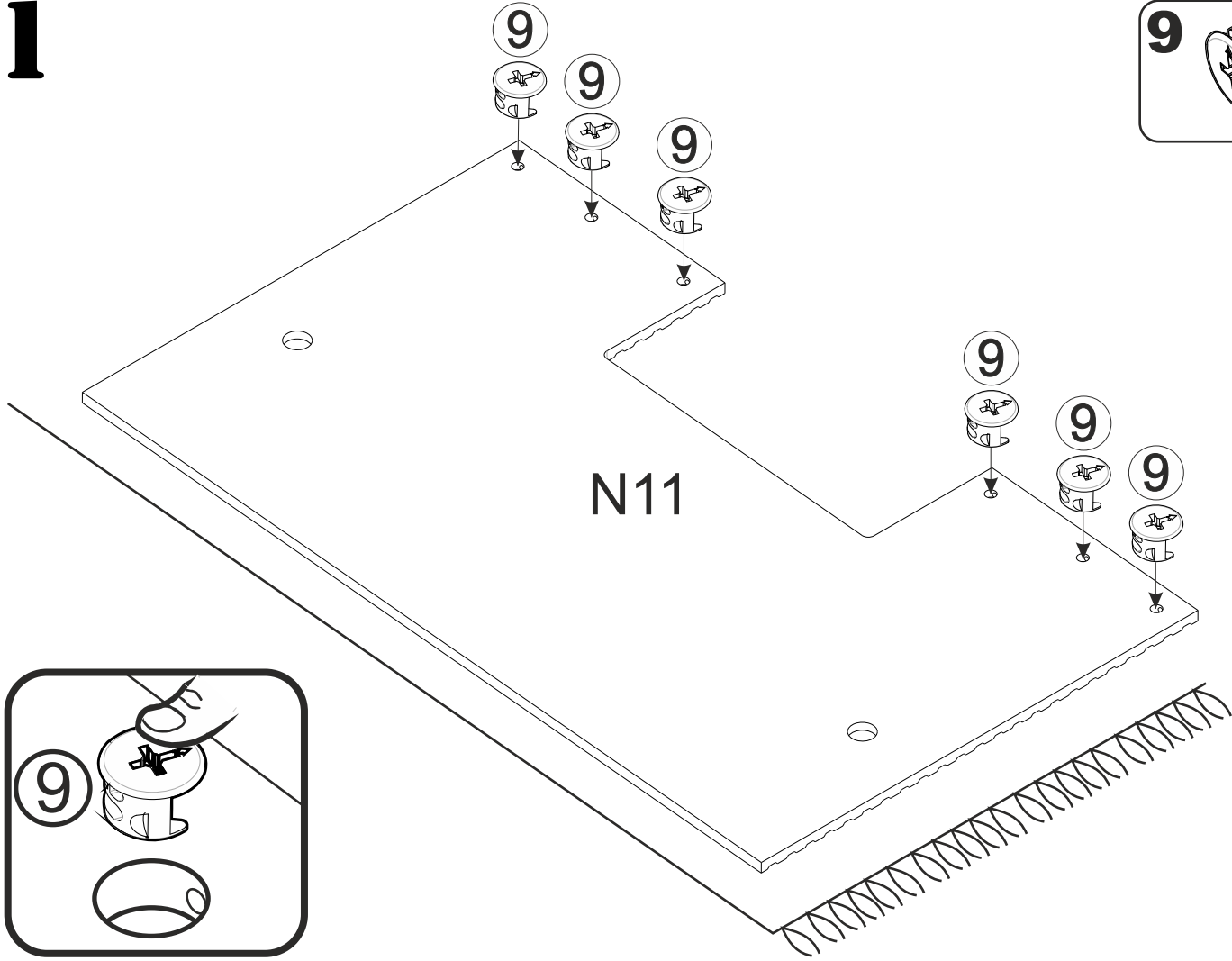

9 ø15
x6

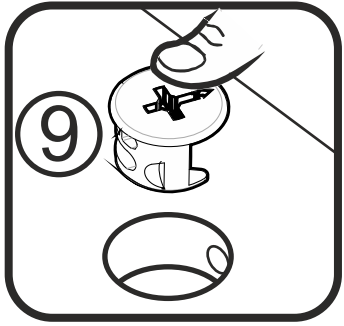

2

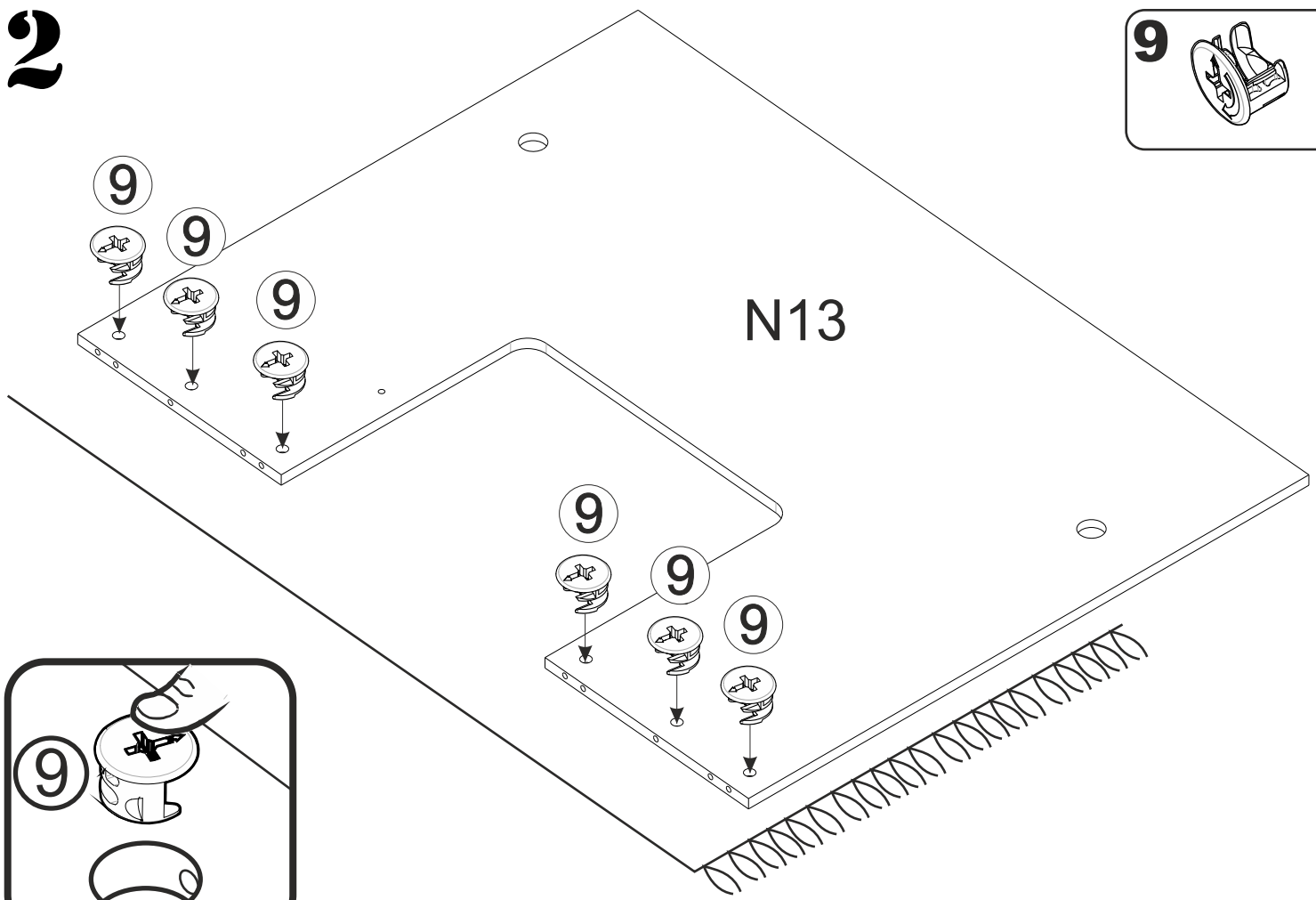

9 ø15
x6

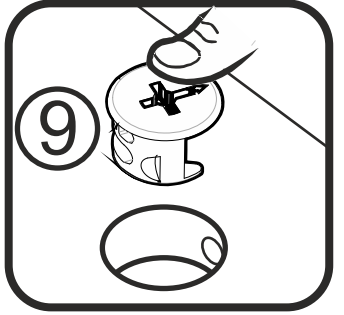

3

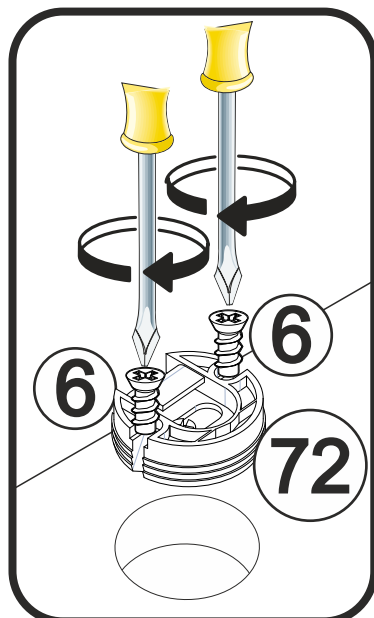
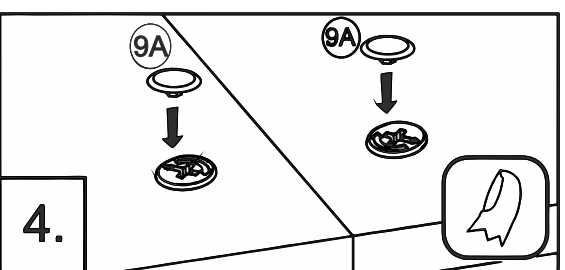
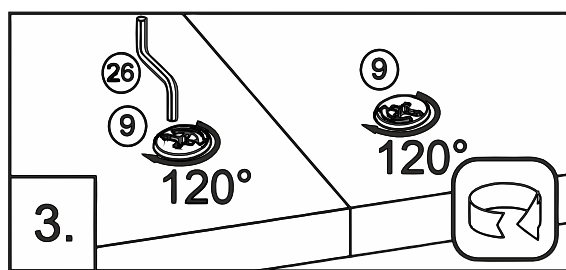
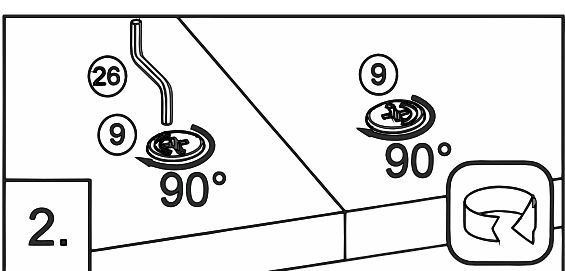
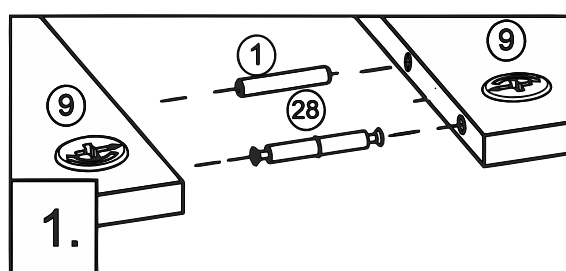
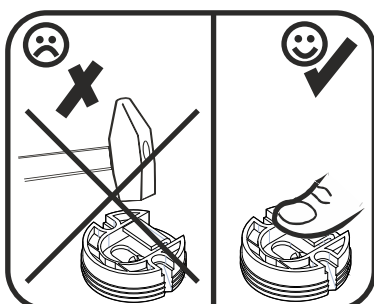
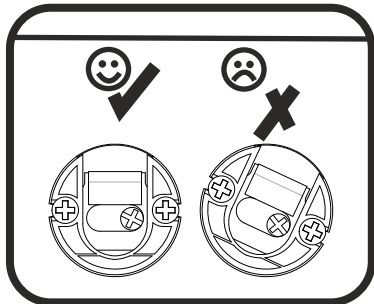
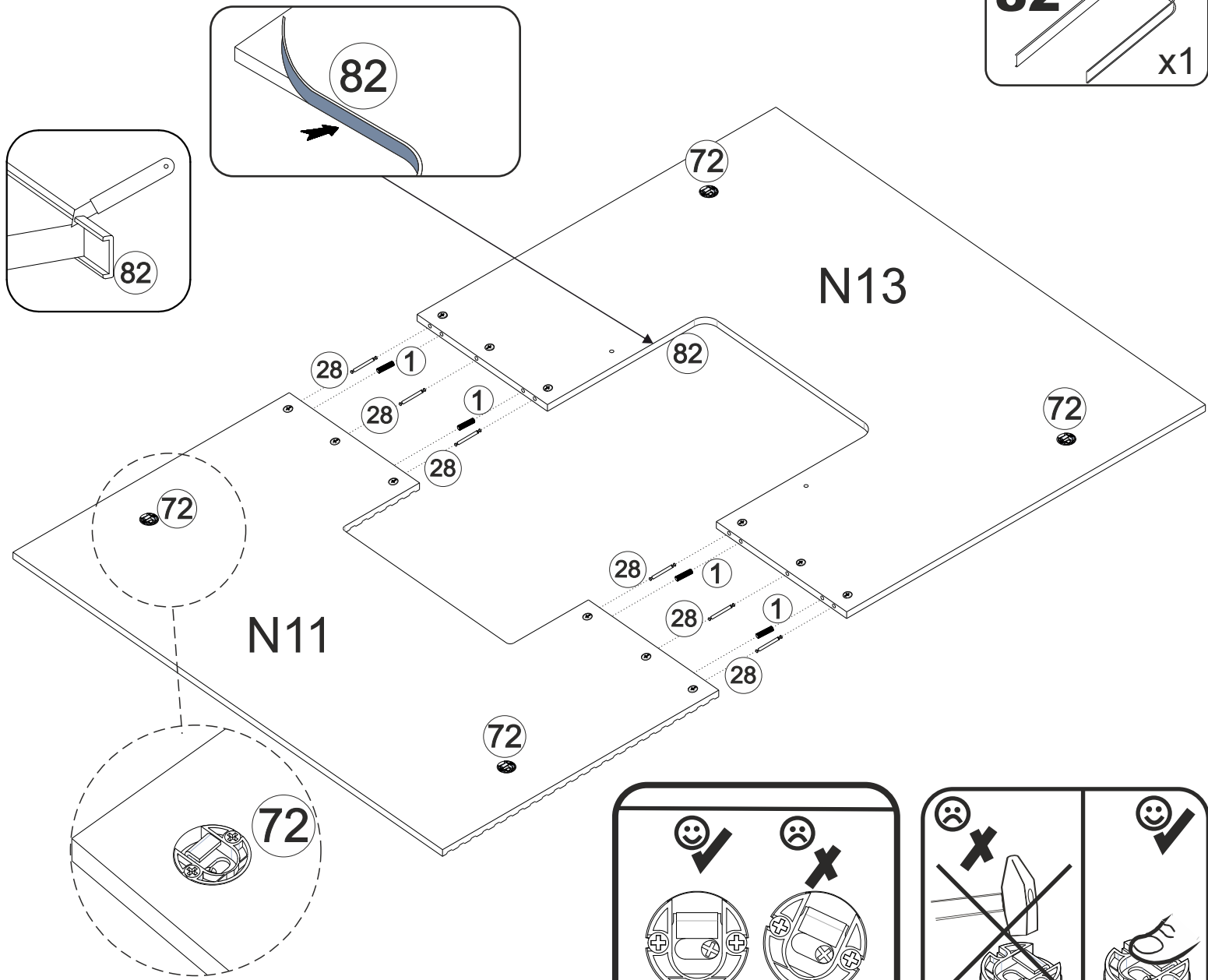
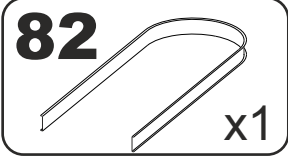
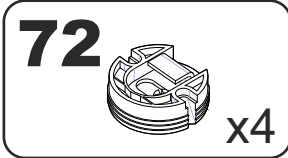
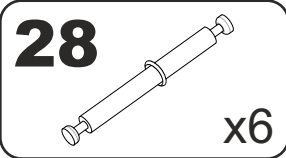
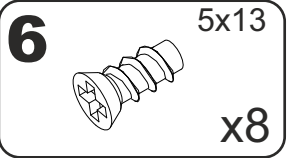
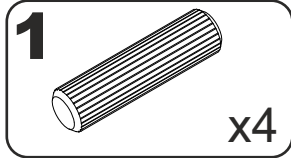

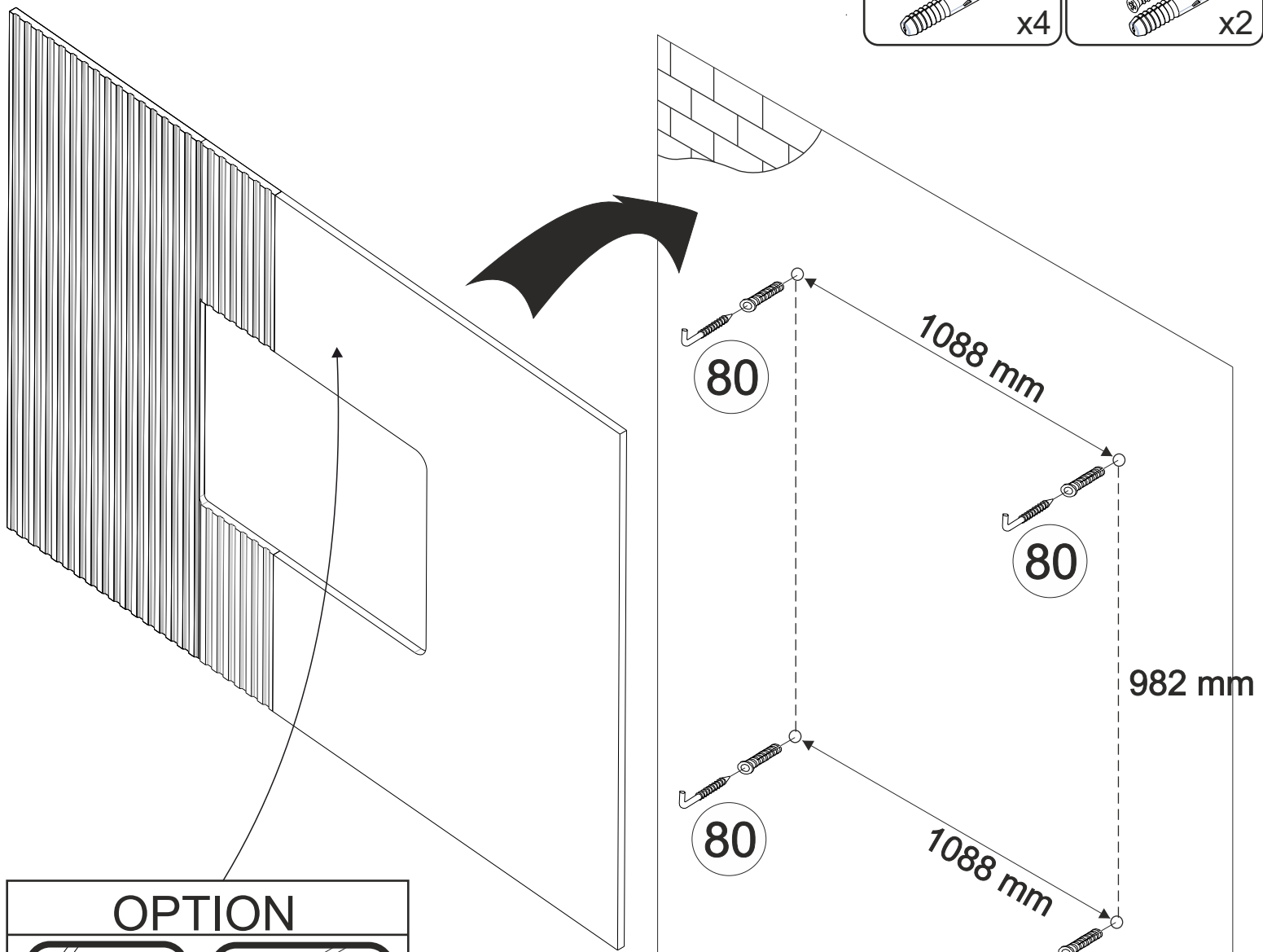
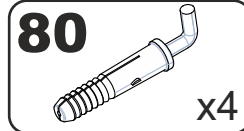

OPTION

<p>N13 ø8</p>	<p>80A</p>

--	--

4mm

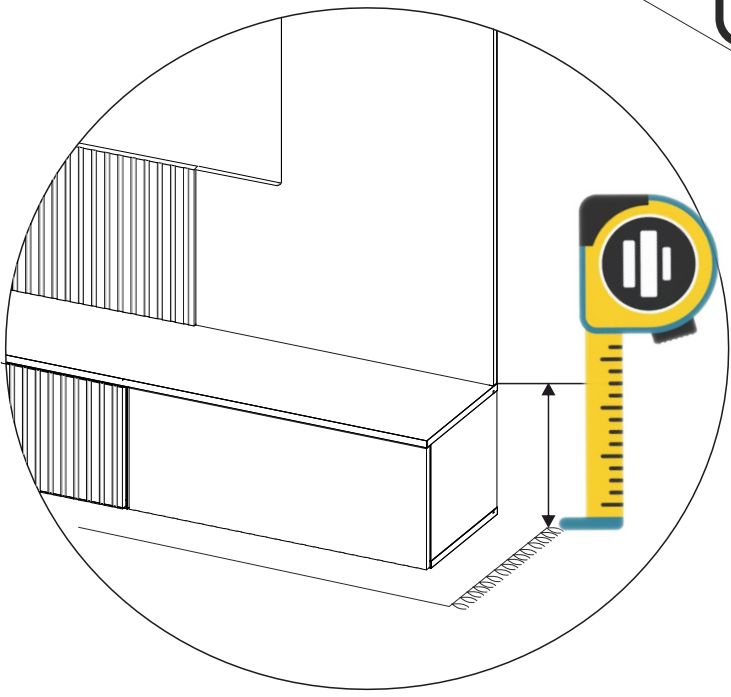
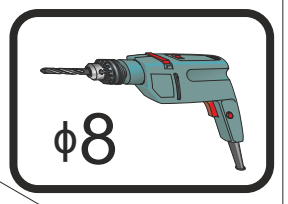

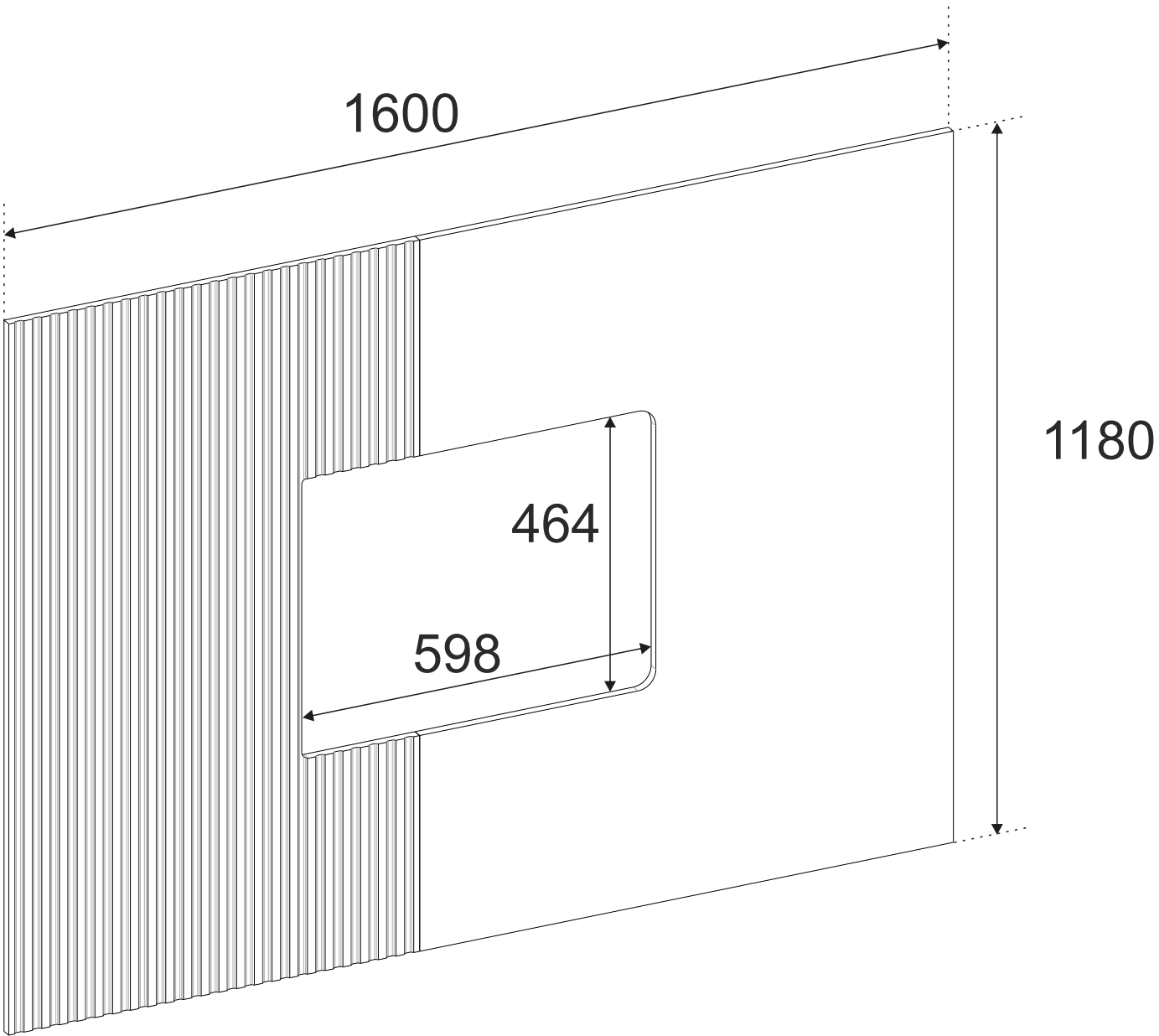
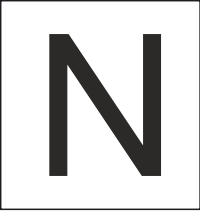

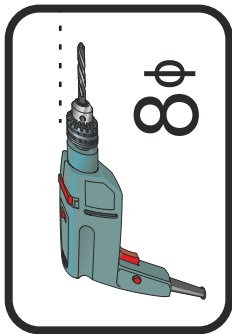

8φ

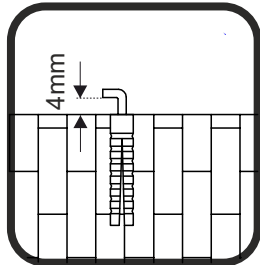
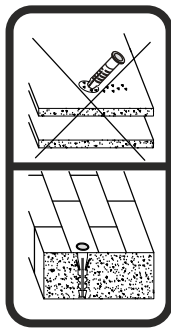

4mm

