

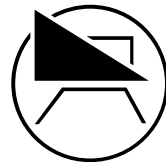

INDI POLICKA

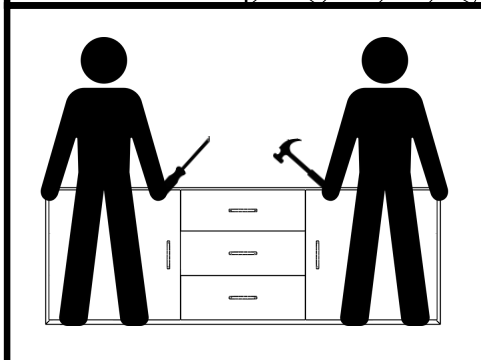

INSTRUKCJA MONTAŻU • ASSEMBLY INSTRUCTION • MONTAGEANLEITUNG

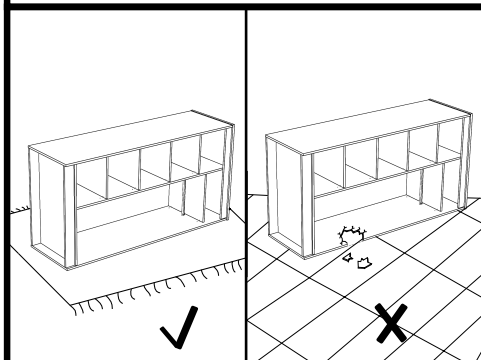
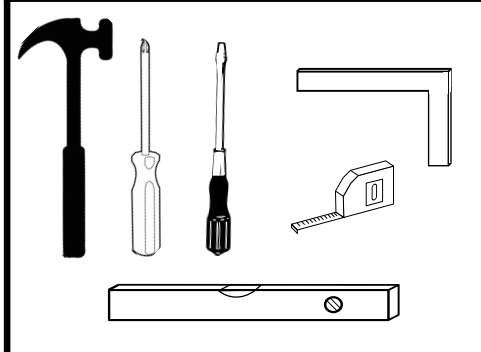
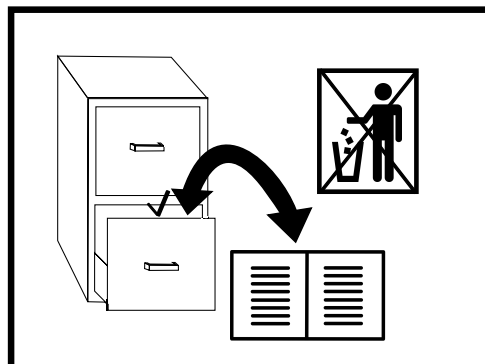
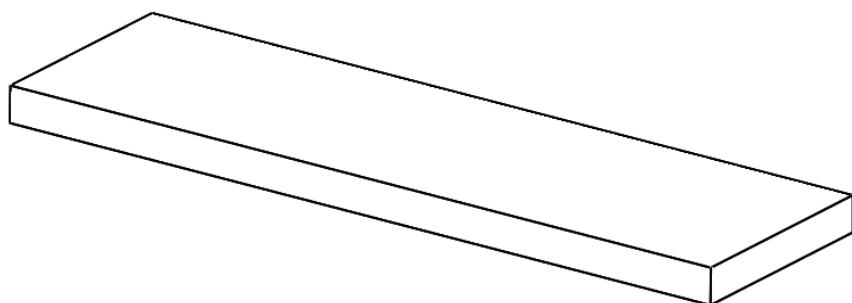

IN-06-C

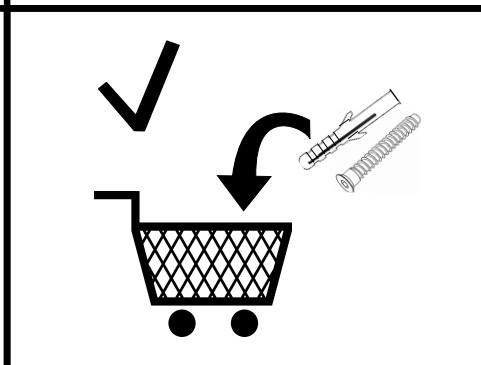
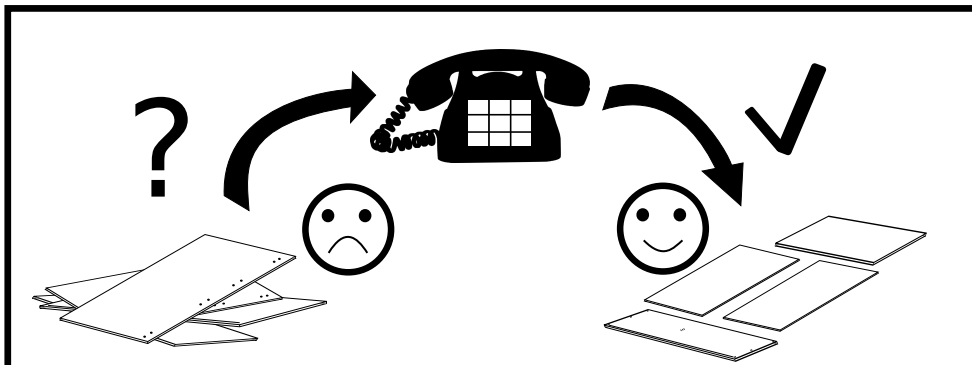

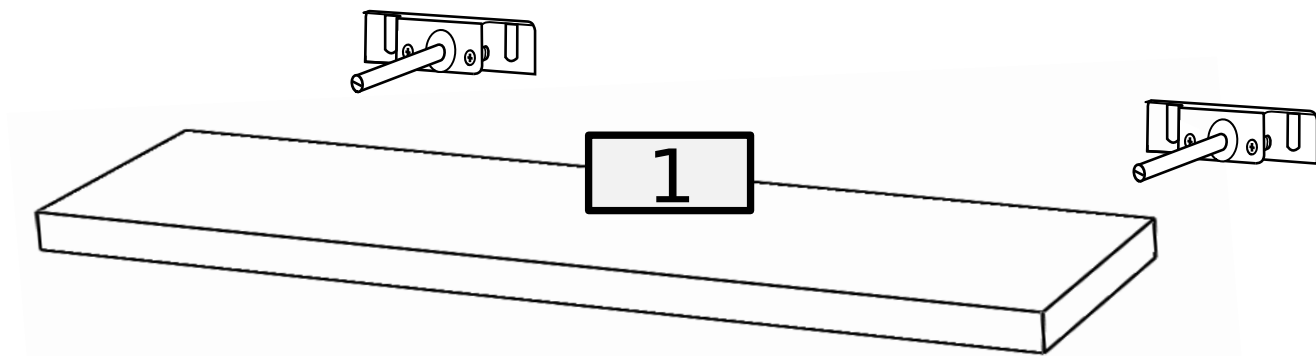

No.	Pcs.	L	W	D	Pac
1	1	680	200	32	1/1

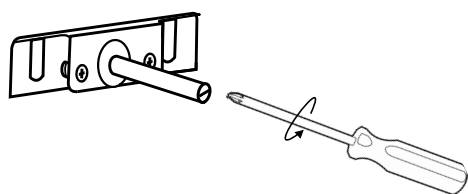
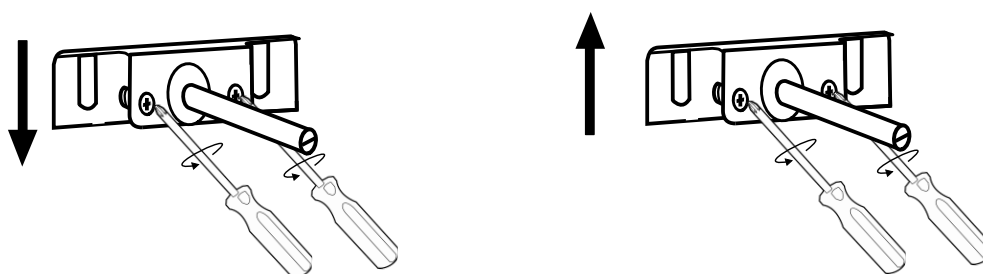
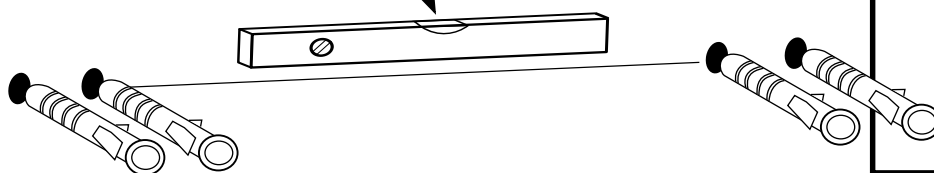
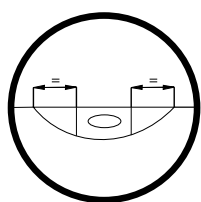
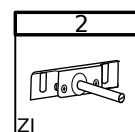

1

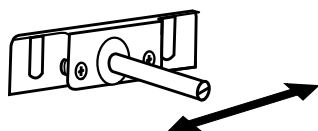

2

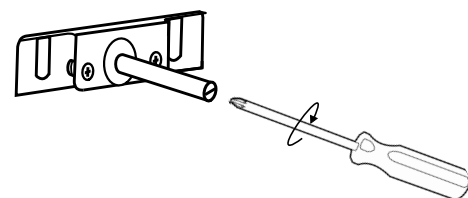

3

